

YAMAHA

MIXING CONSOLE

GA32/12

GA24/12

Owner's Manual

Precautions

1. **Avoid excessive heat, humidity, dust and vibration**
Keep the unit away from locations where it is likely to be exposed to high temperatures or humidity — such as near radiators, stoves, etc. Also avoid locations which are subject to excessive dust accumulation or vibration which could cause mechanical damage.
2. **Ventilation**
The unit has ventilation slots on the top, rear and bottom panels. Do not block these vents.
3. **Avoid physical shocks**
Strong physical shocks to the unit can cause damage. Handle it with care.
4. **Do not open the case or attempt repairs or modifications yourself**
This product contains no user-serviceable parts. Refer all maintenance to qualified Yamaha service personnel. Opening the case and/or tampering with the internal circuitry voids the warranty.
5. **Always power off before making connections**
Always turn the power OFF before connecting or disconnecting cables. This is important to prevent damage to the unit itself as well as other connected equipment.

IMPORTANT NOTICE FOR THE UNITED KINGDOM

Connecting the Plug and Cord

WARNING: THIS APPARATUS MUST BE EARTHED

IMPORTANT: The wires in this mains lead are coloured in accordance with the following code:

GREEN-AND-YELLOW	: EARTH
BLUE	: NEUTRAL
BROWN	: LIVE

As the colours of the wires in the mains lead of this apparatus may not correspond with the coloured markings identifying the terminals in your plug, proceed as follows:

The wire which is coloured GREEN and YELLOW must be connected to the terminal in the plug which is marked by the letter E or by the safety earth symbol or coloured GREEN and YELLOW.

The wire which is coloured BLUE must be connected to the terminal which is marked with the letter N or coloured BLACK.

The wire which is coloured BROWN must be connected to the terminal which is marked with the letter L or coloured RED.

* This applies only to products distributed by YAMAHA KEMBLE MUSIC (U.K.) LTD.

6. **Handle cables carefully**
Always plug and unplug cables — including the AC power cord — by gripping the connector, not the cord.
7. **Clean with a soft dry cloth**
Never use solvents such as benzine or thinner to clean the unit. Wipe clean with a soft, dry cloth.
8. **Always use the correct power supply**
Make sure that the power supply voltage specified on the rear panel matches your local AC mains supply. Also make sure that the AC mains supply can deliver more than enough current to handle all equipment used in your system.

Contents

Introduction	1
Features.....	1
Front Panel	2
Monaural input channels.....	2
Stereo input channels.....	4
Master Section	6
Variable/Fix select section.....	6
Mix section	6
ST (Stereo) section	9
AUX RETURN section.....	10
MATRIX section.....	11
C-R MONI (Control room monitor) section	
PHONES (headphones) section.....	12
TAPE IN section.....	13
TALKBACK section	14
METER SELECT section.....	15
Meter bridge	15
Rear Panel	16
GA Diversity Function	19
What is GA Diversity?.....	19
Setting the GA Diversity function	19
Specifications	20
General specifications	20
Input specifications	21
Output specifications	21
Dimensions.....	22
Block and Level diagram.....	23

Introduction

Thank you for choosing the Yamaha GA32/12 or GA24/12 mixing console. Please read this manual thoroughly to take best advantage of the console and extend its useful life.

Notes:

This manual has been written on the assumption that you already understand the basic operation and technical terminology of mixing consoles.

Descriptions of GA24/12 specifications appear in brackets ({}), if they differ from the GA32/12.

Features

- The GA32/12 provides 28 monaural and 2 stereo input modules {the GA24/12 provides 20 monaural and 2 stereo input modules}. The output channels comprise stereo outputs, 10 mix outputs, and two matrix outputs, and support a wide range of applications, from SR (sound reinforcement) to facility acoustics.
 - Each monaural input channel offers a 26 dB pad, HPF, phase switch, 4-band EQ (HI-MID and LO-MID frequencies are variable), and a 100 mm-long full-stroke fader. Also, phantom power can be turned on and off for every group of four inputs.
 - Four stereo AUX returns and TAPE IN jacks are provided as standard.
 - The master section of the console is located in the center area of the unit, facilitating operation.
 - The master section provides output channels for MIX buses 1–10, with EQs and 100 mm-long faders.
 - Each input channel and four stereo AUX returns include a PFL switch, and stereo bus, MIX buses 1–10, and Matrix 1–2 has an AFL switch, enabling you to monitor the input/output sources quickly.
 - Using the GA Diversity function enables you to set MIX buses 1–4 to Variable mode or Fix mode individually. In Variable mode, you can change the level of the signals sent out from the input channels. This routing can be used as a conventional AUX bus. In Fix mode, the level of the signals sent out from the input channels is fixed.
- This routing can be used as a conventional group bus. In this way, you can configure the bus for a specific purpose.
- The console has two independent matrixes. You can mix MIX buses 1–4 and the stereo bus individually at the levels you desire and output them from the MATRIX OUT 1–2 jacks. This routing can be used as a mix for the foldback or for individual speakers and amplifiers.
 - The INSERT I/O jacks are provided for all monaural input channels, the stereo bus, and MIX buses 1–4. You can insert an external effect processor, if necessary.
 - Talkback signals can be sent to any of MIX buses 1–4, MIX buses 5–10, and the stereo bus.
 - C-R monitor output enables you to select PFL/AFL or TAPE IN as a monitoring source.
 - The console's sturdy finish and rugged design assure its durability even under severe conditions and rough on-site usage.

Front Panel

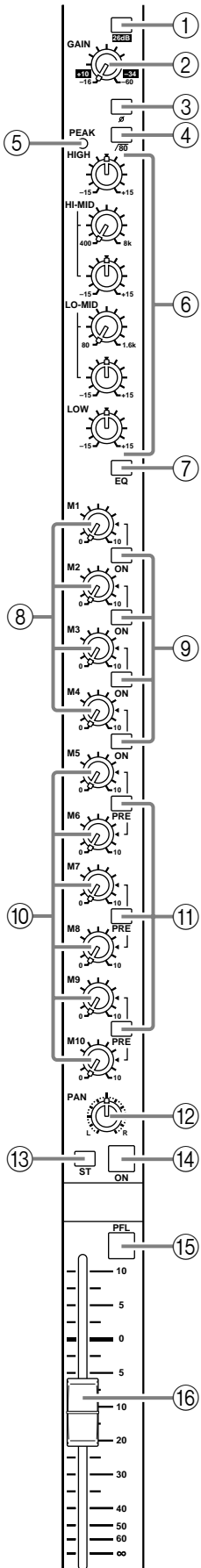

Monaural input channels

The GA32/12 {GA24/12} has 28 {20} monaural input channels. They are located on both sides of the master section and feature the same specifications.

A Pad switch

This switch is used to attenuate input signals by 26 dB. Press down the switch to turn the pad on.

B GAIN control

This control knob is used to adjust input sensitivity. The adjustable range is -16 dB to -60 dB when the pad switch 1 is turned off, and +10 dB to -34 dB when the pad switch is turned on.

C Ø (Phase) switch

This switch reverses the phase of input signals. Press down this switch to reverse the phase.

D High pass filter switch

This high pass filter is used to cut the frequency range below 80 Hz with a slope of 12 dB/oct. Press down the switch to turn the high pass filter on.

E PEAK indicator

This indicator lights up when the level of signals that pass the EQ reaches 3 dB below the clipping level.

F EQ controls (HIGH/HI-MID/LO-MID/LOW)

This 4-band equalizer provides ±15 dB of cut and boost over each range, with the center frequencies and types shown in the following table. The frequencies for HI-MID and LO-MID are variable.

Band	Center frequencies	Type
HIGH	10 kHz	shelving
HI-MID	400 Hz–8 kHz	peaking (parametric)
LO-MID	80 Hz–1.6 kHz	peaking (parametric)
LOW	100 Hz	shelving

G EQ switch

This switch is used to turn equalization on and off. Press down the switch to turn equalization on.

H M1–M4 mix level controls

These controls are used to route the post fader signals from the input channel to MIX buses 1–4.

Note: When you press down the M1–M4 switches to the FIX position in the Variable/Fix select section (see page 6), the output level of the signals routed to the MIX buses will be fixed and the corresponding M1–M4 mix level controls will be disabled.

I ON switches

These switches are used to turn on and off the signals routed from the input channel to MIX buses 1–4.

Note: When these switches are set to off, no signals will be sent from the input channel to the corresponding MIX buses regardless of the setting of the switches in the Variable/Fix select section (see page 6).

J M5–M10 mix level controls

These controls route the input channel signals to MIX buses 5–10. Use the PRE switches K to select pre- or post-fader.

K PRE switches

These switches are used to select pre- or post-fader for signals sent from the input channel to MIX buses 5–10. Each switch is effective for one pair of MIX buses: 5/6, 7/8, or 9/10. When you turn these switches on, the pre-fader signals will be sent to the corresponding MIX bus pair.

L PAN control

This control is used to set the stereo image of signals sent from the input channel to the ST (stereo) buses.

M ST (Stereo) switch

When you turn this switch on, input channel signals are sent to the ST buses.

N ON switch

This switch is used to turn on and off the corresponding input channel module. When this switch is turned off, no signals are sent from the corresponding input channel to the ST buses and MIX buses 1–10. However, using the PFL switch \bigcirc will enable you to monitor the signals via the C-R MONITOR OUT jacks or PHONES jack.

O PFL (Pre-fader Listen) switch

When you turn this switch on, the pre-fader signals of the input channel are routed to the PFL bus, and you are able to monitor the signals via the C-R MONITOR OUT jacks or PHONES jack.

P Channel fader

This fader is used to adjust the level of the input channel signals. This fader setting affects the level of the signals routed to the ST buses, MIX buses 1–4, and MIX buses 5–8 (when the PRE switches are turned off).

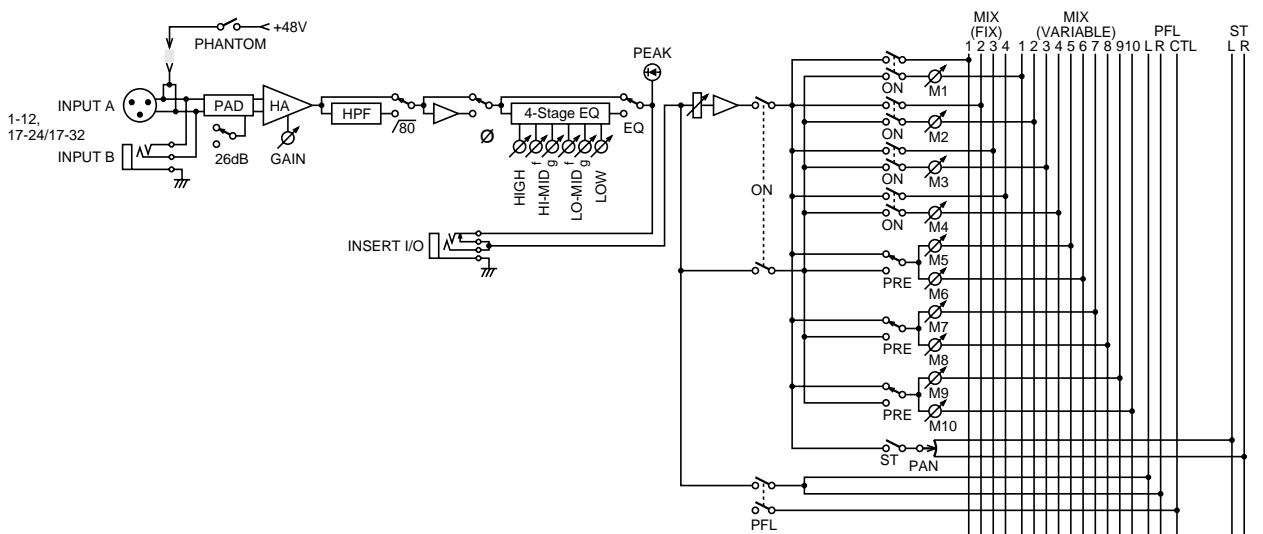

Signal flow of the monaural input channel

Stereo input channels

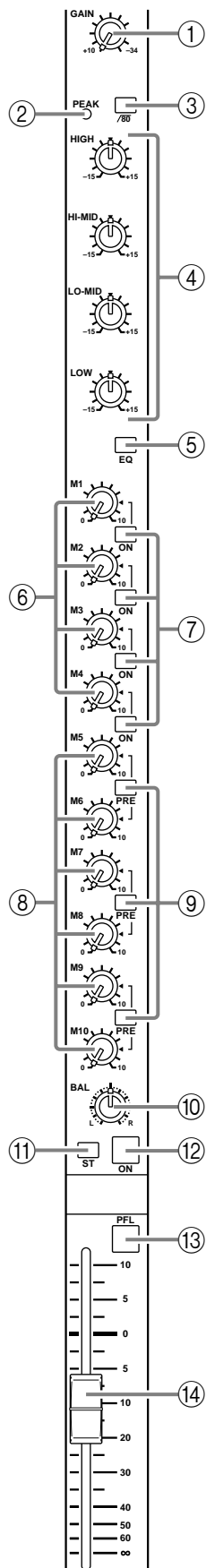

The GA32/12 and GA24/12 provide two stereo input channel modules. Use the paired INPUT 13/14 and 15/16 jacks (see page 17, rear panel 5) to input stereo signals. If you connect signals only to the 13L (MONO) jack or 15L (MONO) jack, the same signal will be sent to the M1–4 and ST buses.

A GAIN control

This control is used to adjust input sensitivity. The adjustable range is +10 dB to –34 dB.

B PEAK indicator

This indicator lights up when the level of signals that have been processed by the EQ reaches 3 dB below the clipping level.

C High pass filter switch

This high pass filter is used to cut the frequency range below 80 Hz with a slope of 12 dB/oct.

D EQ controls (HIGH/HI-MID/LO-MID/LOW)

This 4-band equalizer provides ±15 dB of cut and boost over each range, with the center frequencies and types shown in the following table.

Band	Center frequencies	Type
HIGH	10 kHz	shelving
HI-MID	3 kHz	peaking
LO-MID	800 Hz	peaking
LOW	100 Hz	shelving

E EQ switch

This switch is used to turn the equalization on and off.

F M1–M4 mix level controls

These controls are used to route the post fader signals from the stereo input channel to MIX buses 1–4. When stereo signals are input, the L channel signal will be sent to MIX buses 1, 3, and the R channel signal will be sent to MIX buses 2 and 4.

Note: When you press down the M1–M4 switches to the FIX position in the Variable/Fix select section (see page 6), the output level of signals sent to the MIX buses will be fixed and the corresponding M1–M4 mix level controls will be disabled.

G ON switches (M1–M4)

These switches are used to turn on and off the signals routed from the stereo input channel to MIX buses 1–4.

Note: When these switches are set to off, no signals are sent from the stereo input channel to the corresponding MIX buses regardless of the setting of the switches in the Variable/Fix select section (see page 6).

H M5–M10 mix level controls

These control knobs route the stereo input channel signals to MIX buses 5–10. Stereo input signals are mixed into a monaural signal and sent to MIX buses 5–10. Use the PRE switches ⊖ to select pre- or post-fader.

I PRE (Pre-fader) switches

These switches are used to select pre- or post-fader for signals sent from the stereo input channel to MIX buses 5–10. Each switch is effective for one pair of MIX buses: 5/6, 7/8, or 9/10. When you turn these switches on, the pre-fader signals are sent to the corresponding MIX bus pair.

J BAL (Balance) control

This control is used to adjust the left and right balance of signals sent from the stereo input channel to the ST bus.

K ST (Stereo) switch

When you turn this switch on, the stereo input channel signals will be sent to the ST bus. If you connect monaural signals to the 13L (MONO) jack or 15L (MONO) jack (see page 17, rear panel 5), the same signals will be sent to both L and R channels.

L ON switch

This switch is used to turn on and off the corresponding stereo input channel. When this switch is turned off, no signals are sent to the ST bus and MIX buses 1–10. However, using the PFL switch M will enable you to monitor the signals via the C-R MONITOR OUT jacks or PHONES jack.

M PFL (Pre-fader listen) switch

When you turn this switch on, the pre-fader signals of the stereo input channel are routed to the PFL bus, and you can monitor the signals via the C-R MONITOR OUT jacks or PHONES jack.

N Channel fader

This fader is used to adjust the level of the stereo input channel signals. This fader setting affects the level of the signals routed to the ST bus, MIX buses 1–4, and MIX buses 5–8 (when the PRE switches are turned off).

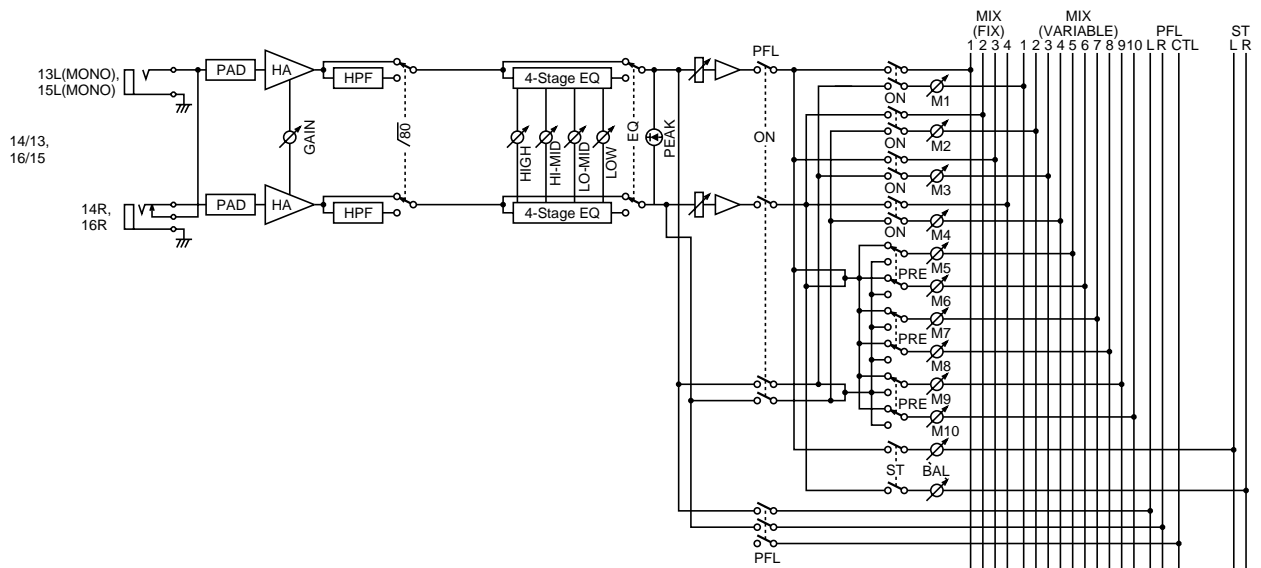

Signal flow of the stereo input channel

Master Section

Variable/Fix select section

The GA32/12 and GA24/12 feature a GA (Group/Aux) diversity function, which enables you to use the MIX bus 1–4 signals as group bus signals or AUX bus signals. This section of the console allows you to select whether you wish to use MIX buses 1–4 as group buses or AUX buses.

A M1–M4 switches

These switches are used to select whether the level of signals sent from the input channels to MIX buses 1–4 will be fixed (FIX) or variable (VARIABLE).

■ When FIX is on:

The selected MIX bus(es) function as a group bus. The level of the signal from each input channel will be fixed, and the M1–M4 mix level controls of the input channels that correspond to the MIX buses will be disabled.

■ When FIX is off:

The selected MIX bus(es) function as an AUX bus. Signals that pass through the M1–M4 mix level controls of each input channel (see page 2, monaural input channel 8 , and page 4, stereo input channel 6) are sent to the corresponding MIX buses.

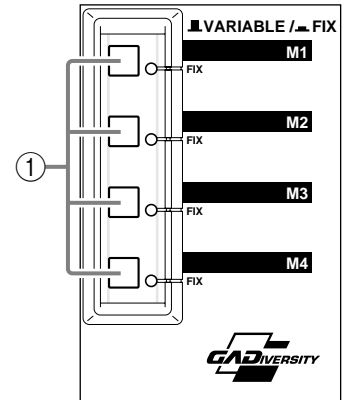

Mix section

This section consists of the output channels that handle MIX bus 1–10 signals individually. Signals that pass these output channels are output from MIX OUT 1–10 jacks (see page 17, rear panel 6), and also routed to the AFL bus. MIX bus 1–4 signals are also routed to the ST bus and Matrixes 1/2.

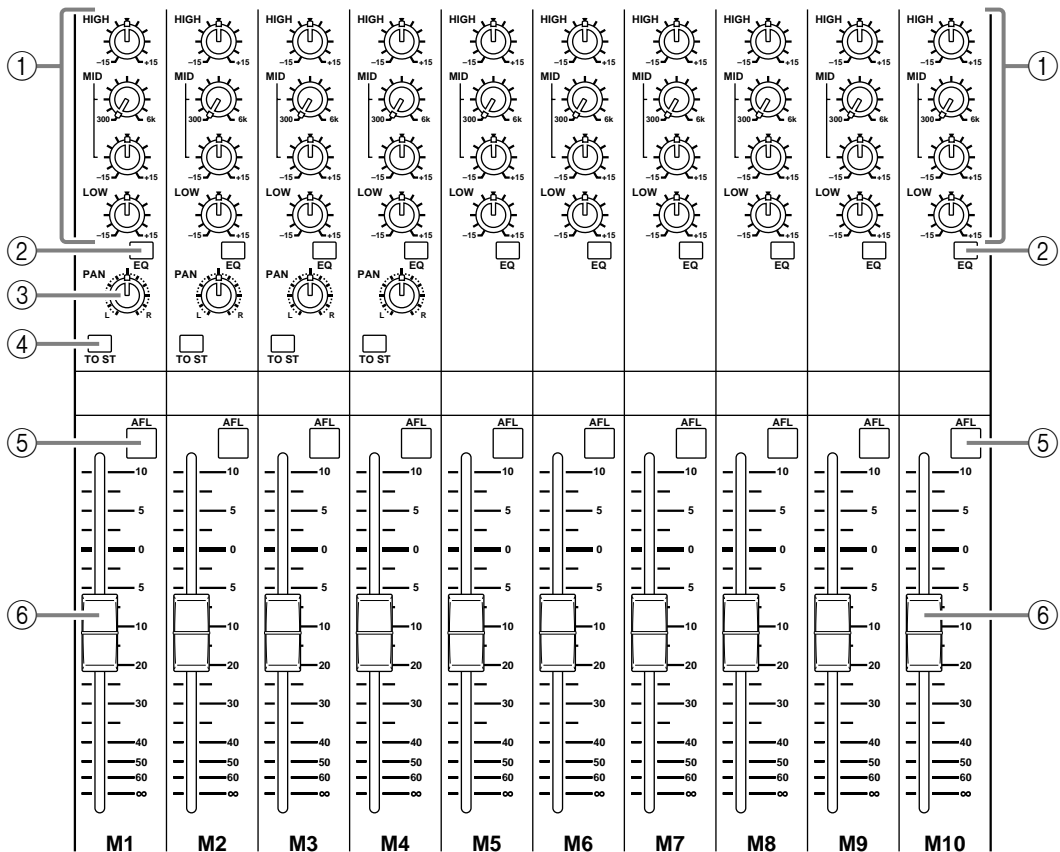

■ M1–M4

These modules function as output channels for either a group bus or an AUX bus, depending on the setting of the switches in the Variable/Fix select section. The MIX bus 1–4 signals that pass these output channels can be routed to MIX OUT 1–4 jacks, ST bus, AFL bus, and Matrixes 1/2.

■ M5–M10

These modules function as output channels for an AUX bus. The MIX bus 5–10 signals that pass these output channels can be routed to MIX OUT 5–10 jacks and AFL bus.

A EQ controls (HIGH/MID/LOW)

This 3-band equalizer provides ± 15 dB of cut and boost over each frequency range of the MIX bus signals, with center frequencies and types shown in the following table. The frequencies for MID are variable.

Band	Center frequencies	Type
HIGH	10 kHz	shelving
MID	300–6 kHz	peaking (parametric)
LOW	100 Hz	shelving

B EQ switch

This switch is used to turn the equalization on and off.

C PAN control (applied only to M1–M4)

This control allows you to adjust the stereo position of signals routed from MIX buses 1–4 to the ST bus.

D TO ST (To stereo) switch (applied only to M1–M4)

When you turn this switch on, the MIX bus 1–4 signals will be sent to the ST bus.

E AFL (After-Fader Listen) switch

When you turn this switch on, the post-fader signals in the MIX buses are routed to the AFL bus, and you can monitor the signals via the C-R MONITOR OUT jacks or PHONES jack.

F Mix master fader

This fader adjusts the output level of the MIX buses. The settings of the M1–M4 faders affect the level of signals sent to MIX OUT 1–4 jacks, ST bus, AFL bus, and Matrixes 1/2. The settings of the M5–M10 faders affect the level of signals sent to the MIX OUT 5–10 jacks and AFL bus.

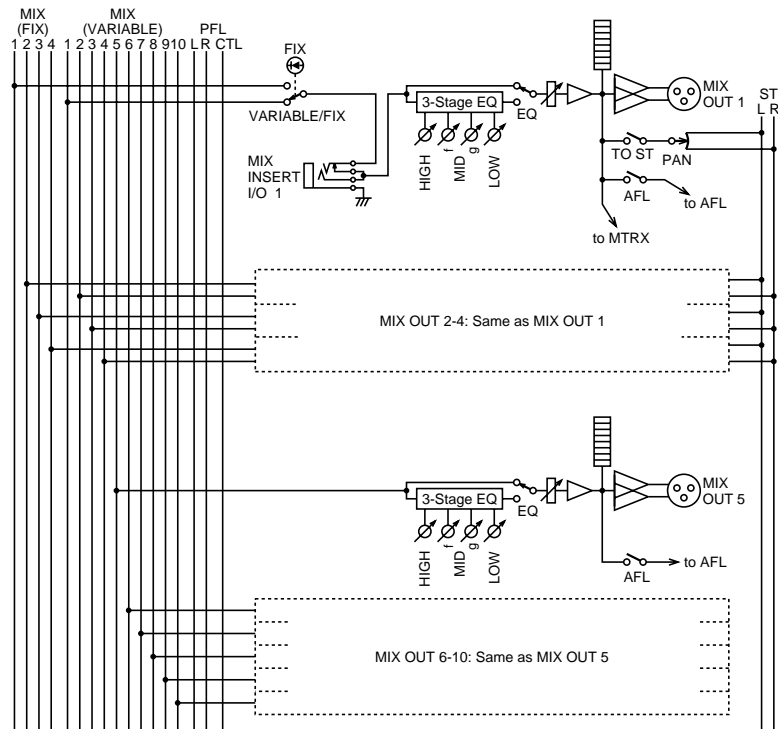

Signal flow in the Variable/Fix select section and Mix section

ST (Stereo) section

This section enables you to control the ST bus signals output from the ST1 OUT jacks (see page 17, rear panel \ominus) and ST2 OUT jacks (see page 17, rear panel J).

A POST ST1 (Post stereo 1) switch

This switch toggles between pre- and post-fader for signals output from the ST2 OUT jacks. When you turn this switch on, signals that passed the ST fader are output from the ST2 OUT jacks. When you turn the switch off, the ST fader setting does not affect signals output from the ST2 OUT jacks.

B MONO (Monaural) switch

When you turn this switch on, the ST bus signals will be mixed into a monaural signal and output from the ST2 OUT jacks. This switch setting does not affect signals output from the ST1 OUT jacks.

C LEVEL control

This control enables you to adjust the output level of signals at the ST2 OUT jacks. It does not affect the level of signals output from the ST1 OUT jacks.

D AFL (After-fader Listen) switch

When you turn this switch on, the ST bus post-fader signals are routed to the AFL bus, and you can monitor the signals via the C-R MONITOR OUT jacks or PHONES jack.

E ST (Stereo) fader

This fader enables you to adjust the final output level of the ST bus signals. This fader setting affects the level of the signals routed to the ST1 OUT jacks, ST2 OUT jacks (when the POST ST1 switch is turned on), and the AFL bus.

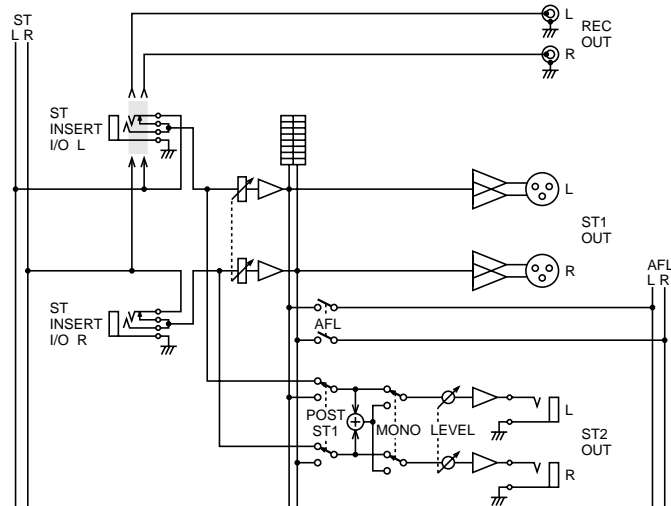
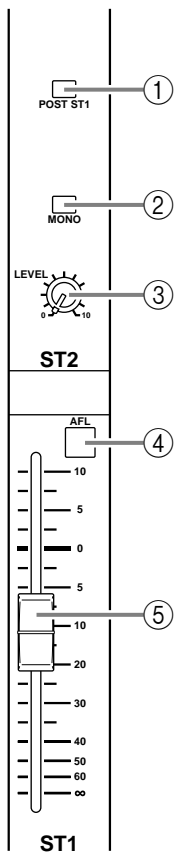

Signal flow in the ST section

AUX RETURN section

The GA32/12 and GA24/12 provide four stereo AUX returns. Use the paired AUX RETURN 1–4 L/R jacks (see page 17, rear panel 8) to input stereo signals. Alternatively, connect signals only to the AUX RETURN 1–4's L jack to use the routing as a monaural AUX return.

A M1–M4 mix level controls

These controls are used to route signals input from the AUX RETURN 1–2 jacks to MIX buses 1–4. The L channel of a stereo input signal is sent to MIX buses 1 and 3, and the R channel signal is sent to MIX buses 2 and 4. For a monaural signal input, the same signal is sent to MIX buses 1–4.

B M5–M10 mix level controls

These controls route the input channel signals at the AUX RETURN 3–4 jacks to MIX buses 5–10. The L channel of a stereo input signal is sent to MIX buses 5, 7, and 9, and the R channel signal is sent to MIX buses 6, 8, and 10.

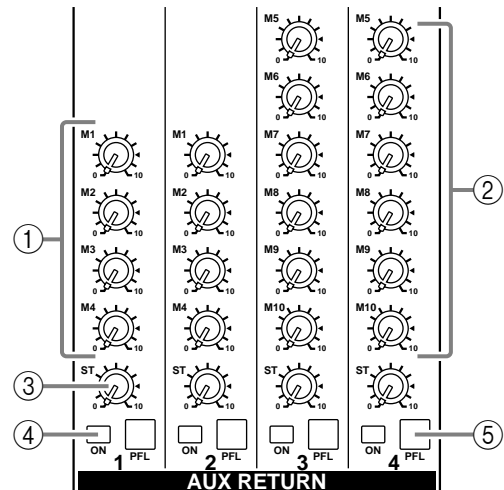

Note: The M1–M4 switch settings in the Variable/Fix select section do not affect the M1–M10 mix level control settings. If the switches are set to FIX, signals that pass the M1–M10 mix level controls will still be sent to MIX buses 1–10.

C ST (Stereo) level control

This control knob enables you to adjust the level of signals sent from the AUX RETURN 1–4 jacks to the ST bus, and does not affect the M1–M10 mix level control settings (1 and 2).

D ON switch

This switch is used to turn on and off the corresponding AUX return. When you turn this switch off, no signals are sent to the ST bus and MIX buses 1–10. However, using the PFL switch 5 enables you to monitor the signals via the C-R MONITOR OUT jacks or PHONES jack.

E PFL switch

When you turn this switch on, the AUX return signals will be routed to the PFL bus, and you can monitor the signals via the C-R MONITOR OUT jacks or PHONES jack. The signals are not affected by the M1–M10 mix level controls (1 and 2), ST level control (3), or ON switch (4).

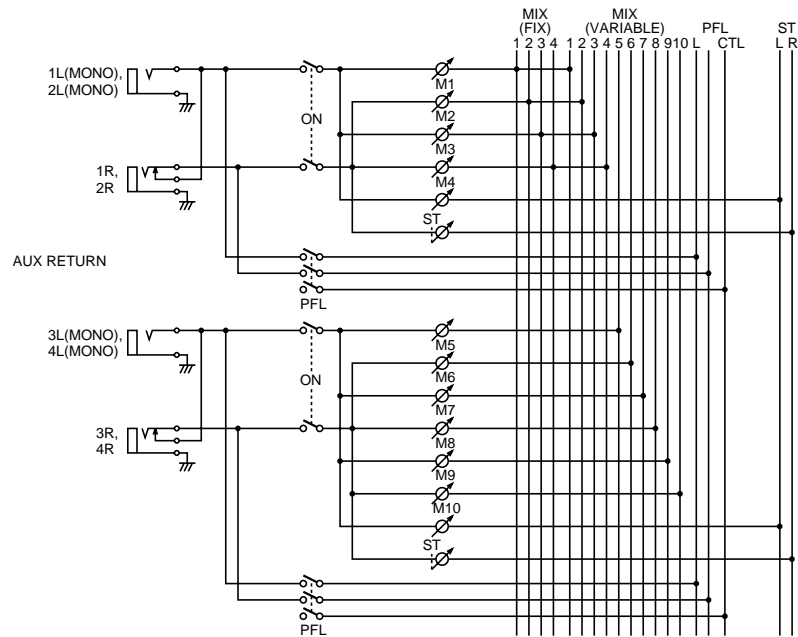

Signal flow in the AUX RETURN section

MATRIX section

The GA32/12 and GA24/12 provide two matrix modules that allow you to mix MIX buses 1–4 and ST bus signals at desired levels. Matrix 1–2 signals are output in monaural via the MATRIX OUT 1–2 jacks (rear panel K).

A M1–M4 level controls

These control knobs enable you to adjust the input level of MIX bus 1–4 post-fader signals.

B L/R controls

These control knobs enable you to adjust the input level of the ST bus post-fader signals for the L channel and R channel independently.

C LEVEL control

This control knob enables you to adjust the output level of Matrix 1–2 signals.

D ON switch

This switch turns on and off Matrixes 1–2. When you turn this switch off, the corresponding matrix signal is not output from the MATRIX OUT jack. The signal is not sent to the AFL bus, either.

E AFL (After-fader Listen) switch

When you turn this switch on, the matrix 1–2 post-fader signals are sent to the AFL bus. You can monitor the signals via the C-R MONITOR OUT jacks or PHONES jack. However, this switch will be disabled if the ON switch (4) is turned off.

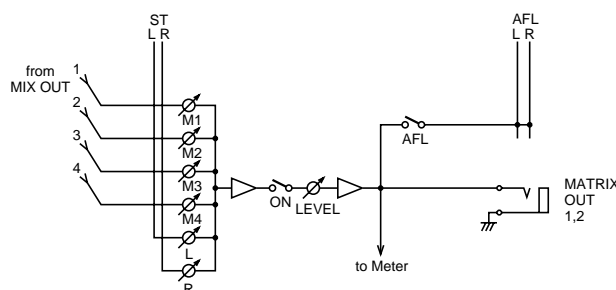
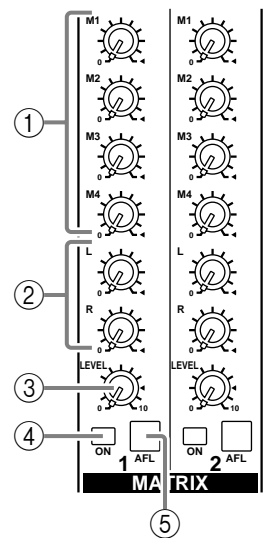

Signal flow in the MATRIX section

C-R MONI (Control room monitor) section PHONES (headphones) section

This section enables you to control signals monitored via the C-R MONITOR OUT jacks (see page 18, rear panel M) and the PHONES jack on the front panel (C-R MONI section/ PHONES section G).

A Monitor source select switch

This switch enables you to select the type of signal to monitor via the C-R MONITOR OUT jacks and the PHONES jack.

■ When the switch is set to PFL/AFL ()

You will monitor PFL signals (signals routed from input channels/AUX returns to the PFL bus) or AFL signals (signals routed from MIX buses 1–10/ST buses/MATRIX 1–2 to the AFL bus).

If any one of the PFL switches for the input channels/AUX returns is turned on, the PFL indicator  will light up. In this case, the PFL bus signals (not the AFL bus signals) are routed to the C-R MONITOR OUT jacks and PHONES jack. If all the PFL switches are turned off, the AFL bus signals are sent to the C-R MONITOR OUT jacks and PHONES jack.

Note: If you turn on any one of the PFL switches for the input channels/AUX returns while monitoring the AFL bus signal, the switching circuit will switch the signal to the PFL bus signal.

■ When the switch is set to TAPE IN ()

You can monitor the signals input from the TAPE IN jacks (see page 18, rear panel N).

B PFL (Pre-fader Listen) indicator

This indicator lights up when any one of the PFL switches for the input channels/AUX returns is turned on, indicating that the PFL bus signal is currently being monitored.

C LEVEL control

This control enables you to adjust the level of signals output from the C-R MONITOR OUT jacks. This setting does not affect the signal level at the PHONES jack.

D ON switch

This switch turns on and off the monitoring signals output from the C-R MONITOR OUT jacks. It does not affect signals at the PHONES jack.

E LEVEL (Headphones level) control

This control enables you to adjust the level of signals output from the PHONES jack. This setting does not affect the signal level at the C-R MONITOR OUT jacks.

F PHONES (Headphones) jack

Connect monitoring stereo headphones here. See the figure on the right for wiring.

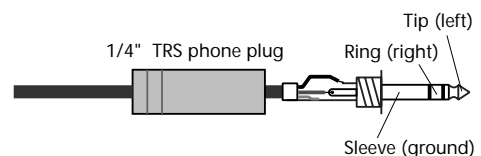
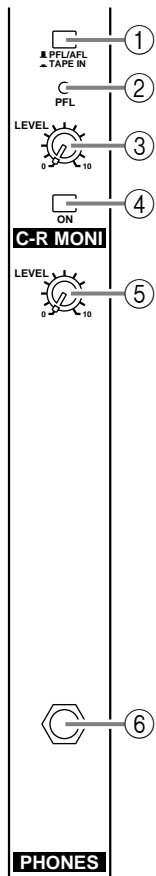

TAPE IN section

This section enables you to control line-level signals input from the TAPE IN jacks. Input signals from the TAPE IN jacks can be routed to the ST bus or directly to the C-R MONITOR OUT jacks and PHONES jack.

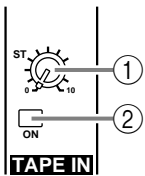

A ST (Stereo) control

This control knob determines the level of input signals at the TAPE IN jacks that are sent to on the ST buses.

B ON switch

This switch turns on and off the signals sent from the TAPE IN jacks to the ST bus. This switch setting does not affect signals (input from the TAPE IN jacks) that are monitored via the C-R MONITOR OUT jacks and PHONES jack.

Note: Set the Monitor source select switch (C-R MONI section 1) in the C-R MONI section to "TAPE IN" to monitor the TAPE IN signals via the C-R MONITOR OUT jacks and PHONES jack.

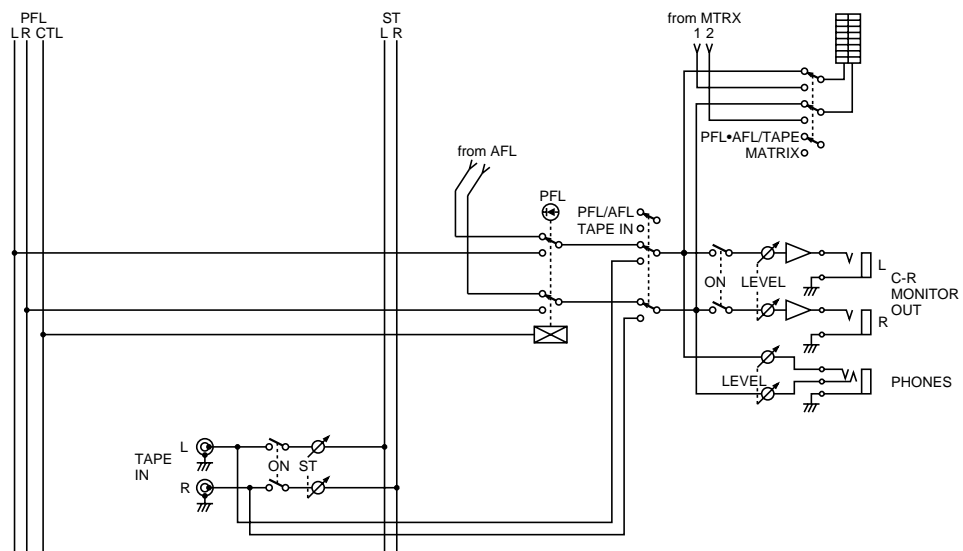

Signal flow in the C-R MONI section, PHONES section, and TAPE IN section

TALKBACK section

This section is used to route talkback signals to the MIX buses and the ST bus.

A INPUT jack

This XLR-3-31 unbalanced input jack is used to connect a talkback microphone with an output impedance of 50–600Ω. See the figure below for wiring.

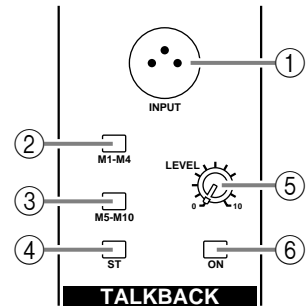
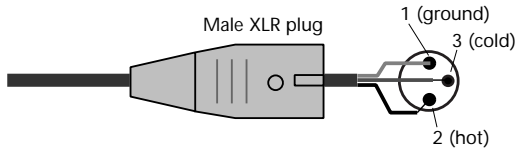

B M1-M4 switch

C M5-M10 switch

D ST switch

These switches (2–4) are used to send talkback signals to MIX buses 1–4, MIX buses 5–10, and ST bus. You can turn the switches on or off independently for each destination.

E LEVEL control

This control knob is used to adjust the talkback level.

F ON switch

This switch turns talkback signals on and off.

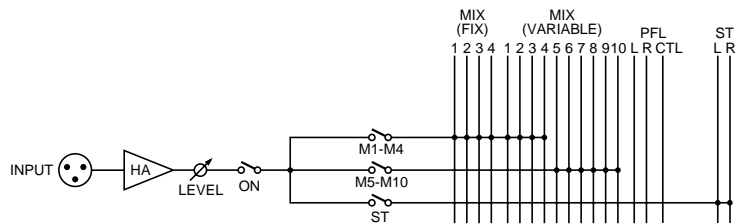

Signal flow in the TALKBACK section

METER SELECT section

You can select the signal source to be displayed in the Meter bridge section.

A Source select switch

This switch enables you to select the signal source to be displayed on the MATRIX (PFL•AFL/TAPE) meter (Meter bridge 3) in the right corner of the level meter.

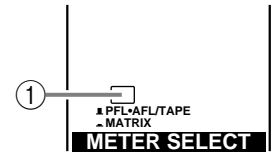

■ When the switch is set to PFL-AFL/TAPE ()

The meter indicates either the PFL/AFL bus output level or the input level of the signals sent from the TAPE IN jacks, depending on the setting of the Monitor source select switch in the C-R MONI section.

■ When the switch is set to MATRIX ()

The meter indicates the output level of Matrix 1 and 2.

Meter bridge

This peak level meter indicates the output level of the MIX buses, ST bus, Matrixes 1/2, PFL bus, and AFL bus, and the level of the signal input from the TAPE IN jacks.

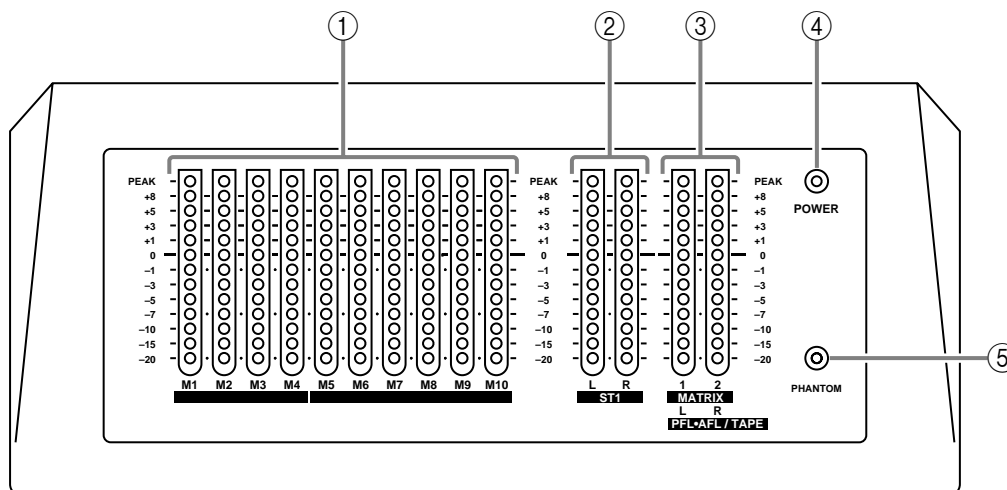

A M1–M10 meters

These meters indicate the output level of MIX OUT 1–10.

B ST1 meters

These meters indicate the output level of ST1 OUT.

C MATRIX (PFL•AFL/TAPE) meters

These meters indicate the PFL/AFL bus level, input level of signals sent from the TAPE IN jacks, or the output level of Matrixes 1/2, depending on the selection made in the METER SELECT section.

D POWER indicator

When the power to the GA32/12 (or GA24/12) is turned on, this indicator lights up.

E PHANTOM indicator

This indicator lights up when any of the phantom power supplies (see page 16, rear panel 4) are turned on.

Rear Panel

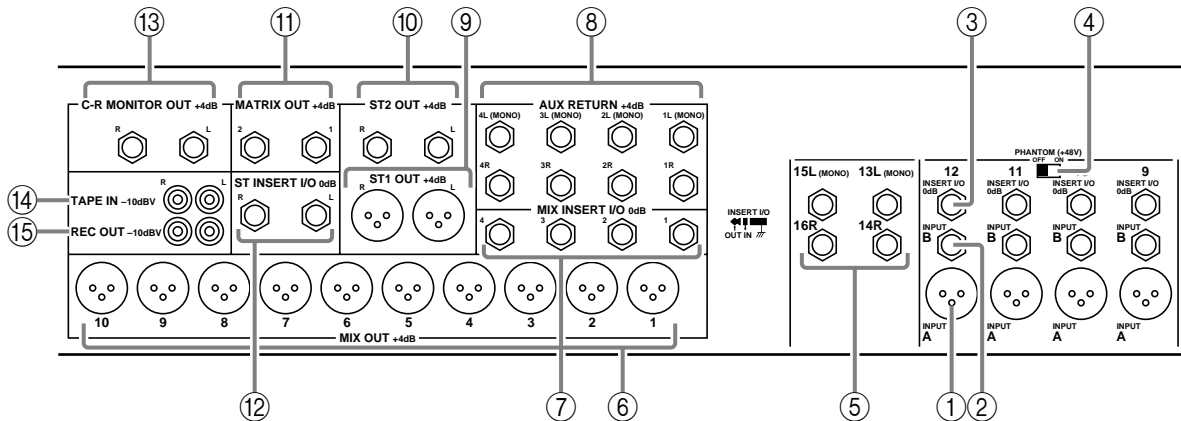

A INPUT A jacks 1-12, 17-32 {1-12, 17-24}

These are balanced, XLR-3-31 monaural input jacks. Usually their nominal input levels range from -16 dB to -60 dB. However, when the pad switches (see page 2, front panel 1) are turned on, the nominal input levels range from $+10$ dB to -34 dB. For every group of four input channels, the INPUT A jacks have phantom power of $+48$ V that can be turned on and off. See the figure on the right for wiring.

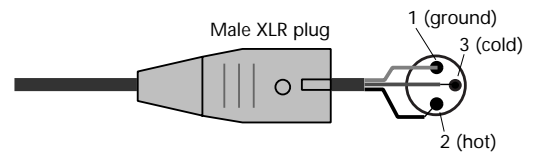

B INPUT B jacks 1-12, 17-32 {1-12, 17-24}

These are balanced TRS phone, monaural input jacks. Their nominal input levels are the same as those for INPUT A . You cannot use the INPUT A jack and INPUT B jack for the same channel simultaneously. Do not connect plugs to both A and B jacks of the same channel at the same time. Otherwise, a malfunction may occur. Phantom power is not available for the INPUT B jacks. See the figure on the right for wiring.

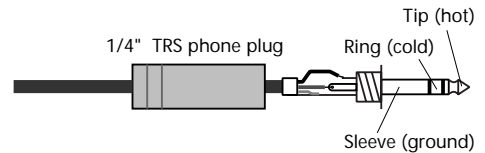

C INSERT I/O jacks 1-12

These TRS phone jacks are used to insert an external processor into monaural input channels 1-12, 17-32 {17-24} with nominal input/output levels of 0 dB. See the figure below for wiring.

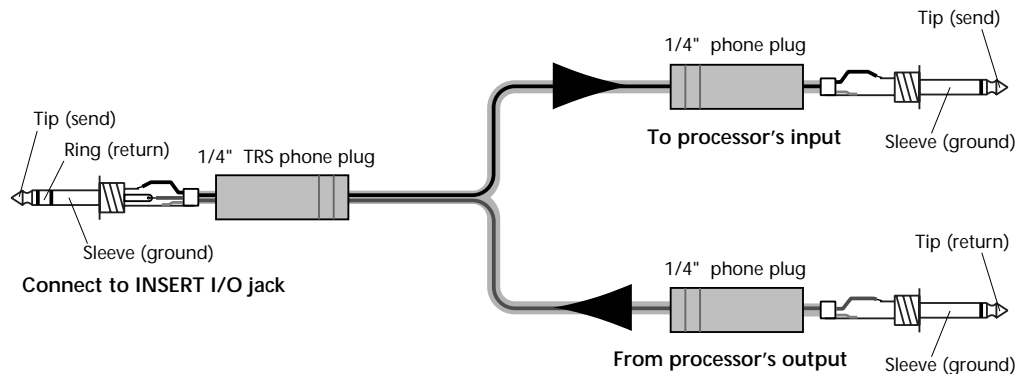

D PHANTOM (+48 V) switches

These switches are used to turn the $+48$ V phantom power on and off for every group of four input channels. If one of these switches is turned on, the PHANTOM indicator on the Meter bridge will light up.

E INPUT jacks 13–16

These are unbalanced phone jacks for the stereo input channels, with nominal input levels ranging from -34 dB to $+10$ dB. If you are using the stereo input modules as monaural channels, connect a plug to 13L (MONO) or 15L (MONO) jack. See the figure on the right for wiring.

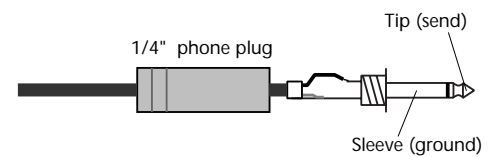
**F MIX OUT 1–10 jacks**

These balanced XLR-3-32 jacks output MIX bus 1–10 signals individually, with a nominal output level of $+4$ dB. See the figure on the right for wiring.

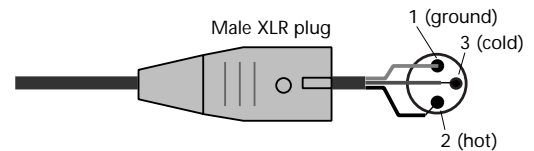
**G MIX INSERT I/O jacks**

These TRS phone jacks are used to insert an external processor into MIX buses 1–4, with nominal input/output levels of 0 dB. See the figure below for wiring.

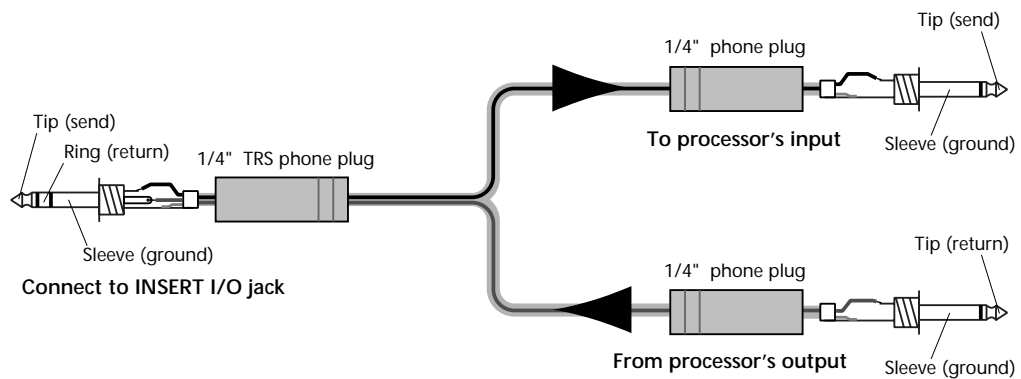
**H AUX RETURN 1–4 jacks**

These unbalanced phone jacks are used to connect stereo outputs from an external effect processor, with nominal input level of $+4$ dB. To input monaural signals, use only the L (MONO) jack. See the figure on the right for wiring.

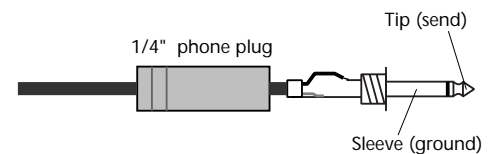
**I ST1 OUT jacks**

These balanced XLR-3-32 jacks output ST bus signals, with a nominal output level of $+4$ dB. See the figure on the right for wiring.

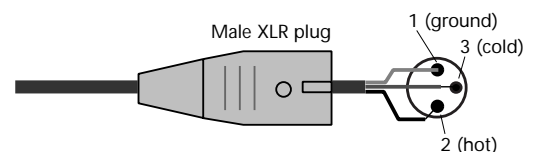
**J ST2 OUT jacks**

These unbalanced phone jacks output ST bus signals, with a nominal output level of $+4$ dB. See the figure on the right for wiring.

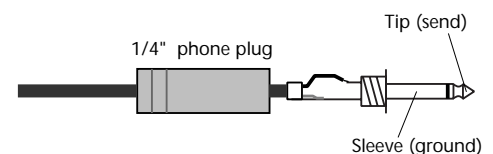
**K MATRIX OUT jacks 1/2**

These unbalanced phone jacks output Matrix 1/2 signals that are a mix of MIX buses 1–4 and ST bus, with a nominal output level of $+4$ dB. See the figure on the right for wiring.

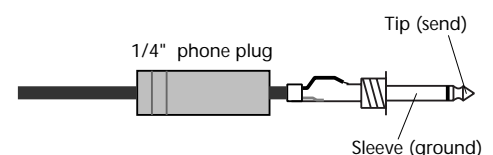

L ST INSERT I/O jacks

These TRS phone jacks are used to insert an external processor into the ST bus, with nominal input/output levels of 0 dB. See the figure below for wiring.

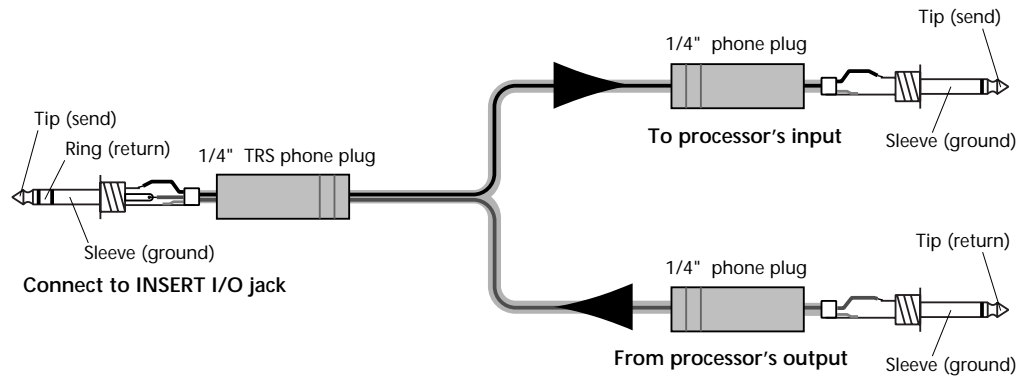

M C-R MONITOR OUT jacks

These unbalanced phone jacks are used to monitor input signals sent from the PFL bus, AFL bus, and TAPE IN jacks, with a nominal output level of +4 dB. See the figure on the right for wiring.

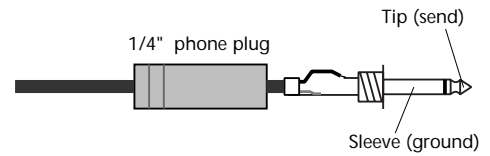

N TAPE IN jacks

These unbalanced phono jacks are used to connect a line-level device, with a nominal input level of -10 dBV. See the figure on the right for wiring.

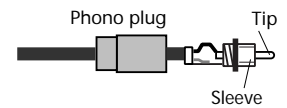

O REC OUT jacks

These unbalanced phono jacks output line-level, pre-fader, pre-insert I/O ST bus signals. See the figure on the right for wiring.

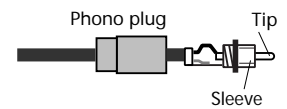

GA Diversity Function

What is GA Diversity?

GA Diversity is an output select function that allows you to use the MIX OUT jacks as group output jacks or AUX output jacks on the GA32/12 and GA24/12.

You can route either MIX (Variable) bus signals or MIX (Fix) bus signals to the MIX OUT 1–4 jacks of the GA32/12 and GA24/12. You can select either one of these output signals in the Variable/Fix select section.



If the M1–M4 switches in the Variable/Fix select section are set to FIX (), the corresponding MIX OUT jacks will output MIX (FIX) bus signals. Since each channel's output level for the MIX (FIX) bus signals is fixed, the corresponding MIX OUT jacks will function as group output jacks.

If the M1–M4 switches in the Variable/Fix select section are set to VARIABLE (), the corresponding MIX OUT jacks will output MIX (VARIABLE) bus signals. Since each channel's output level for the MIX (VARIABLE) bus signals is variable, the corresponding MIX OUT jacks will function as AUX output jacks.

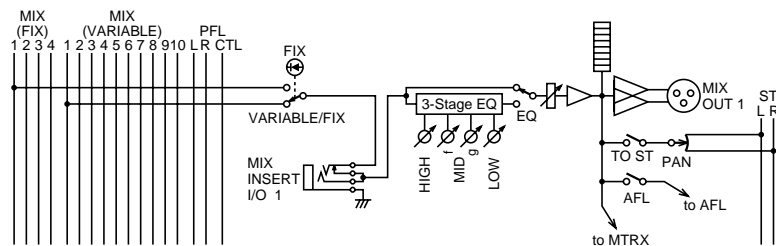
The GA Diversity function will enable you to configure a flexible bus system, such as four groups and six AUX sends, two groups and eight AUX sends, or 10 AUX sends, etc., depending on the application.



Setting the GA Diversity function

1. Press down the M1 switch ( FIX) in the Variable/Fix select section (see page 6).
The FIX indicator will light up. The MIX OUT 1 output channel will receive the MIX (FIX) 1 bus signal, and the MIX OUT 1 jack will function as a group output jack.
2. Press the M1 switch again to set it to ( VARIABLE).
The FIX indicator will be turned off. The MIX OUT 1 output channel will receive the MIX (VARIABLE) 1 bus signal, and the MIX OUT 1 jack will function as an AUX output jack.
3. Set the M2, M3, and M4 switches in the same way.
You can set MIX OUT 1–4 channels to “FIX” or “VARIABLE” individually.

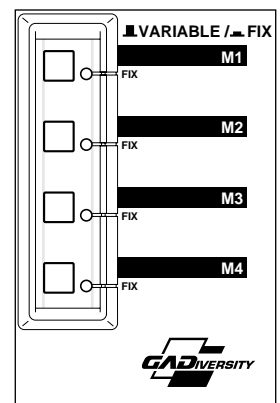

Specifications

General specifications

Frequency response	20 Hz–20 kHz +1 dB, –2 dB, +4 dB 600Ω (ST1 OUT, ST2 OUT, MIX OUT, MATRIX OUT)		
Total harmonic distortion	<0.1% @20 Hz–20 kHz, +14 dB 600Ω (ST1 OUT, ST2 OUT, MIX OUT, MATRIX OUT)		
Hum and noise (Rs=150Ω, 20 Hz–20 kHz)	–128 dB equivalent input noise		
	–95 dB residual output noise (ST1 OUT, ST2 OUT, MIX OUT, MATRIX OUT)		
	–83 dB residual output noise (ST1 OUT)	ST master fader at nominal level. all channel fader, mix level control: minimum ST switch: OFF	
	–78 dB residual output noise (MIX OUT)	Mix master fader at nominal level. all channel fader, mix level control: minimum M1–M4 switch: OFF	
	–64 dB (68 dB S/N) (ST1 OUT, MIX OUT)	ST master/mix master fader, one channel fader and mix level control at nominal level. one channel gain control: maximum	
Maximum voltage gain	84 dB CH IN to ST1 OUT 84 dB CH IN to MIX OUT 58 dB ST IN to ST1 OUT 58 dB ST IN to MIX OUT		
Crosstalk at 1 kHz	–70 dB adjacent input –70 dB input to output		
Gain control	44 dB variable		
Channel input pad	0 dB/26 dB		
Channel input HPF	80 Hz 12 dB/oct		
Input channel equalization	±15 dB Maximum HIGH 10 kHz * shelving HI-MID 400 Hz–8 kHz peaking LO-MID 80 Hz–1.6 kHz peaking LOW 100 Hz * shelving		
ST input channel equalization	±15 dB Maximum HIGH 10 kHz * shelving HI-MID 3 kHz peaking LO-MID 800 Hz peaking LOW 100 Hz * shelving		
Mix out equalization	±15 dB Maximum HIGH 10 kHz * shelving MID 300 Hz–6 kHz peaking LOW 100 Hz * shelving		
Meters	13 points LED x 14		
Channel peak indicators	An indicator for each channel turns on when the pre-channel fader signal is –3 dB below clipping.		
Phantom power	+48V (balanced)		
Power requirement	USA and Canadian General	120 V AC 60 Hz 230 V AC 50 Hz	
Power consumption	120 W		
Dimensions (WxHxD)	GA32/12: 1372 x 161 x 705 mm GA24/12: 1144 x 161 x 705 mm		
Weight	GA32/12: 38 kg GA24/12: 34 kg		

* Turn over/Roll off frequency of shelving: 3 dB below maximum variable level.

Specifications are subject to change without prior notice.

Input specifications

Input connectors	Gain trim	Input impedance	Nominal impedance	Input level			Connector type
				Sensitivity ¹	Nominal level	Max. before clipping	
CH INPUT 1–12, 17–24/32	MAX	3 k Ω	50-600 Ω Mics	–86 dB (38.8 μ V)	–60 dB (775 μ V)	–40 dB (7.75 mV)	A: XLR-3-31 type ² B: Phone jack ²
	MIN			–42 dB (6.16 mV)	–16 dB (123 mV)	+4 dB (1.23 V)	
CH INPUT 13–16	MAX			–60 dB (775 μ V)	–34 dB (15.5 mV)	–14 dB (155 mV)	Phone jack (TRS) ³
	MIN			–16 dB (123 mV)	+10 dB (2.45 V)	+30 dB (24.5 V)	
AUX RETURN				–12 dB (195 mV)	+4 dB (1.23 V)	+20 dB (7.75 V)	
TAPE IN		10 k Ω	600 Ω Line	–26 dBV (50.1mV)	–10 dBV (316 mV)	+8 dBV (2.51 V)	Phono
CH INSERT I/O				–26 dB (38.8 mV)			
ST INSERT I/O				–10 dB (245 mV)	0 dB (775 mV)	+20 dB (7.75 V)	Phone jack, TRS ⁴
MIX INSERT I/O							
TALKBACK INPUT			50-600 Ω Mics	–66 dB (338 μ V)	–50 dB (2.45 mV)	–24 dB (48.9 mV)	XLR-3-31 type ³

- Sensitivity is the lowest level that will produce an output of +4 dB (1.23 V) or the nominal output level when the unit is set to maximum gain.
- Balanced
- Unbalanced
- T: OUT, R: IN, S: GND
 - 0 dB=0.775 Vrms, 0 dBV=1 Vrms

Output specifications

Output connector	Output impedance	Nominal impedance	Output level		Connector type
			Nominal	Max. before clipping	
ST1 OUT	150 Ω			+24 dB (12.3 V)	XLR-3-32 type ¹
ST2 OUT				+20 dB (7.75 V)	Phone jack ²
MIX OUT	75 Ω	600 Ω Lines	+4 dB (1.23 V)	+24 dB (12.3 V)	XLR-3-32 type ¹
MATRIX OUT				+20 dB (7.75 V)	Phone jack ²
C-R MONITOR OUT					
REC OUT			–10 dBV (316 mV)	+10 dBV (3.16 V)	Phono
CH INSERT I/O	600 Ω	10 k Ω Lines	0 dB (775 mV)	+20 dB (7.75 V)	Phone jack, TRS ³
ST INSERT I/O					
MIX INSERT I/O					
PHONES	100 Ω	40 Ω Phones	3 mW	100 mW	ST phone jack

- Balanced
- Unbalanced
- T: OUT, R: IN, S: GND
 - 0 dB=0.775 Vrms, 0 dBV=1 Vrms

Dimensions

GA32/12

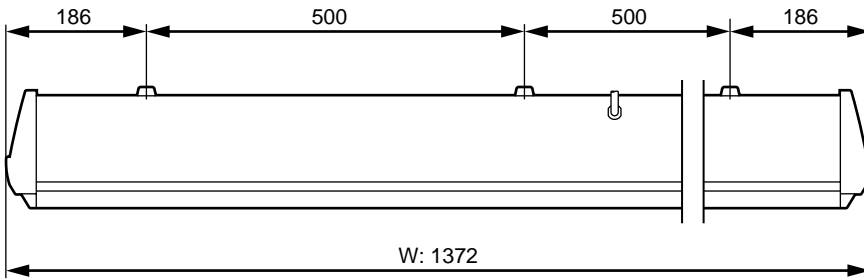

GA24/12

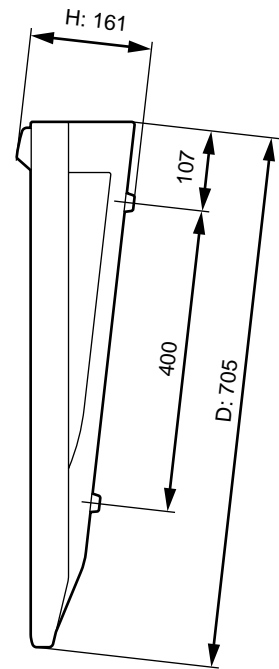
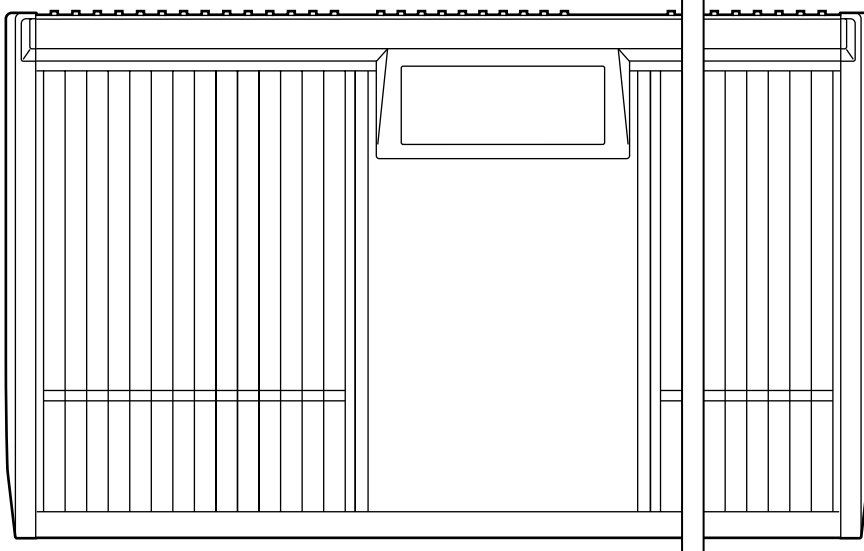
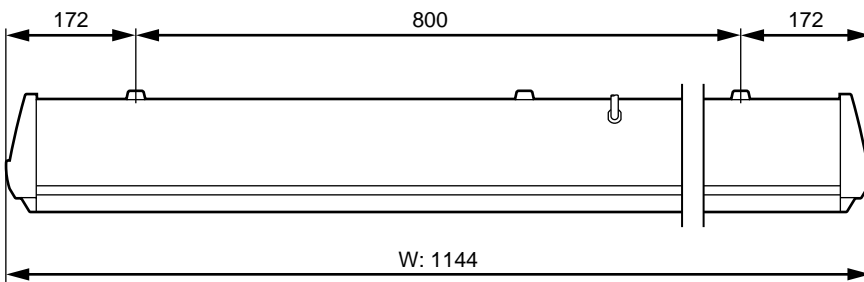

Unit: mm

Block and Level diagram

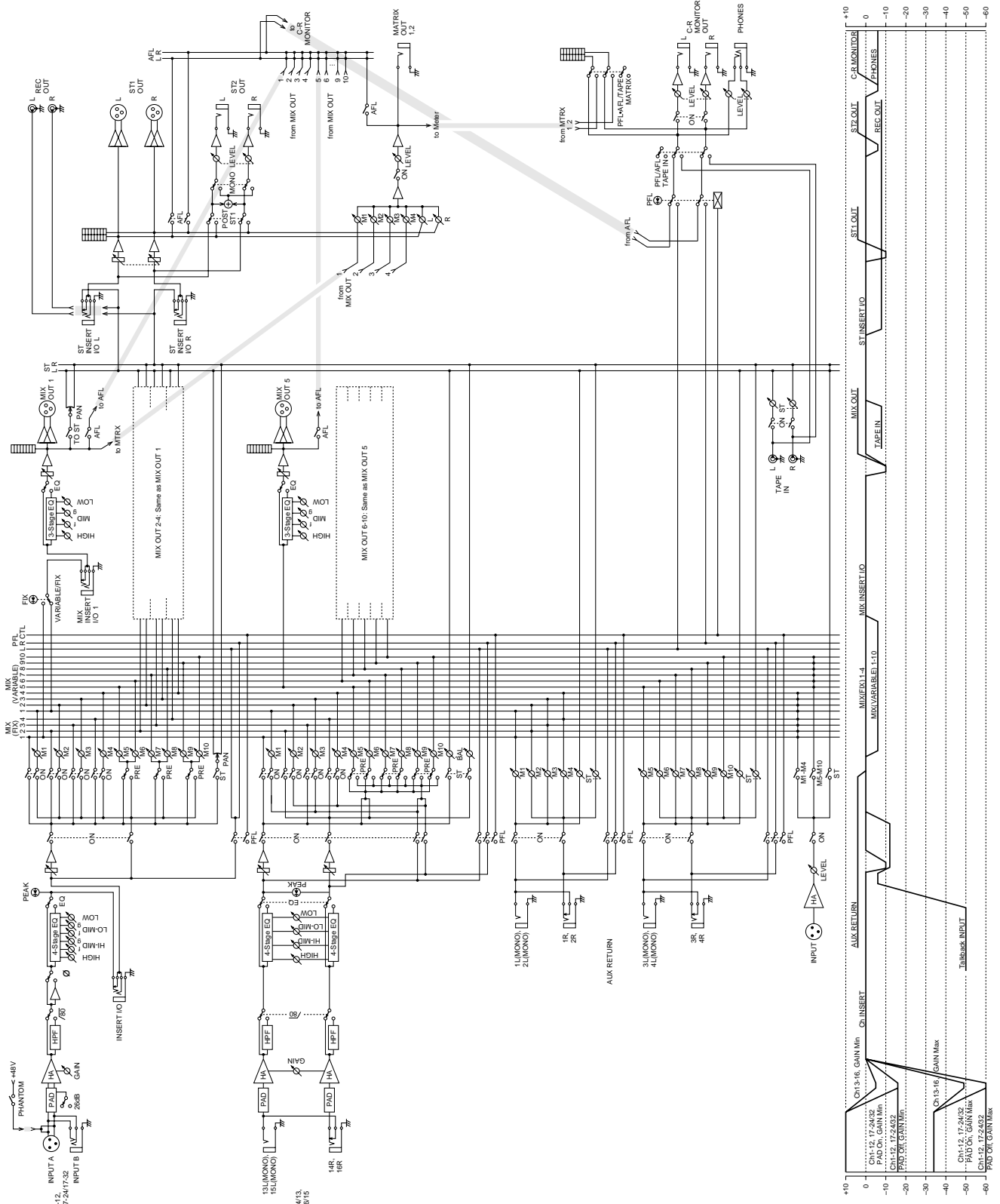

YAMAHA