

PS-5

SUPER Shifter

Owner's Manual

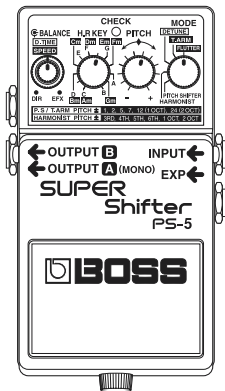

BOSS

Thank you, and congratulations on your choice of BOSS PS-5 Super Shifter.

Before using this unit, carefully read the sections entitled: “USING THE UNIT SAFELY” and “IMPORTANT NOTES” (Owner’s manual page 37–43; page 4–5). These sections provide important information concerning the proper operation of the unit. Additionally, in order to feel assured that you have gained a good grasp of every feature provided by your new unit, Owner’s manual should be read in its entirety. The manual should be saved and kept on hand as a convenient reference.

Copyright © 1999 BOSS CORPORATION

All rights reserved. No part of this publication may be reproduced in any form without the written permission of BOSS CORPORATION.

Features

- The compact Boss PS-5 pitch shifter is equipped with a high-performance 24-bit DSP (digital sound processor) chip, and features numerous functions with high-quality sound.
 - Select from five modes to use - PITCH SHIFTER, HARMONIST, DETUNE, T.ARM, and FLUTTER (new effect).
 - You can get split functions on this one device, with the Pitch Shifter going into effect when chords are played, and Harmonist when playing single notes.
 - You can even use the Harmonist post-distortion effects devices. *1
 - Delay control and stereo outs provide even more effective detuning.
 - Effects simulating guitar arming (T.Arm and Flutter) are included.
 - With an expression pedal (Roland EV-5; sold separately) connected, you can get continuous control of the amount of pitch shift while you play.
- *1 *In HARMONIST mode, the instrument's scale is detected and harmonies are added to the output. Make sure the instrument is tuned correctly in this mode. Errors in tuning will cause the harmonies to be out of tune as well. In addition, tune the instrument by setting the reference pitch A4 to 440 Hz. Monitor post-distortion volume levels with the PS-5 after a distortion effects device in the signal path. Excessive volume levels can cause the harmony tuning to slip.*

IMPORTANT NOTES

In addition to the items listed under “USING THE UNIT SAFELY” on page 37, please read and observe the following:

Power Supply: Use of Batteries

- Do not use this unit on the same power circuit with any device that will generate line noise (such as an electric motor or variable lighting system).
- The AC adaptor will begin to generate heat after long hours of consecutive use. This is normal, and is not a cause for concern.
- The use of an AC adaptor is recommended as the unit's power consumption is relatively high. Should you prefer to use batteries, please use the alkaline type.
- Batteries should always be installed or replaced before connecting any other devices. This way, you can prevent malfunction and/

or damage to speakers or other devices.

- A battery is supplied with the unit. The life of this battery may be limited, however, since its primary purpose was to enable testing.
- Before connecting this unit to other devices, turn off the power to all units. This will help prevent malfunctions and/or damage to speakers or other devices.

Placement

- Using the unit near power amplifiers (or other equipment containing large power transformers) may induce hum. To alleviate the problem, change the orientation of this unit; or move it farther away from the source of interference.
- This device may interfere with radio and television reception. Do not use this device in the vicinity of such receivers.

- Do not expose the unit to direct sunlight, place it near devices that radiate heat, leave it inside an enclosed vehicle, or otherwise subject it to temperature extremes. Excessive heat can deform or discolor the unit.
- To avoid possible breakdown, do not use the unit in a wet area, such as an area exposed to rain or other moisture.

Maintenance

- For everyday cleaning wipe the unit with a soft, dry cloth or one that has been slightly dampened with water. To remove stubborn dirt, use a cloth impregnated with a mild, non-abrasive detergent. Afterwards, be sure to wipe the unit thoroughly with a soft, dry cloth.
- Never use benzine, thinners, alcohol or solvents of any kind, to avoid the possibility of discoloration and/or deformation.

Additional Precautions

- Use a reasonable amount of care when using the unit's buttons, sliders, or other controls; and when using its jacks and connectors. Rough handling can lead to malfunctions.
- When connecting / disconnecting all cables, grasp the connector itself-never pull on the cable. This way you will avoid causing shorts, or damage to the cable's internal elements.
- To avoid disturbing your neighbors, try to keep the unit's volume at reasonable levels. You may prefer to use headphones, so you do not need to be concerned about those around you (especially when it is late at night).
- When you need to transport the unit, package it in the box (including padding) that it came in, if possible. Otherwise, you will need to use equivalent packaging materials.
- Use only the specified expression pedal (EV-5; sold separately). By connecting any other expression pedals, you risk causing malfunction and/or damage to the unit.

Panel Description

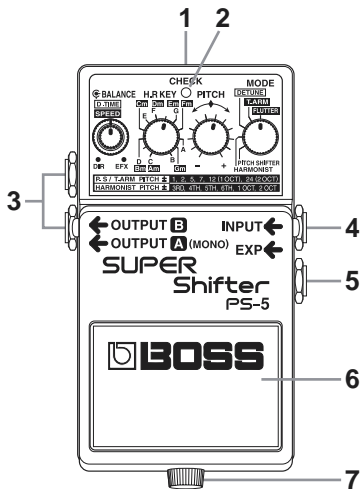

1. AC adaptor jack

An AC adaptor (BOSS PSA-series: sold separately) can be connected to this jack. If an AC adaptor is used, you will be able to play for extended periods without worrying about battery life.

** As soon as you connect the AC adaptor, the unit is turned on.*

** If there is the battery in the unit while an AC adaptor is being used, normal operation will continue should the line voltage be interrupted (power blackout or power cord disconnection).*

2. CHECK indicator

This indicator shows whether an effect is on/off, and also doubles as the Battery Check indicator.

The indicator lights when an effect is on. If this indicator goes dim or no longer lights while an effect is on, the battery is near exhaustion and should be replaced immediately. For the procedure, refer to “Changing the battery” (page 28).

3. OUTPUT jacks A(MONO)/B

These output jacks are connected to an amplifier or other effects device. The sound is output at the volume set with the BALANCE knob.

** The output varies with the MODE switch setting. For more detailed information, refer to “Description of Each Mode” (p. 14–25).*

4. INPUT jack

This jack accepts input signals (coming from a guitar, some other musical instrument, or another effects unit).

** When a battery is used, the INPUT jack also functions as a power switch. When a plug is inserted into the INPUT jack, the power will be turned on. When the plug is pulled out, the power will be turned off. When you are not using the unit, pull the plug out of the INPUT jack.*

5. EXP jack

Connect an expression pedal (Roland EV-5; sold separately) here. Depressing the pedal changes the amount of pitch shift. For more detailed information, refer to “Description of Each Mode” (page 14–25).

6. Pedal switch

Pressing this switch will turn the effect on/off.

7. Thumbscrew

When this screw is loosened, the pedal will open, allowing you to change the battery. For the procedure, refer to “Changing the battery” (page 28).

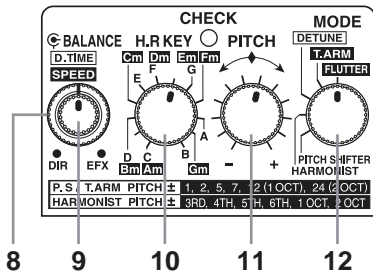

8. D.TIME/SPEED knob

* *This is not effective in PITCH SHIFTER/HARMONIST mode.*

In T.ARM / FLUTTER modes:

This adjusts the speed of the pitch change. The more the button is rotated to the right, the faster the shift rate.

In DETUNE mode:

This adjusts the delay time. The delay time is increased as the knob is rotated to the right.

9. BALANCE knob

This adjusts the output balance between the direct sound and the effect sound.

In PITCH SHIFTER / HARMONIST / DETUNE modes:

With the BALANCE knob set at the center position, the direct sound and effects sound are output equally (1:1). When the knob is rotated completely to the left, only direct sound is output; when the knob is turned all the way to the right, only the effect sound is output.

In T.ARM / FLUTTER modes:

This adjusts the volume of the output sound.

No effect sound is output when the knob is turned completely to the left; with the knob all the way to the right, the sound is boosted by 6 dB.

10. H.R KEY switch

This selects the key for performing in HARMONIST mode.

This determines the harmonic scales used for each scale input from the song's key and intervals (position of the PITCH switch setting). For more detailed information, refer to "Key setting" (page 18).

** The proper harmony intervals will not be output if the song is played in the wrong key.*

11. PITCH switch

In PITCH SHIFTER / DETUNE / T.ARM / FLUTTER modes:

This sets the degree of pitch shift. For more details, refer to “Description of Each Mode” (page 14–25).

In HARMONIST mode:

This sets the interval. For more details, refer to “Description of Each Mode” (page 16–19). For more on the harmonic scales output based on the H.R KEY switch and the PITCH switch (interval) settings, refer to “About the scale of the effect sound” (page 19).

12. MODE switch

This is used for selecting the PITCH SHIFTER, HARMONIST, DETUNE, T.ARM, and FLUTTER modes. For more on the functions for the knobs in each mode, refer to “Description of Each Mode” (page 14–25).

Connections

● Making the Basic Connections

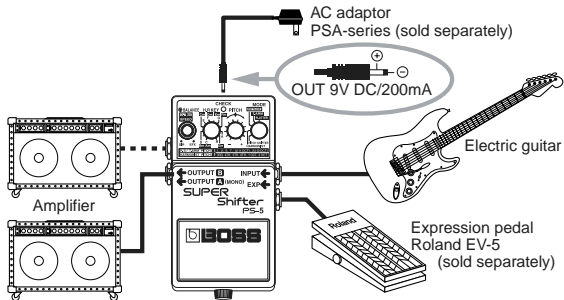

- * Use only the specified expression pedal (Roland EV-5; sold separately). By connecting any other expression pedals, you risk causing malfunction and/or damage to the unit.
- * When using the PS-5 for monaural sound, connect the OUTPUT A jack to your guitar amplifier.
- * Inserting a plug into the Input Jack will automatically switch the unit on.

- * Before connecting or disconnecting any patch cords, be sure all the volume controls in your system are set to minimum. This will help prevent any damage to system components.
- * To prevent malfunction and/or damage to speakers or other devices, always turn down the volume, and turn off the power on all devices before making any connections.
- * Always make sure to have the volume level turned down before switching on power. Even with the volume all the way down, you may still hear some sound when the power is switched on, but this is normal, and does not indicate a malfunction.

● Connecting OverDrive or Distortion Effects

This allows you to get a clean distortion sound like that when twin guitars are used.

* *If you are using a compressor, have the device connected after the guitar.*

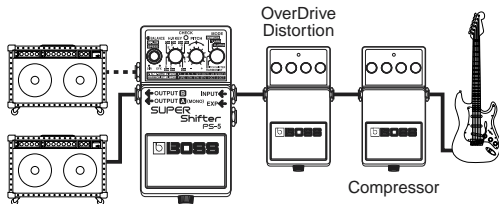

● Connecting Spatial Effects Devices

Spatial effects are applied to the entire output of the PS-5.

When using the PS-5 in PITCH SHIFTER / HARMONIST / DETUNE mode:

Spatial effects are applied only to the direct sound (the sound that is not pitch shifted).

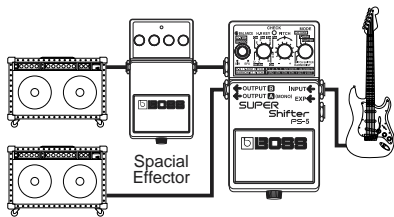
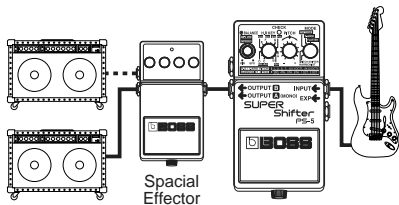

Description of Each Mode

PITCH SHIFTER

The pitch of the output sound can be shifted up or down a maximum of two octaves.

* *This can be used both for single notes and chords.*

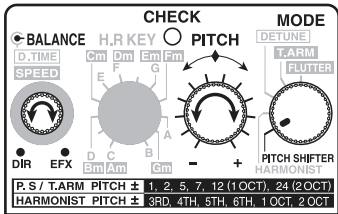

1. After making the necessary connections (page 11), press the pedal switch to turn the effect on (the CHECK indicator should be lit).
2. Rotate the PITCH switch to select the desired degree of pitch shift.

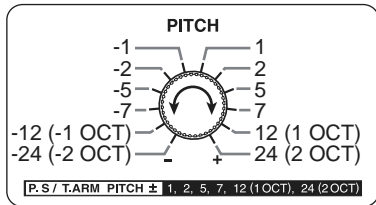

3. Rotate the BALANCE knob to adjust the balance between the effect and direct sounds.

** When the stereo outs are used, the balance of the sound output corresponds to the BALANCE knob setting, with effects sound output from OUTPUT A and direct sound from OUTPUT B.*

4. Connecting the optional Roland EV-5 to the EXP jack provides continuous changes in pitch, up to the amount set with the PITCH switch in Step 2.

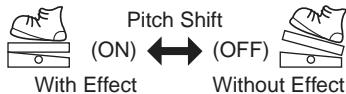

HARMONIST

Use only for single notes, not chords.
This takes the input sound, creates harmonies up to two octaves above or below, and outputs the sounds together.

- * *Monitor volume levels in this mode when the PS-5 is connected following heavy equalization or distortion effects. Harmonies may become shifted at excessive volume levels.*
- * *Using a tuner such as the optional TU-12 or TU-2 to make sure your instruments are properly tuned. Tune after setting the reference pitch A4 to 440 Hz.*

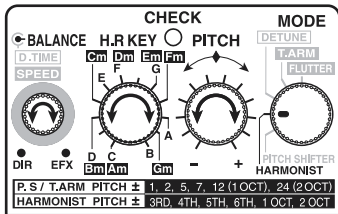

1. After making the necessary connections (page 11), press the pedal switch to turn the effect on (the CHECK indicator should be lit).
2. Use the H.R KEY switch to select the same key as that of the song to be performed. For more detailed information, refer to “Key setting” (page 18).

3. Rotate the PITCH switch to select the desired interval.

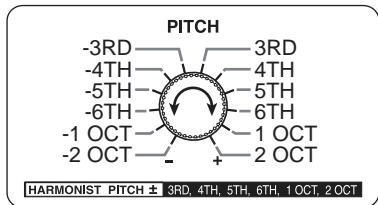

For more on the harmony output based on the H.R KEY switch and the PITCH switch (interval) settings, refer to “About the scale of the effect sound” (page 19).

4. Rotate the BALANCE knob to adjust the balance between the effect and direct sounds.

** When the stereo outs are used, the balance of the sound output corresponds to the BALANCE knob setting, with effects sound output from OUTPUT A and direct sound from OUTPUT B.*

5. Connecting the optional Roland EV-5 to the EXP jack provides continuous changes in pitch, up to the amount set with the PITCH switch in Step 3.

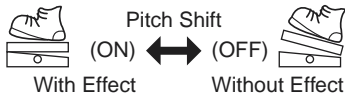

Key setting

The Key setting you should choose for the music you play will vary as shown below depending on the key signature (\sharp , \flat) in the music score.

Major C F B \flat E \flat A \flat D \flat G \flat

Minor Am Dm Gm Cm Fm B \flat m E \flat m

Major G D A E B F \sharp

Minor Em Bm F \sharp m C \sharp m G \sharp m D \sharp m

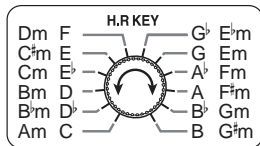

About the scale of the effect sound

The PS-5 creates its harmony parts based upon the key of the song selected and the unit's other panel settings. The keys that can be set on the PS-5 are majors and minors of all the scales. For example, if you select "C(Am)", the resulting harmony will be as shown below:

UP

+5 (-4)	G	G	A	A	B	C	C	D	D	E	E	F
+3 (-6)	E	E	F	F [#]	G	A	A	B	B	C	C [#]	D
INPUT	C	C[#]	D	D[#]	E	F	F[#]	G	G[#]	A	A[#]	B
-3 (+6)	A	A [#]	B	B	C	D	D	E	E	F	F [#]	G
-5 (+4)	F	F [#]	G	G [#]	A	B	B	C	C [#]	D	D [#]	E

DOWN

+5 (-4)	G	F	F	E	D	D	C	C	B	A [#]	A	G [#]
+3 (-6)	E	D	C [#]	C	B	B	A	A	G	F [#]	F	F
INPUT	C	B	A[#]	A	G[#]	G	F[#]	F	E	D[#]	D	C[#]
-3 (+6)	A	G	G	F	E	E	D	D	C	C	B	A [#]
-5 (+4)	F	E	E	D	C [#]	C	B	B	A	A	G	G

DETUNE

This adds a subtle pitch shift to the input sound, producing a detuned effect.

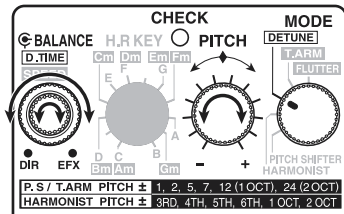

1. After completing the necessary connections (page 11), press the pedal switch to turn the effect on (the CHECK indicator should be lit).
2. Rotate the PITCH switch to select the desired degree of shift.

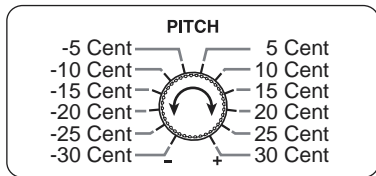

3. Rotate the D.TIME knob to adjust the delay time.

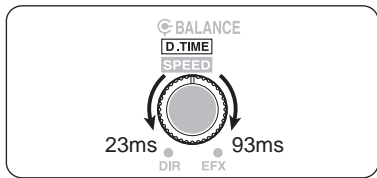

4. Rotate the BALANCE knob to adjust the balance between the effect and direct sounds.

* *When the stereo outs are used, the effects sound is output from OUTPUT A and the direct sound from OUTPUT B, with the balance of the sound determined by the BALANCE knob setting.*

5. Connecting the optional Roland EV-5 to the EXP jack provides continuous changes in pitch, up to the amount set with the PITCH switch in Step 2.

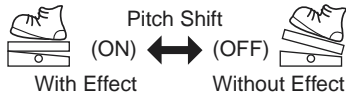

T.ARM

Use only for single notes, not chords.

This gives you an effect simulating the change in sound with a guitar tremolo arm. The T.ARM effect is applied as long as the pedal switch is depressed.

* *When the pedal switch is released, the pitch returns the sound to the normal unchanged pitch.*

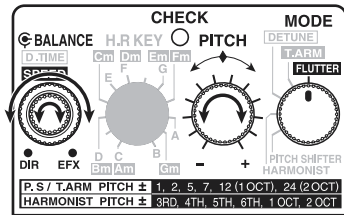

1. Connect the PS-5 to another instrument (page 11).
2. Rotate the PITCH switch to select the desired degree of shift.

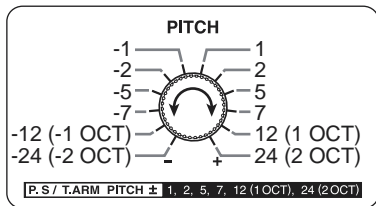

Play the guitar with the pedal switch in the forward position, adjusting the effect while you listen to the sound.

3. Rotate the SPEED knob to adjust the period used to reach the shift set in Step 2.

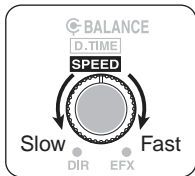

Play the guitar while switching the pedal switch on and off, adjusting the effect while you listen to the sound.

4. Use the BALANCE knob to adjust the volume of the output sound.

* *The same sound is output from both*

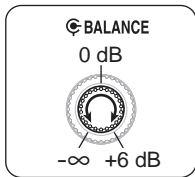

OUTPUT A(MONO) and OUTPUT B.

* *Sounds input at 0 dB are output at the same volume.*

5. With a Roland EV-5 (sold separately) connected to the EXP jack, you can use the pedal for smooth, continuous adjustment of the degree of shift, within the range set with the PITCH switch in Step 2.

* *The degree of shift adjusted with the EV-5 is determined by the point at which the PS-5's pedal switch is turned on.*

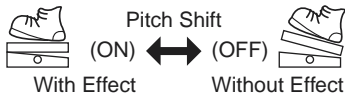

FLUTTER

This simulates the sound of the tremolo arm effect used in rock music.

The FLUTTER effect is applied as long as the pedal switch is depressed.

* When the pedal switch is released, the pitch returns the sound to the normal unchanged pitch.

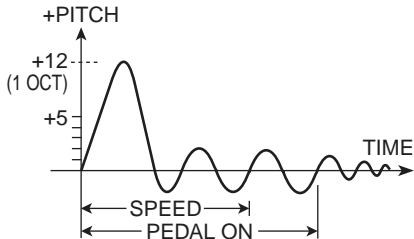
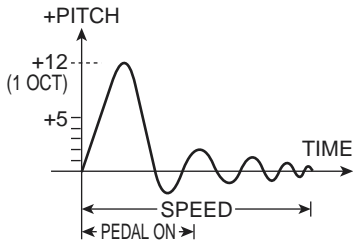
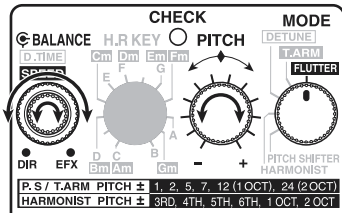

1. Connect the PS-5 to another instrument (page 11).
2. Rotate the PITCH switch to select the desired degree of shift.

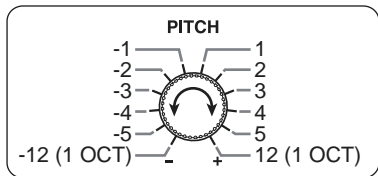

3. Rotate the SPEED knob to adjust the period used to reach the shift and the delay.
4. Repeat Steps 2 and 3 until the sound is adjusted to your liking.
5. Use the BALANCE knob to adjust the volume of the output sound.

- * *The same sound is output from both OUTPUT A (MONO) and OUTPUT B.*
- * *Sounds input at 0 dB are output at the same volume.*

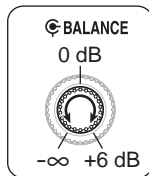

6. With a Roland EV-5 (sold separately) connected to the EXP jack, you can use the pedal for smooth, continuous adjustment of the degree of shift, within the range set with the PITCH switch in Step 2.
- * *The degree of shift adjusted with the EV-5 is determined by the point at which the PS-5's pedal switch is turned on.*

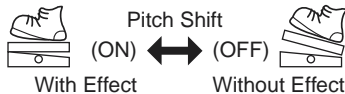

Using the EXP jack

Connecting an expression pedal (Roland EV-5; sold separately) allows you to use pedal action for continuous control of the pitch shift.

1. Referring to “Connections” (page 11–13), connect the PS-5 to another instrument.
2. Set the EV-5’s minimum volume to the lowest value (0) on the PS-5.
** Failure to set the minimum volume properly will alter the degree of pitch shift, which can cause the PS-5 to function improperly.*

3. Press the pedal switch to the forward position; then set the degree of pitch shift with the PITCH switch.



** The degree of shift adjusted with the PITCH switch differs depending on the MODE switch setting. Refer to “Description of Each Mode” (page 14–25).*

4. When the EV-5 is returned to the original position, the sound is output with no change in pitch.



In PITCH SHIFTER/HARMONIST modes, use the EV-5 to change the pitch while you perform.



In DETUNE/T.ARM/FLUTTER modes, the pedal is convenient for changing pitch settings.

Using the Mode Label

The PS-5 comes with a Mode Label which shows the effect obtained with each of the modes. The Label (which serves as a quick reference) can be attached as shown in the illustration.

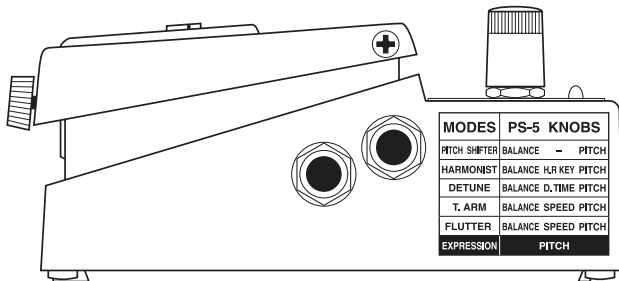

Changing the battery

When the CHECK indicator goes dim or no longer lights while an effect is on, it means that the battery is nearly dead and must be replaced. Replace the battery following the steps below.

* *For best results (i.e., longest usable life) use an alkaline type battery.*

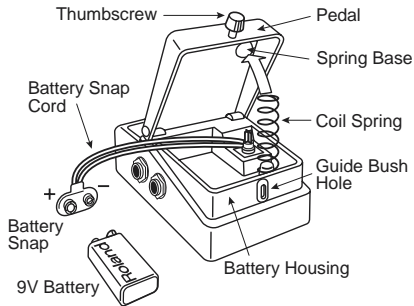

1. Loosen the thumbscrew at the front of the pedal, then lift the pedal upwards to open the unit.

* *The thumbscrew can be left in the pedal while changing the battery.*

2. Remove the old battery from the battery housing, and remove the battery snap connected to it.

3. Connect the battery snap to the new battery, and place the battery inside the battery housing.

* *Be sure to carefully observe the battery's polarity (+ versus -).*

4. Slip the coil spring onto the spring base on the back of the pedal, then close the pedal.

* *Carefully avoid getting the snap cord caught in the coil spring.*

5. Finally, insert the thumbscrew into the guide bush hole and fasten it securely.

Troubleshooting

Power does not come on:

- **Is the specified adaptor (PSA-series; sold separately) properly connected?**

Check the connection once more (page 11).

- **Is the battery low or dead?**

Replace with a new battery (page 28).

- **Is the guitar connected properly to the INPUT jack?**

Check the connection once more (page 11).

** To prevent excess battery drainage, turn the power on without the plug inserted in the INPUT jack.*

No sound / Low volume:

- **Is the PS-5 properly connected to your instrument?**

Check the connection once more (page 11).

- **Is the volume turned down on any guitar amp or effects device you have connected?**

- **Is the PS-5's BALANCE knob setting correct?**

Check the settings for each mode once more (page 14–25).

** When using stereo output in PITCH SHIFTER, HARMONIST, or DETUNE mode, no effect sound is output with the BALANCE knob turned to DIR, and no direct sound is output with the BALANCE knob turned to EFX.*

* *Regardless of the pedal switch's on/off position, no sound is output when the BALANCE knob is turned to DIR in T.ARM/FLUTTER mode.*

Sound is distorted: Can't get harmonies or pitches:

● **Is the battery low?**

As the battery is drained, the CHECK indicator dims, and the PS-5 may start to function incorrectly. Replace with a new battery (page 28).

● **Is the instrument tuned correctly?**

Make sure to tune your instrument properly. If the instrument is out of tune, it may cause a slip in the harmony's tuning as well. In addition, be sure to set the reference pitch A4 to 440 Hz.

● **Is the sound being input at excessive volume.**

Monitor post-distortion volume levels when the PS-5 is connected after a distortion effects device in the signal path. Excessive volume levels can cause slippage in the harmony's tuning.

● **Is the EV-5's pedal volume turned all the way down?**

● **Is the EV-5's minimum volume set to the lowest value (0)?**

● **Is the H.R KEY switch set to the key of the song being performed?**

Setting samples

PITCH SHIFTER

12-string guitar sound with clean tone

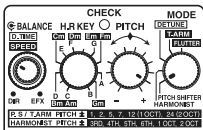

Provides powerful low sound to distortion

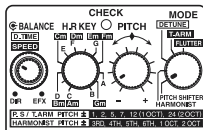

Simulated lowered half-step tuning

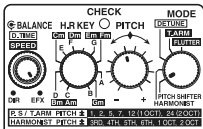

Add harmony regardless of key or scale

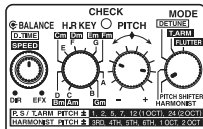

HARMONIST (Use only for single notes, not chords)

Sound with standard harmony added (Major)

Sound like bass

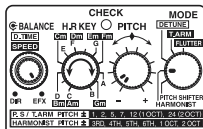
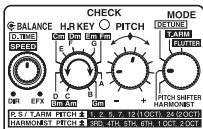

Sound with standard harmony added (Minor)

Sound for the solo playing with a single notes

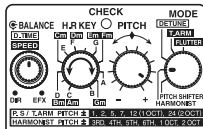
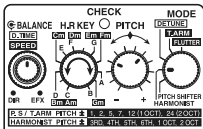

DETUNE

Detuned sound

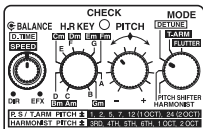

T.ARM

Arm up

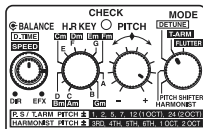

Detuned sound with delay

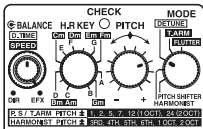

Arm down

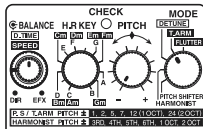

(Perfect for muting with the clean tone)

FLUTTER

Hawaiian

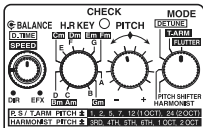

Simulated quick up and down movement on tremolo bar (Simulated cricket)

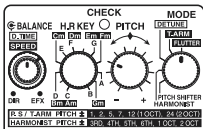

PEDAL PITCH SHIFTER

Pedal pitch shifter for great riff chords and other sounds

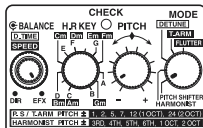

* Connect the Roland EV-5 (optional) to the EXP jack.

Pedal pitch shifter - perfect for solos, leads, and other riffs and licks

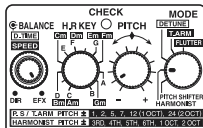

* Connect the Roland EV-5 (optional) to the EXP jack.

Specifications

PS-5: SUPER Shifter

AD Conversion.....	24 bit $\Delta \Sigma$ Method AF Method
DA Conversion.....	20 bit $\Delta \Sigma$ Method
Sample Rate.....	44.1 kHz
Nominal Input Level	-20 dBu
Input Impedance	1 M Ω
Nominal Output Level	-20 dBu
Output Impedance	1 k Ω
Recommended Load Impedance	10 k Ω or greater
Dynamic Range	115 dBu or greater (Direct) 98 dBu or greater (Effect) <i>* 0 dBu = 0.775 Vrms</i>
Controls	Pedal switch, BALANCE knob, D.TIME/SPEED knob, H.R KEY switch, PITCH switch, MODE switch (PITCH SHIFTER, HARMONIST, DETUNE, T.ARM, FLUTTER)
Indicators.....	CHECK indicator (Serves also as battery check indicator)



Connectors	INPUT jack, OUTPUT jacks A (MONO)/B, EXP jack, AC adaptor jack
Power Supply	DC 9 V; Dry Battery 9 V type (6AM6/9 V), AC Adaptor (PSA-series: optional)
Current Draw.....	50 mA (max.) <i>* Expected battery life under continuous use: Alkaline: 6 hours</i> <i>These figures will vary depending on the actual conditions of use.</i>
Dimensions	73 (W) x 129 (D) x 59 (H) mm 2-7/8 (W) x 5-1/8 (D) x 2-3/8 (H) inches
Weight.....	420 g /15 oz (including Battery)
Accessories	Owner's Manual, Mode Label, Dry Battery (6AM6/9 V), Roland Service
Options	AC Adaptor (PSA-series), Expression pedal (Roland EV-5), Dry Battery (6AM6/9 V)

** In the interest of product improvement, the specifications and/or appearance of this unit are subject to change without prior notice.*







USING THE UNIT SAFELY

INSTRUCTIONS FOR THE PREVENTION OF FIRE, ELECTRIC SHOCK, OR INJURY TO PERSONS

About  WARNING and  CAUTION Notices

 WARNING	Used for instructions intended to alert the user to the risk of death or severe injury should the unit be used improperly.
 CAUTION	Used for instructions intended to alert the user to the risk of injury or material damage should the unit be used improperly. * Material damage refers to damage or other adverse effects caused with respect to the home and all its furnishings, as well to domestic animals or pets.

About the Symbols

	The  symbol alerts the user to important instructions or warnings. The specific meaning of the symbol is determined by the design contained within the triangle. In the case of the symbol at left, it is used for general cautions, warnings, or alerts to danger.
	The  symbol alerts the user to items that must never be carried out (are forbidden). The specific thing that must not be done is indicated by the design contained within the circle. In the case of the symbol at left, it means that the unit must never be disassembled.
	The  symbol alerts the user to things that must be carried out. The specific thing that must be done is indicated by the design contained within the circle. In the case of the symbol at left, it means that the power-cord plug must be unplugged from the outlet.

----- **ALWAYS OBSERVE THE FOLLOWING** -----

 **WARNING**

- Before using this unit, make sure to read the instructions below, and the Owner's Manual.



-
- Do not open (or modify in any way) the unit or its AC adaptor.



-
- Do not attempt to repair the unit, or replace parts within it (except when this manual provides specific instructions directing you to do so). Refer all servicing to your retailer, the nearest Roland Service Center, or an authorized Roland distributor, as listed on the "Information" page.
-



 **WARNING**

- Never use or store the unit in places that are:



- Subject to temperature extremes (e.g., direct sunlight in an enclosed vehicle, near a heating duct, on top of heat-generating equipment); or are



- Damp (e.g., baths, washrooms, on wet floors); or are
 - Humid; or are
 - Exposed to rain; or are
 - Dusty; or are
 - Subject to high levels of vibration.
-

- Make sure you always have the unit placed so it is level and sure to remain stable. Never place it on stands that could wobble, or on inclined surfaces.
-



 **WARNING**

- Use only the specified AC adaptor (PSA-series), and make sure the line voltage at the installation matches the input voltage specified on the AC adaptor's body. Other AC adaptors may use a different polarity, or be designed for a different voltage, so their use could result in damage, malfunction, or electric shock.



-
- Avoid damaging the power cord. Do not bend it excessively, step on it, place heavy objects on it, etc. A damaged cord can easily become a shock or fire hazard. Never use a power cord after it has been damaged.
-



 **WARNING**

- This unit, either alone or in combination with an amplifier and headphones or speakers, may be capable of producing sound levels that could cause permanent hearing loss. Do not operate for a long period of time at a high volume level, or at a level that is uncomfortable. If you experience any hearing loss or ringing in the ears, you should immediately stop using the unit, and consult an audiologist.



-
- Do not allow any objects (e.g., flammable material, coins, pins); or liquids of any kind (water, soft drinks, etc.) to penetrate the unit.
-



 **WARNING**

- Immediately turn the power off, remove the AC adaptor from the outlet, and request servicing by your retailer, the nearest Roland Service Center, or an authorized Roland distributor, as listed on the “Information” page when:
 - The AC adaptor or the power-supply cord has been damaged; or
 - Objects have fallen into, or liquid has been spilled onto the unit; or
 - The unit has been exposed to rain (or otherwise has become wet); or
 - The unit does not appear to operate normally or exhibits a marked change in performance.
-





 **WARNING**



- In households with small children, an adult should provide supervision until the child is capable of following all the rules essential for the safe operation of the unit.
.....
 - Protect the unit from strong impact. (Do not drop it!)
-



 **WARNING**

- Do not force the unit's power-supply cord to share an outlet with an unreasonable number of other devices. Be especially careful when using extension cords—the total power used by all devices you have connected to the extension cord's outlet must never exceed the power rating (watts/amperes) for the extension cord. Excessive loads can cause the insulation on the cord to heat up and eventually melt through. 
-
- Before using the unit in a foreign country, consult with your retailer, the nearest Roland Service Center, or an authorized Roland distributor, as listed on the "Information" page. 
-

 **WARNING**

- Batteries must never be recharged, heated, taken apart, or thrown into fire or water. 

-

 **CAUTION**

- The unit and the AC adaptor should be located so their location or position does not interfere with their proper ventilation.



-
- Always grasp only the plug or the body of the AC adaptor when plugging into, or unplugging from, an outlet or this unit.



-
- Whenever the unit is to remain unused for an extended period of time, disconnect the AC adaptor.



-
- Try to prevent cords and cables from becoming entangled. Also, all cords and cables should be placed so they are out of the reach of children.



 **CAUTION**

- Never climb on top of, nor place heavy objects on the unit.



-
- Never handle the AC adaptor body, or its plugs, with wet hands when plugging into, or unplugging from, an outlet or this unit.



-
- Before moving the unit, disconnect the AC adaptor and all cords coming from external devices.



-
- Before cleaning the unit, turn off the power and unplug the AC adaptor from the outlet (p. 6).



 **CAUTION**

- Whenever you suspect the possibility of lightning in your area, disconnect the AC adaptor from the outlet.



-
- If used improperly, batteries may explode or leak and cause damage or injury. In the interest of safety, please read and observe the following precautions (p. 28).
 - Carefully follow the installation instructions for batteries, and make sure you observe the correct polarity.
 - Remove the batteries whenever the unit is to remain unused for an extended period of time.



 **CAUTION**

- If a battery has leaked, use a soft piece of cloth or paper towel to wipe all remnants of the discharge from the battery compartment. Then install new batteries. To avoid inflammation of the skin, make sure that none of the battery discharge gets onto your hands or skin. Exercise the utmost caution so that none of the discharge gets near your eyes. Immediately rinse the affected area with running water if any of the discharge has entered the eyes.
 - Never keep batteries together with metallic objects such as ballpoint pens, necklaces, hairpins, etc.
-
- Used batteries must be disposed of in compliance with whatever regulations for their safe disposal that may be observed in the region in which you live.





For EU Countries

This product complies with the requirements of European Directive 89/336/EEC.

For the USA

FEDERAL COMMUNICATIONS COMMISSION RADIO FREQUENCY INTERFERENCE STATEMENT

This equipment has been tested and found to comply with the limits for a Class B digital device, pursuant to Part 15 of the FCC Rules. These limits are designed to provide reasonable protection against harmful interference in a residential installation. This equipment generates, uses, and can radiate radio frequency energy and, if not installed and used in accordance with the instructions, may cause harmful interference to radio communications. However, there is no guarantee that interference will not occur in a particular installation. If this equipment does cause harmful interference to radio or television reception, which can be determined by turning the equipment off and on, the user is encouraged to try to correct the interference by one or more of the following measures:

- Reorient or relocate the receiving antenna.
- Increase the separation between the equipment and receiver.
- Connect the equipment into an outlet on a circuit different from that to which the receiver is connected.
- Consult the dealer or an experienced radio/TV technician for help.

Unauthorized changes or modification to this system can void the users authority to operate this equipment.
This equipment requires shielded interface cables in order to meet FCC class B Limit.

For Canada

NOTICE

This Class B digital apparatus meets all requirements of the Canadian Interference-Causing Equipment Regulations.

AVIS

Cet appareil numérique de la classe B respecte toutes les exigences du Règlement sur le matériel brouilleur du Canada.

G6017280