

# AKAI

professional

# MB76

## PROGRAMMABLE MIX BAY



The colours of the wires in the main lead of this appliance may not correspond with the colour markings indicating the terminals in this product as follows: the wire which is coloured blue must be connected to the terminal which is marked with the letter 'N' or 'Neutral/Black'. The wire which is coloured brown must be connected to the terminal which is marked with the letter 'L' or 'Line/Red'. The wire which is coloured green/yellow must be connected to the terminal which is marked with the letter 'E' or 'Earth/Ground'.



The lightning flash with the crossed-out symbol is a warning symbol for a special precautionary procedure. Within an equipment, a triangle is marked to alert the user to the presence of uninsulated "dangerous voltage" within the product's enclosure that may be of sufficient magnitude to constitute a risk of electric shock.

The exclamation point within an equilateral triangle is intended to alert the user to the presence of important operating and maintenance instructions.

### WARNING

To prevent fire or shock hazard, do not expose this appliance to rain or moisture.

## Warning

Power requirements for electrical equipment differ from one country to another. The operating voltage of the appliance is given in the product manual. If your machine is an equipped before, please check the voltage selector switch on the front panel and the voltage selector switch on the back panel. If the voltage selector switch is set to a voltage other than the operating voltage of the appliance, please contact your dealer for advice. The voltage selector switch is located on the back panel of the appliance. It is used to select the voltage of the power cord. The voltage selector switch is marked with the letter 'V' or 'VOLTAGE SELECTOR'. Do not set for your area. Check that the power cord is the correct type for the voltage selector switch. Always pull out by the plug and never pull the cord out by the plug and socket. Watch out! You might get an electric shock. Never touch the plug with wet hands. Always pull out by the plug and socket.

## Let's protect the Akai MB76 too.

- Use only a household AC power source. Never use a DC power source.
- If water is spilled on the equipment, disconnect the power and call your dealer.
- Make sure that the equipment is well ventilated and away from direct sunlight.
- To avoid damage to the internal circuits and the external surface, keep away from heat (stove, etc.).
- Avoid using spray type insecticide near the equipment. It can damage the finish and might ignite and dent.
- To avoid damaging the finish, never use detergent, alcohol, paint thinner or other similar chemicals to clean the equipment.
- Place the equipment on a flat and solid surface.

To enjoy the Akai MB76 for a long time, please read this operator's manual thoroughly.

Should a problem persist, write down the model serial number and all pertinent data regarding warranty coverage as well as a clear description of the trouble. Then, contact your nearest authorized Service Station or Service Department for assistance.

## Operator's Manual



## Warning

### Power requirements

Power requirements for electrical equipment differ from area to area.

The operating voltage of this machine is preset at the factory according to its intended destination. However, some models are equipped with a voltage selector. If your machine is so equipped, before connecting, check to see that the VOLTAGE SELECTOR on the rear panel is set to the voltage for your area.

**If not, please set it correctly before plugging in the power cord.**

220V, 50Hz for Europe except the UK.

240V, 50Hz for UK and Australia.

120V, 60Hz for USA and Canada.

### If the VOLTAGE SELECTOR is not set for your area:

Confirm that the power cord is disconnected. Move the VOLTAGE SELECTOR with a screwdriver so that the marker is above the voltage for your area.

### What you should know to protect yourself and the Akai MB76

**Watch out! You might get an electric shock.**

- Never touch the plug with wet hands.
- Always pull out by the plug and never the cord.
- Only let a qualified professional repair or reassemble the equipment. An unauthorized person might touch the internal parts and receive a serious electric shock.
- Never allow a child to put anything, especially metal, into the equipment.

### Let's protect the Akai MB76 too.

- Use only a household AC power source. Never use a DC power source.
- If water is spilled on the equipment, disconnect the power and call your dealer.
- Make sure that the equipment is well ventilated and away from direct sunlight.
- To avoid damage to the internal circuits and the external surface, keep away from heat (stoves, etc.)
- Avoid using spray type insecticide near the equipment. It can damage the finish and might ignite suddenly.
- To avoid damaging the finish, never use denatured alcohol, paint thinner or other similar chemicals to clean the equipment.
- Place the equipment on a flat and solid surface.

To enjoy the Akai MB76 for a long time, please read this operator's manual thoroughly.

Should a problem persist, write down the model and serial numbers and all pertinent data regarding warranty coverage as well as a clear description of the existing trouble. Then, contact your nearest authorized Akai Service Station, or the Service Department of Akai Electric Company, Tokyo, Japan.

## Precautions

### FOR CUSTOMERS IN THE UK

#### IMPORTANT FOR YOUR SAFETY

The flex supplied with your machine will have two wires as shown in the illustration.

### TWO CORE FLEX IMPORTANT

The wires in this mains lead are coloured in accordance with the following code:

Blue: Neutral

Brown: Live

As the colours of the wires in the mains lead of this apparatus may not correspond with the coloured markings identifying the terminals in your plug, proceed as follows: The wire which is coloured blue must be connected to the terminal which is marked with the letter N or coloured black.

The wire which is coloured brown must be connected to the terminal which is marked with the letter L or coloured red.

\* Do not connect any wire to the larger pin marked E or  $\oplus$  when wiring a plug. Ensure that all terminals are securely tightened and that no loose strands of wire exist.

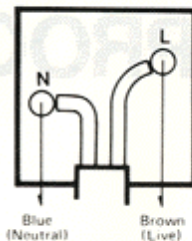



**CAUTION**

RISK OF ELECTRIC SHOCK  
DO NOT OPEN



CAUTION: TO REDUCE THE RISK OF ELECTRIC SHOCK, DO NOT REMOVE COVER (OR BACK). NO USER-SERVICEABLE PARTS INSIDE. REFER SERVICING TO QUALIFIED SERVICE PERSONNEL.



The lightning flash with the arrowhead symbol superimposed across a graphical representation of a person, within an equilateral triangle, is intended to alert the user to the presence of uninsulated "dangerous voltage" within the product's enclosure; that may be of sufficient magnitude to constitute a risk of electric shock.

The exclamation point within an equilateral triangle is intended to alert the user to the presence of important operating and maintenance (servicing) instructions in the literature accompanying the appliance.

**Note:** This unit is not equipped with a voltage selector.



## Features

### CAUTION

To prevent electric shock, do not use this polarized AC power plug with an extension cord receptacle or other outlet unless the blades can be fully inserted to prevent blade exposure.

### LITHIUM BATTERY

This product uses a lithium battery for memory back-up. The lithium battery should only be replaced by qualified service personnel. Improper handling may cause risk of explosion.

Thank you for purchasing the MB76 Akai Programmable Mix Bay.

The MB76 may be set as desired at 7 audio input signal levels. It is a programmable patch bay featuring a mixing function which allows 6 types of output to be transmitted.

This is a detailed presentation including a "Guide to Operations," etc., in order to enable you to take advantage of the outstanding functions of the MB76. Before using the MB76, please read these instructions for use carefully. We recommend that you keep the instructions for use, together with the guarantee, close at hand where they will be easy to locate if needed.

- The 7 input/6 output system of the MB 76 allows a total of 42 types of patch work
- Trimming is possible at each input level over a range of 12 steps, at  $-28\text{ dB} \sim +2\text{ dB}$ .
- Patch work and trimming can be combined for storage in a total of 32 memory banks, and the banks can be changed externally using MIDI.

### Applications

- Optimal for use as a submixer on the multi-keyboard section.
- Outstanding for programmable patching of effectors in a mixing network.
- Convenient as a programmable input/output selector for all kinds of audio devices.



# Nomenclature and Operation of Parts

## Front Panel

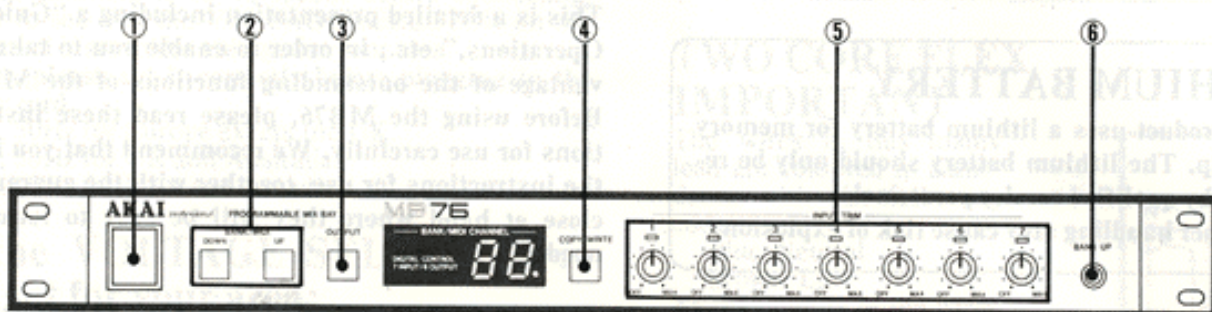

- ① POWER:**  
This is the power switch. When it is set to ON, "00" is displayed.
- ② BANK/MIDI:**  
Used for selecting memory banks and setting MIDI channels. When the UP button is pressed, the value of the number displayed increases, and when DOWN is pressed, it decreases.
- ③ OUTPUT:**  
This button is used for setting the output channel. When "00" is displayed, this button is not operational. Output channel setting is effective when the display shows "01"~"32."  
Can also be used for setting MIDI channel.
- ④ COPY/WRITE:**  
Patching data set on a particular channel can be copied as the data of the next channel, or the multi-patching data of a bank can be faithfully copied to another bank, and the programmed data can be written into the memory bank.

- ⑤ INPUT TRIM (1-7):**  
This knob is used for trimming. Each input level can be adjusted. This is not an ordinary adjustment knob, but a digital control trimming knob. Consequently, changes in gain are made in steps. When the knob is set to the off position, the trim gain becomes "00" and the input signal is not sent to the output jack. Trimming can be carried out within a range of +2 dB ~ -28 dB.
- ⑥ BANK UP:**  
Bank can be changed using a foot switch. Please connect this to the Akai PS-X80.



## Rear Panel

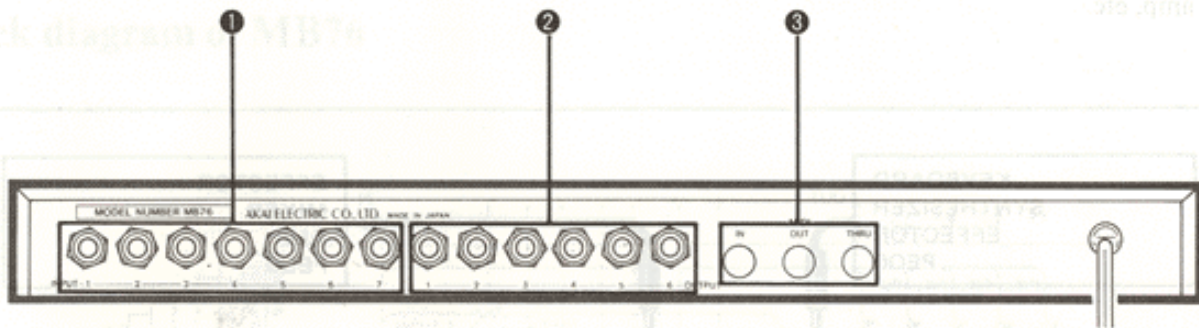

### ① INPUT (1-7):

This is the input terminal. Be sure to use this with line level. Microphone cannot be connected.

### ② OUTPUT (1-6):

This is the output terminal. Optimum load impedance is 10k ohms or above.

### ③ MIDI (IN, OUT, THRU):

Used for connection to external MIDI unit.

IN ⇒ MB76 bank change can be carried out on external MIDI unit.

OUT ⇒ Program change information can be transmitted from MB76 to external MIDI unit.

THRU ⇒ A through terminal for sending information received with MIDI IN.

# 5

## Connection and Operation of Parts

The MB76 input/output jacks are for use with standard phone jacks. A microphone cannot be connected because the input/output level is line level.

**INPUT (1-7):** Connect to "output" of keyboard, synthesizer, effector, etc.

**OUTPUT (1-6):** Connect to "input" of effector, mixer, amp, etc.

**MIDI IN:** Connect to MIDI OUT or MIDI THRU of other MIDI units.

**MIDI OUT:** Connect to MIDI IN of other MIDI units.

**MIDI THRU:** This is also connected to MIDI IN of other MIDI units.

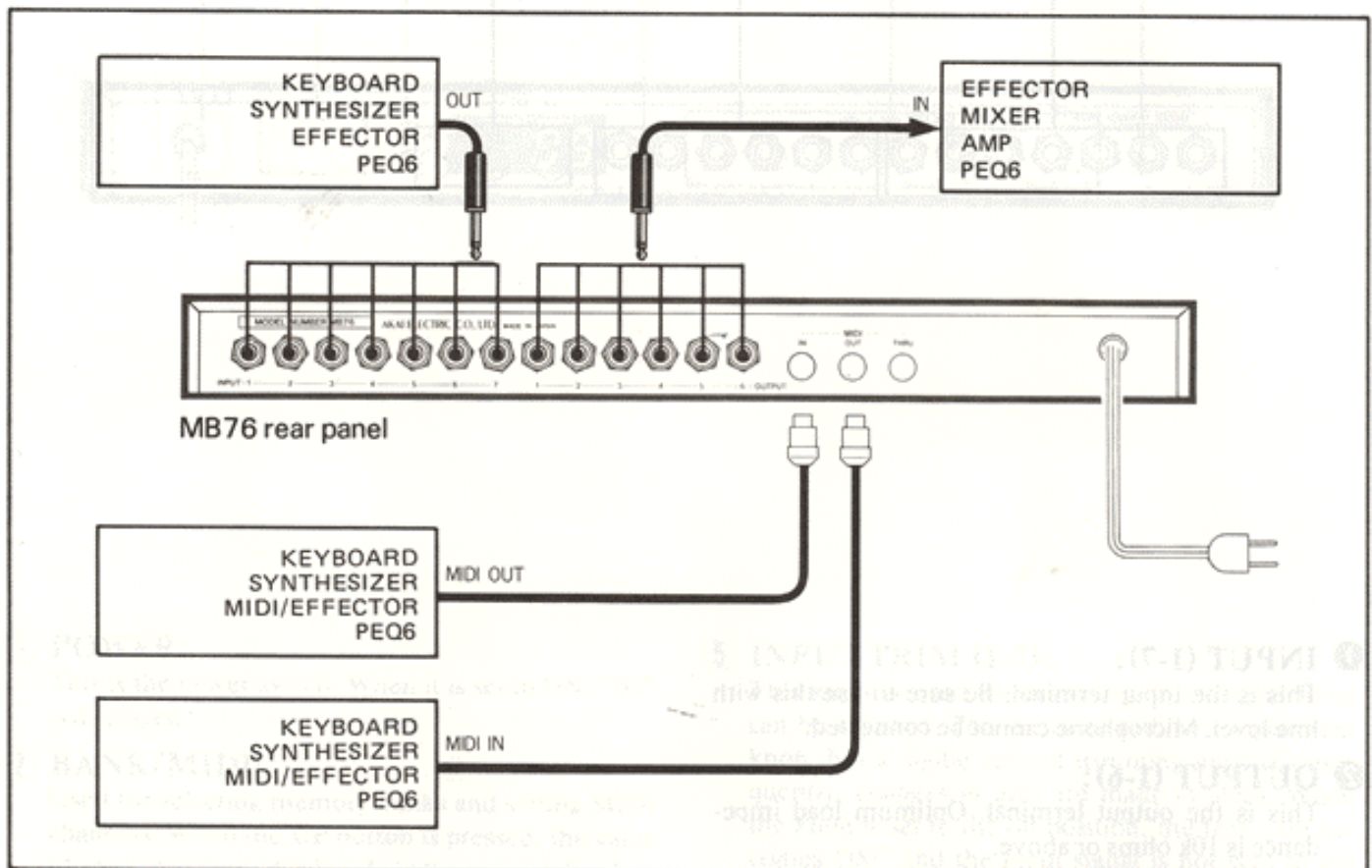

- \* The PEQ6 referred to in the diagram is a 7-band programmable equalizer. Use if for greater effectiveness.



# Operation

When the MB76 is set to ON, "00" is displayed. This is the mode in which 7 in/6 out normal mixing is carried out.

Each input can be connected to 6 channels of each

output. When the OUT button is pressed in this mode, output channels cannot be selected, and data cannot be stored in the memory banks.

## Block diagram of MB76

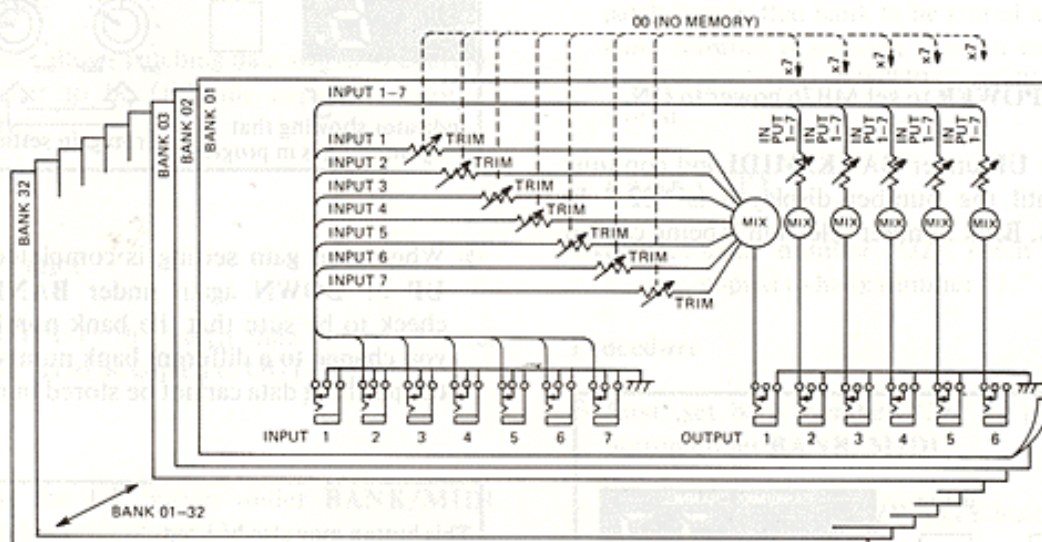

In this operation, a single signal can be distributed to 6 outputs. In addition, 7 input signals are mixed with 6 outputs. Accordingly, when you wish to distribute one input signal only to 6 outputs, set **INPUT TRIM** of the other input channels to OFF.

The LED lights when the input trim is off and the knob is turned clockwise. The signals of channels for which the LED is off are not output to the output jacks. Furthermore, to reset the input trim to on when it is programmed to off as explained below, first put it back to the off position when it is not off and set the trimming level (the LED lights).

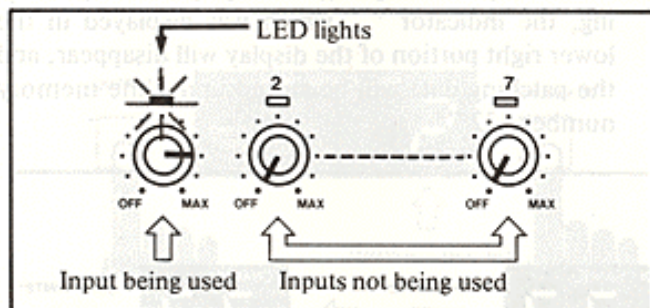



## Programming

As a principle, MB76 is programmed in the order <Bank number selection> ⇒ <Output channel selection> ⇒ <INPUT TRIM SELECTION> ⇒ <Bank number verification> ⇒ <WRITE>.

**Note:** If INPUT "1" and "2" are mixed in output channel "6", the patch data is stored in BANK "32."

### Procedure

- 1 First, press **POWER** to set MB76 power to ON.
- 2 Next, press **UP** under **BANK/MIDI** and continue pressing until the number displayed is "32." In other words, Bank number selection is being carried out.

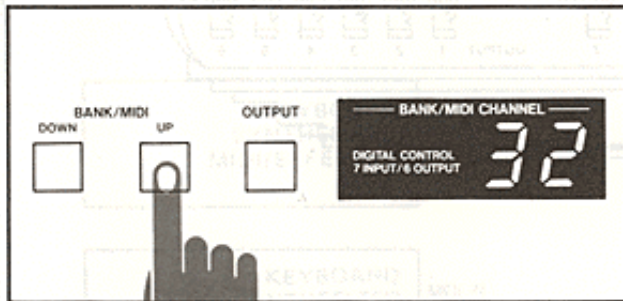

- 3 Then, press the **OUTPUT** button 6 times and set the number displayed to "6".

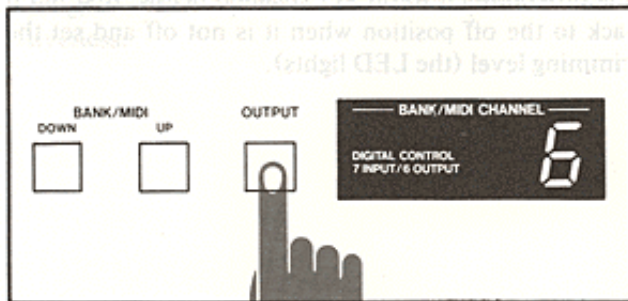

- 4 Adjust "1" and "2" under **INPUT TRIM** to set trimming gain. When the knob is turned from the OFF position to the right, "." appears in the lower right portion of the display. This is an indicator showing that programming is in progress.

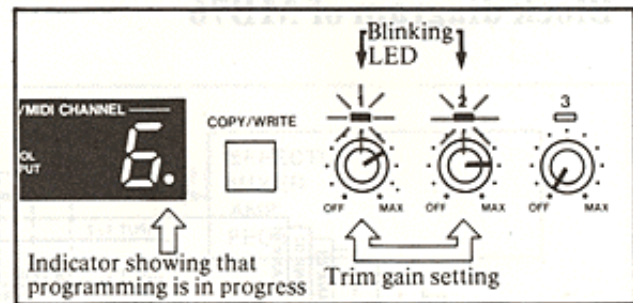

- 5 When trim gain setting is completed, press either **UP** or **DOWN** again under **BANK/MIDI**, and check to be sure that the bank number is "32." If you change to a different bank number at this time, the patching data cannot be stored in memory.

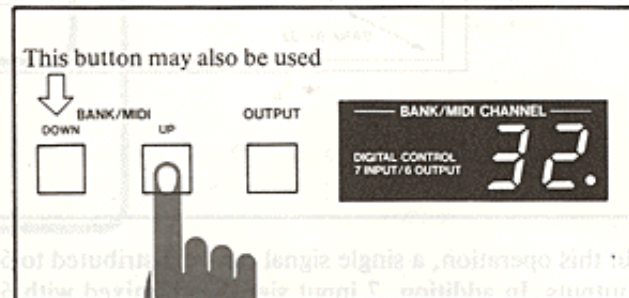

- 6 After verifying the bank number you wish to store in memory, press the **COPY/WRITE** button. The display will blink on and off. If the **COPY/WRITE** button is pressed again, the display will stop blinking, the indicator "." which was displayed in the lower right portion of the display will disappear, and the patching data will be stored under the memory number "32."

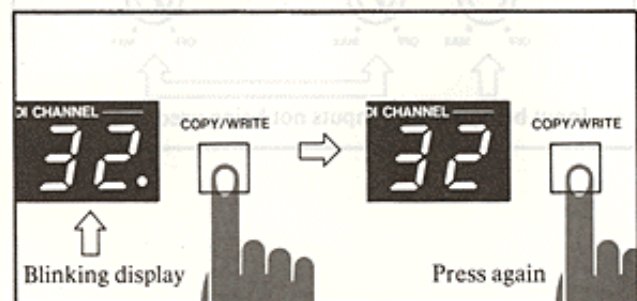



## Patch Data Copy Function

The MB76 has 2 kinds of patching data copy functions.

### 1. OUTPUT COPY

This is a copy function for operations carried out before storage in the memory banks. It allows patching data set at a certain OUTPUT channel to be copied to another OUTPUT channel.

### 2. BANK COPY

This function allows patching data stored at a certain bank number to be faithfully copied to another bank number.

## Copying

### 1. OUTPUT COPY

**Example:** OUTPUT "6" patch data set at channel "32" is to be copied to OUTPUT "2."

#### Procedure

- ① First, press the **UP** button under **BANK/MIDI** and set it to bank number "32."
- ② Next, press the **OUTPUT** button and set the OUTPUT channel to "6."
- ③ When the **OUTPUT** button is pressed after the **COPY/WRITE** button, the output channel is set to "2." The display blinks on and off.

- ④ Press the **COPY/WRITE** button again. The display will stop blinking and "copying completed" will be displayed.
- ⑤ When the **UP** or **DOWN** button under **BANK/MIDI** is pressed once (do not press it twice, the <OUTPUT COPY> bank number data appears on the display.
- ⑥ Press the **COPY/WRITE** button twice. This causes the data written into the <OUTPUT COPY> patch data in that bank to be stored anew. If another bank number is selected without carrying out this "restorage," the <OUTPUT COPY> data is not stored.

### 2. BANK COPY

**Example:** bank number "32" patch data is to be copied to bank number "1."

#### Procedure

- ① First, set bank number "32" by pressing the **UP** button under **BANK/MIDI**.
- ② Next, press the **COPY/WRITE** button. The display will blink on and off.
- ③ Then, set bank number "1" by pressing the **DOWN** button under **BANK/MIDI**.
- ④ Press the **COPY/WRITE** button again. The display will stop blinking and change to "copying completed."

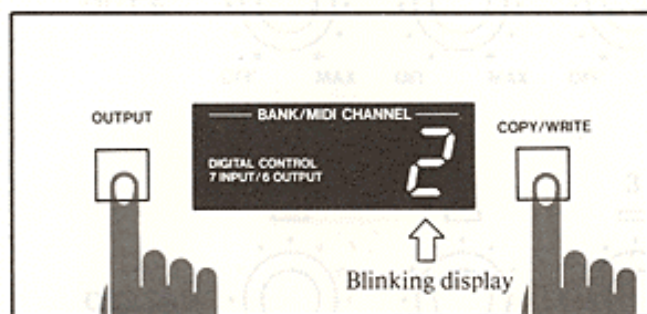



### Patch Data All Clear Function

The MB76 has a function which can clear all stored patch data.

**Operation:** If the **POWER** is set to ON while simultaneously pressing the **UP** and **DOWN** buttons under **BANK/MIDI**, the memory is fully cleared, and the **INPUT TRIM** data is all initialized to the "OFF" state.

### Bank up Function Using Foot Switch

When a foot switch, such as the AKAI PS-X80, is connected to the **BANK UP** on the front panel, the bank number can be switched (**BANK UP**) using the foot switch. The bank number increases by one each time the switch is pressed, and it returns to "1" after "32."

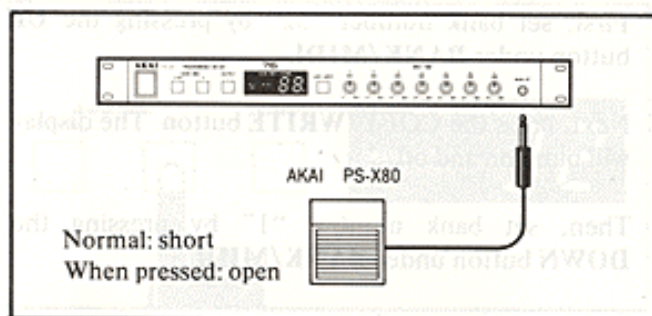

When shipped from the factory, the MIDI channel setting on the MB76 is set to "CH.1." If it is set to anything else, the following operations should be performed.

- ① First, set the **POWER** to ON while simultaneously pressing the **OUTPUT** and **COPY/WRITE** buttons.
- ② Next, use the **UP** or **DOWN** button under **BANK/MIDI** to set the desired MIDI channel (1-16).
- ③ Then, press the **OUTPUT** button. The number displayed will change to "00," and the unit will go into normal mixer mode.
- ④ Using the **UP** or **DOWN** button under **BANK/MIDI**, select the bank number.

**Note** The new MIDI channel setting remains stored in memory even when the power is turned off. If you wish to change the setting once again, reset it following the above procedures.



# MB76 DATA SHEET

BANK No. \_\_\_\_\_

OUT 1

1 2 3 4 5 6 7

OFF MAX OFF MAX OFF MAX OFF MAX OFF MAX OFF MAX OFF MAX

OUT 2

1 2 3 4 5 6 7

OFF MAX OFF MAX OFF MAX OFF MAX OFF MAX OFF MAX OFF MAX

OUT 3

1 2 3 4 5 6 7

OFF MAX OFF MAX OFF MAX OFF MAX OFF MAX OFF MAX OFF MAX

OUT 4

1 2 3 4 5 6 7

OFF MAX OFF MAX OFF MAX OFF MAX OFF MAX OFF MAX OFF MAX

OUT 5

1 2 3 4 5 6 7

OFF MAX OFF MAX OFF MAX OFF MAX OFF MAX OFF MAX OFF MAX

OUT 6

1 2 3 4 5 6 7

OFF MAX OFF MAX OFF MAX OFF MAX OFF MAX OFF MAX OFF MAX

Make a copy of this sheet.

**AKAI** professional



# Specifications

- Type:** ..... Programmable digital control mixing bay
- Number of input/output channels:** ..... Input: 7 ch.  
Output: 6 ch.
- Basic input/output level:** ..... Input: 0 dBm  
Output: 0 dBm  
(optimum load 10 k ohms or above)
- Maximum input level:** ... + 20 dBm
- Input/output impedance:** ..... Input: 47 k ohms  
Output: 600 ohms
- Frequency characteristics:** 20 Hz ~ 20 kHz ( $\pm 0.5$  dB)
- Trimmer gain:** ..... +2 ~ -28dB, infinity (12 steps)
- S/N ratio:** ..... -95 dB (IHF)
- Crosstalk:** ..... -70 dB (1 kHz, 0 dBm input)
- Functions:** ..... BANK/MIDI, DOWN, UP OUTPUT COPY/WRITE INPUT TRIM (1-7)
- Display:** ..... 7-segment LED (2 columns)
- Connection terminals:** ... MIDI; IN, OUT, THRU (DIN 5P)  
INPUT: 7 (standard phone jack)  
OUTPUT: 6 (standard phone jack)  
BANK UP: (using standard phone jack/foot switch)
- Power consumed:** ..... 8 W
- External dimensions:** ... 480 (W) x 43 (H) x 120 (D) mm
- Weight:** ..... 2 kg

\* Specifications and external dimensions may be changed without notice for purposes of improvement.

**AKAI**  
AKAI ELECTRIC CO., LTD.

12-14, 2-chome, Higashi-Kojima,  
Ohta-ku, Tokyo, Japan



Printed in Japan  
©620714D1 620717-01