

Technics

KEYBOARD

SX-KN2400

SX-KN2600

Operating Instructions



Before connecting, operating or adjusting this product, please read these instructions completely. Please keep this manual for future reference.



Caution for AC Mains Lead

(For United Kingdom) (For the type as shown in figures A and B)

For your safety, please read the following text carefully.

This appliance is supplied with a moulded three pin mains plug for your safety and convenience. A 5-ampere fuse is fitted in this plug. Should the fuse need to be replaced please ensure that the replacement fuse has a rating of 5-ampere and that it is approved by ASTA or BSI to BS1362.

Check for the ASTA mark  or the BSI mark

 on the body of the fuse.

If the plug contains a removable fuse cover you must ensure that it is refitted when the fuse is replaced. If you lose the fuse cover the plug must not be used until a replacement cover is obtained. A replacement fuse cover can be purchased from your local dealer.

CAUTION!

IF THE FITTED MOULDED PLUG IS UNSUITABLE FOR THE SOCKET OUTLET IN YOUR HOME THEN THE FUSE SHOULD BE REMOVED AND THE PLUG CUT OFF AND DISPOSED OF SAFELY. THERE IS A DANGER OF SEVERE ELECTRICAL SHOCK IF THE CUT OFF PLUG IS INSERTED INTO ANY 13-AMPERE SOCKET.

If a new plug is to be fitted please observe the wiring code as stated below. If in any doubt please consult a qualified electrician.

IMPORTANT

The wires in this mains lead are coloured in accordance with the following code:

Blue: Neutral, Brown: Live.

As these colours may not correspond with the coloured markings identifying the terminals in your plug, proceed as follows:

The wire which is coloured Blue must be connected to the terminal which is marked with the letter N or coloured Black or Blue.

The wire which is coloured Brown must be connected to the terminal which is marked with the letter L or coloured Brown or Red.

WARNING: DO NOT CONNECT EITHER WIRE TO THE EARTH TERMINAL WHICH IS MARKED WITH THE LETTER E, BY THE EARTH SYMBOL \perp OR COLOURED GREEN OR GREEN/ YELLOW.

**THIS PLUG IS NOT WATERPROOF
—KEEP DRY.**

Before use

Remove the connector cover.

How to replace the fuse

The location of the fuse differ according to the type of AC mains plug (figures A and B). Confirm the AC mains plug fitted and follow the instructions below. Illustrations may differ from actual AC mains plug.

1. Open the fuse cover with a screwdriver.

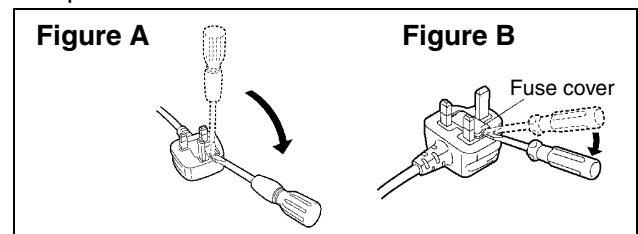

2. Replace the fuse and close or attach the fuse cover.

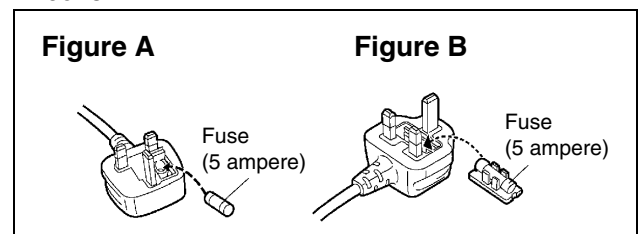

For United Kingdom and Republic of Ireland

*shop@***Panasonic**

www.panasonic.co.uk (for UK customers only)

- Order accessory and consumable items for your product with ease and confidence by telephoning our Customer Care Centre Mon–Friday 9:00am–5:30pm. (Excluding public holidays.)
- Or go on line through our Internet Accessory ordering application.
- Most major credit and debit cards accepted.
- All enquiries transactions and distribution facilities are provided directly by Panasonic UK Ltd.
- It couldn't be simpler!

Customer Care Centre

For UK customers: 08705 357357 For Republic of Ireland customers: 01 289 8333

Technical Support

For UK customers: 0870 1 505610



This Technical Support Hot Line number is for Panasonic PC software related products only.

For Republic of Ireland, please use the Customer Care Centre number listed above for all enquiries.

For all other product related enquiries, please use the Customer Care Centre numbers listed above.

THE FOLLOWING APPLIES ONLY
IN THE U.S.A. AND CANADA

THE FOLLOWING APPLIES
ONLY IN THE U.S.A.

	CAUTION RISK OF ELECTRIC SHOCK DO NOT OPEN	
CAUTION: TO REDUCE THE RISK OF ELECTRIC SHOCK, DO NOT REMOVE SCREWS. NO USER-SERVICEABLE PARTS INSIDE. REFER SERVICING TO QUALIFIED SERVICE PERSONNEL.		



The lightning flash with arrowhead symbol, within an equilateral triangle, is intended to alert the user to the presence of uninsulated "dangerous voltage" within the product's enclosure that may be of sufficient magnitude to constitute a risk of electric shock to persons.



The exclamation point within an equilateral triangle is intended to alert the user to the presence of important operating and maintenance (servicing) instructions in the literature accompanying the appliance.

(for U.S.A. and Canada)

CAUTION: TO PREVENT ELECTRIC SHOCK MATCH WIDE BLADE OF PLUG TO WIDE SLOT, FULLY INSERT.

WARNING: TO REDUCE THE RISK OF FIRE, ELECTRIC SHOCK OR PRODUCT DAMAGE, DO NOT EXPOSE THIS APPARATUS TO RAIN, MOISTURE, DRIPPING OR SPLASHING AND THAT NO OBJECTS FILLED WITH LIQUIDS, SUCH AS VASES, SHALL BE PLACED ON THE APPARATUS.
--

THE FOLLOWING APPLIES ONLY IN THE U.S.A.

Notice: This product has a fluorescent lamp that contains a small amount of mercury. It also contains lead in some components. Disposal of these materials may be regulated in your community due to environmental considerations. For disposal or recycling information please contact your local authorities, or the Electronics Industries Alliance: < http://www.eiae.org >

CAUTION:

This equipment has been tested and found to comply with the limits for a Class B digital device, pursuant to Part 15 of the FCC Rules. These limits are designed to provide reasonable protection against harmful interference in a residential installation. This equipment generates, uses and can radiate radio frequency energy and, if not installed and used in accordance with the instructions, may cause harmful interference to radio communications. However, there is no guarantee that interference will not occur in a particular installation. If this equipment does cause harmful interference to radio or television reception, which can be determined by turning the equipment off and on, the user is encouraged to try to correct the interference by one or more of the following measures:

- Reorient or relocate the receiving antenna.
- Increase the separation between the equipment and receiver.
- Connect the equipment into an outlet on a circuit different from that to which the receiver is connected.
- Consult the dealer or an experienced radio/TV technician for help.

FCC Warning:

To assure continued FCC emission limit compliance, use only the provided power supply cord and the shielded interface cable when connecting this device to the computer.

Also, any unauthorized changes or modifications to this equipment would void the user's authority to operate this device.

This device complies with Part 15 of the FCC Rules. Operation is subject to the following two conditions: (1) This device may not cause harmful interference, and (2) this device must accept any interference received, including interference that may cause undesired operation.

Responsible Party:

Matshshita Electric Corporation of America
One Panasonic Way
Secaucus, NJ, 07094 USA
Telephone No.: 1-800-211-7262

The model number and serial number are found underneath the keyboard.

Please note the model and serial numbers in the space provided below and retain this sheet as a permanent record of your purchase to aid identification in the event of theft.

MODEL NUMBER

SERIAL NUMBER

THIS UNIT IS INTENDED FOR USE IN TROPICAL CLIMATES.
DENNA ENHET ÄR AVSEDD FÖR ANVÄNDNING PÅ PLATSER MED TROPISKT KLIMAT.
TÄMÄ LAITE ON TARKOITETTU KÄYTETTÄVÄKSI TROOPPISESSA ILMASTOSSA.
DETTE APPARATET ER BEREGNET TIL BRUK UNDER TROPISKE KLIMAFORHOLD.

VAROITUS:

TULIPALO-, SÄHKÖISKUVAARAN TAI TUOTETTA KOHTAAVAN MUUN VAHINGON VÄHENTÄMISEKSI EI LAITETTA SAA ALTISTAA SATEELLE, KOSTEUELLE, VESIPISAROILLE TAI ROISKEELLE, EIKÄ NESTETTÄ SISÄLTÄVIÄ ESINEITÄ, KUTEN ESIMERKIKSI MALJAKOITA, SAA ASETTAA LAITTEEN PÄÄLLE.

ADVARSEL:

FOR Å REDUSERE FAREN FOR BRANN, ELEKTRISK STØT ELLER SKADER PÅ PRODUKTET, MÅ DETTE APPARATET IKKE UTSETTES FOR REGN, FUKTIGHET, VANNDRÅPER ELLER VANNSPRUT. DET MÅ HELLER IKKE Plasseres GJENSTANDER FYLT MED VANN, SLIK SOM BLOMSTERVASER, OPPÅ APPARATET.

OSTRZEŻENIE:

ABY OGRANICZYĆ NIEBEZPIECZEŃSTWO POŻARU, PORAŻENIA PRĄDEM LUB USZKODZENIA URZĄDZENIA, NIE NALEŻY WYSTAWIAĆ URZĄDZENIA NA DZIAŁANIE DESZCZU, WILGOCI, KAPANIE LUB ZACHLAPANIE; PONADTO NA URZĄDZENIU NIE NALEŻY USTAWIAĆ ŻADNYCH NACZYŃ ZAWIERAJĄCYCH PŁYNY, TAKICH JAK WAZONY.

VARNING:

FÖR ATT MINSKA RISKEN FÖR ELDSVÅDA, ELEKTRISKA STÖTAR OCH SKADOR PÅ PRODUKTEN FÅR DEN INTE UTSÄTTAS FÖR REGN, FUKTIGHET, VATTENDROPPAR ELLER VATTENSTÄNK, OCH INGA FÖREMÅL SOM ÄR FYLDA MED VÄTSKA, SÅ SOM VASER, BÖR PLACERAS PÅ APPARATEN.

AVISO:

PARA REDUZIR O RISCO DE INCÊNDIO, CHOQUE ELÉCTRICO OU AVARIAS, NÃO EXPONHA O APARELHO À CHUVA, HUMIDADE, PINGOS OU SALPICOS NEM COLOQUE EM CIMA DELE OBJECTOS COM LÍQUIDOS COMO, POR EXEMPLO, UM JARRO.

CAUTION!

- DO NOT INSTALL OR PLACE THIS UNIT IN A BOOK-CASE, BUILT-IN CABINET OR IN ANOTHER CONFINED SPACE. ENSURE THE UNIT IS WELL VENTILATED. TO PREVENT RISK OF ELECTRIC SHOCK OR FIRE HAZARD DUE TO OVERHEATING, ENSURE THAT CURTAINS AND ANY OTHER MATERIALS DO NOT OBSTRUCT THE VENTILATION VENTS.
- DO NOT OBSTRUCT THE UNIT'S VENTILATION OPENINGS WITH NEWSPAPERS, TABLECLOTHS, CURTAINS, AND SIMILAR ITEMS.
- DO NOT PLACE SOURCES OF NAKED FLAMES, SUCH AS LIGHTED CANDLES, ON THE UNIT.
- DISPOSE OF BATTERIES IN AN ENVIRONMENTALLY FRIENDLY MANNER.

VAROITUS!

- ÄLÄ ASENNATA TAI LAITATA TÄTÄ LAITETTA KABINETTITYYPPISEEN KIRJAKAAPPIIN TAI MUUHUN SULJETTUUN TILAAN, JOTTA TUULETUS ONNISTUISI. VARMISTA, ETTÄ VERHO TAI MIKÄÄN MUU MATERIAALI EI HUONONNA TUULETUSTA, JOTTA VÄLTETTÄISIIN YLIKUUMENEMISESTA JOHTUVA SÄHKÖISKU- TAI TULIPALOVAARA.
- ÄLÄ PEITÄ LAITTEEN TUULETUSAUKKOJA SANOMALEHDELLÄ, PÖYTÄLIINALLA, VERHOLLA TAI MUULLA VASTAAVALLA ESINEELLÄ.
- ÄLÄ ASETA PALAVAA KYNTTILÄÄ TAI MUUTA AVOTULEN LÄHDETTÄ LAITTEEN PÄÄLLE.
- HÄVITÄ PARISTOT LUONTOA VAHINGOITAMATTOMALLA TAVALLA.

ADVARSEL!

- APPARATET MÅ IKKE Plasseres I EN BOKHYLLE, ET INNEBYGGET KABINETT ELLER ET ANNET LUKKET STED HVOR VENTILASJONSFORHOLDENE ER UTILSTREKKELIGE. SØRG FOR AT GARDINER ELLER LIGNENDE IKKE FORVERRER VENTILASJONSFORHOLDENE, SÅ RISIKO FOR ELEKTRISK SJOKK ELLER BRANN FORÅRSAKET AV OVERHETING UNNGÅS.
- APPARATETS VENTILASJONSÅPNINGER MÅ IKKE DEKKES TIL MED AVISER, BORDDUKER, GARDINER OG LIGNENDE.
- Plasser IKKE ÅPEN ILD, SLIK SOM LEVENDE LYS, OPPÅ APPARATET.
- BRUKTE BATTERIER MÅ KASSERES UTEN FARE FOR MILJØET.

UWAGA!

- NINIEJSZEGO URZĄDZENIA NIE NALEŻY INSTALOWAĆ LUB UMIESZCZAĆ W SZAFCE NA KSIĄŻKI, ZABUDOWANEJ SZAFCE LUB INNEJ OGRANICZONEJ PRZESTRZENI, W CELU ZAPEWNIENIA DOBREJ WENTYLACJI. NALEŻY SIĘ UPEWNIĆ, ŻE ZASŁONY I INNE MATERIAŁY NIE ZASŁANIAJĄ OTWORÓW WENTYLACYJNYCH TAK, ABY ZAPOBIEC RYZYKU PORAŻENIA PRĄDEM LUB POŻARU W WYNIKU PRZEGRZANIA.
- NIE ZASŁANIAJ OTWORÓW WENTYLACYJNYCH URZĄDZENIA GAZETAMI, OBRUSAMI, ZASŁONAMI I PODOBNYMI PRZEDMIOTAMI.
- NIE UMIESZCZAJ NA URZĄDZENIU ŹRÓDEŁ OTWARTEGO OGNIA, TAKICH JAK ZAPALONE ŚWIECE.
- POZBYWAJ SIĘ ZUŻYTYCH BATERII W SPOSÓB NIE ZAGRAŻAJĄCY ŚRODOWISKU NATURALNEMU.

VARNING!

- FÖR ATT APPARATEN SKA FÅ GOD VENTILATION, INSTALLERA ELLER PLACERA DEN INTE I EN BOKHYLLA, ETT INBYGGT SKÅP ELLER I ANDRA BEGRÄNSADE UTRYMMEN. FÖR ATT FÖREBYGGA RISK FÖR ELSTÖTAR OCH BRAND PÅ GRUND AV ÖVERHETTNING, KONTROLLERA ATT GARDINER ELLER ANDRA FÖREMÅL INTE FÖRHINDRAR APPARATENS VENTILERING.
- SE TILL ATT ENHETENS VENTILATIONSÖPPNINGAR INTE ÄR FÖRTÄPPTA AV TIDNINGAR, BORDSDUKAR, GARDINER ELLER LIKNANDE FÖREMÅL.
- STÄLL INGA FÖREMÅL MED ÖPPEN LÅGA, SÅ SOM ETT TÄNT STEARINLJUS, OVANPÅ ENHETEN.
- GÖR DIG AV MED BATTERIER PÅ ETT MILJÖVÄNLIGT SÄTT.

AVISO!

- NÃO INSTALE OU COLOQUE ESTE APARELHO DENTRO DE UMA ESTANTE, ARMÁRIO EMBUTIDO OU QUALQUER OUTRO ESPAÇO FECHADO. VERIFIQUE SE EXISTE UMA BOA VENTILAÇÃO PARA O APARELHO. PARA EVITAR O RISCO DE CHOQUE ELÉCTRICO OU INCÊNDIO PROVOCADO POR SOBREAQUECIMENTO, CERTIFIQUE-SE DE QUE AS ABERTURAS DE VENTILAÇÃO NÃO ESTÃO TAPADAS COM AS CORTINAS OU QUALQUER OUTRO MATERIAL.
- NÃO TAPE AS RANHURAS DE VENTILAÇÃO COM JORNAIS, TOALHAS, CORTINADOS OU OBJECTOS SEMELHANTES.
- NÃO COLOQUE OBJECTOS COM CHAMAS, COMO VELAS ACESAS, EM CIMA DO APARELHO.
- DEITE FORA AS PILHAS RESPEITANDO AS REGRAS DE DEFESA DO AMBIENTE.

只限於台灣

緊急處理方法

為防止使用者及其他人之危害及生命財產的損失，如有發生異常時，請立即拔出電源綫插頭並停止使用。

進口商名稱、地址及電話
松下資訊科技股份有限公司
台灣台北市信義路5段2號5~6樓
TEL : 886-2-2725-9100

IMPORTANT SAFETY INSTRUCTIONS

Read these operating instructions carefully before using the unit. Follow the safety instructions on the unit and the safety precautions listed below. Keep these operating instructions handy for future reference.

Safety

- 1. Power Source**—Connect the unit to a power source of the type described in these instructions or as marked on the unit.
- 2. Polarization**—The unit is equipped with a polarized power plug where one blade is wider than the other. This safety feature ensures that the plug fits into your household AC outlet only one way. If the plug doesn't fit one way, try reversing it. If the plug still doesn't fit, contact an electrician to replace the obsolete outlet. Do not attempt to defeat the safety purpose of the plug.
- 3. Power Cord protection**—Route the AC power supply cord so that it will not be walked on or pinched by items placed on or against it. Never take hold of the plug or cord with wet hands. Always grasp the plug body firmly when connecting and disconnecting it.
- 4. Overloading**—When connecting the AC power supply cord, be careful not to overload the household AC outlet, extension cord, or outlet from any other device as this can result in fire or electric shock.
- 5. Nonuse periods**—Turn the unit off when it is not in use. Unplug the unit from the household AC outlet if it is not to be used for a long time. Unplug the unit during lightning storms.
- 6. Attachments and accessories**—Use only the attachments and accessories recommended in these operating instructions.

Installation

Placement

- 1. Ventilation**—Situate the unit so that it receives proper ventilation. Do not install in a confined space such as a bookcase or cabinet. Allow at least 10 cm (4 inches) clearance from the rear of the unit. To prevent the risk of electric shock or fire due to overheating ensure curtains and other materials do not obstruct the unit's ventilation.
- 2. Foreign material**—Ensure objects and liquids do not get into the unit. Avoid exposing the unit to excessive smoke, dust, mechanical vibration, and shock.
- 3. Magnetism**—Situate the unit away from equipment and devices that generate strong magnetic fields.
- 4. Stacking**—Do not place heavy objects on top of this unit.
- 5. Surface**—Place the unit on a flat, level surface.

- 6. Carts and stands**—Use the unit only with carts and stands recommended by the manufacturer. Move carts with care. Sudden stops, excessive force, and uneven surfaces can cause carts to overturn.



- 7. Wall and ceiling mounting**—Do not mount the unit on walls or ceilings unless specified in the instructions.

Environment

- 1. Water and moisture**—Do not use the unit near water, such as near a bathtub or swimming pool. Avoid damp basements.
- 2. Heat**—Situate the unit away from heat sources, such as radiators. Do not situate where temperatures fall below 5°C (41°F) or rise above 35°C (95°F).

Maintenance

(See page 6 for details.)

Unplug the unit from the household AC outlet before cleaning.
Clean with a damp cloth.
Do not use abrasive pads, scouring powders, or solvents.

Service

- 1. Damage Requiring Service**—The unit should be serviced by qualified service personnel if:
 - (a) The AC power supply cord or the plug has been damaged; or
 - (b) Objects or liquids have gotten into the unit; or
 - (c) The unit has been exposed to rain; or
 - (d) The unit does not operate normally or exhibits a marked change in performance; or
 - (e) The unit has been dropped or the cabinet damaged.
- 2. Servicing**—Do not attempt to service the unit beyond that described in these operating instructions. Refer all other servicing to authorized servicing personnel.
- 3. Replacement parts**—When parts need replacing ensure the servicer uses parts specified by the manufacturer or parts that have the same characteristics as the original parts. Unauthorized substitutes may result in fire, electric shock, or other hazards.
- 4. Safety check**—After repairs or service, ask the servicer to perform safety checks to confirm that the unit is in proper working condition.

Cautions for safest use of this unit

Installation location

1. A well-ventilated place.
Take care not to use this unit in a place where it will not receive sufficient ventilation, and not to permit the ventilation holes to be covered by curtains, or any similar materials.
2. Place away from direct sunlight and excessive heat from heating equipment.
3. A place where humidity, vibration and dust are minimized.

Power source

1. Be sure the line voltage selector is in accordance with local voltage in your area before connecting the plug to the socket.
2. DC power cannot be used.

Handling the power cord

1. Never touch the power cord, or its plug, with wet hands.
2. Don't pull the power cord.

Metal items inside the unit may result in electric shock or damage.

Do not permit metal articles to get inside the unit.

Be especially careful with regard to this point if children are near this unit. They should be warned never to try to put anything inside.

If, nevertheless, some such article does get inside, disconnect the power cord plug from the electrical outlet, and contact the store where the unit was purchased.

If water gets into the unit

Disconnect the power cord plug from the electrical outlet, and contact the store where it was purchased.

As a precaution, it is suggested that flower vases and other containers which hold liquids not be placed on the top of this unit.

If operation seems abnormal

Immediately turn off the power, disconnect the power cord plug from the electrical outlet, and contact the store where it was purchased.

Discontinue using the unit at once. Failure to do so may result in additional damage or some other unexpected damage or accident.

- Because the power source is located inside the unit, it is normal for the cabinet to become warm.

A word about the power cord

If the power cord is scarred, is partially cut or broken, or has a bad contact, it may cause a fire or serious electrical shock if used. NEVER use a damaged power cord for any appliance. Moreover, the power cord should never be forcibly bent.

Don't touch the inside parts of this unit.

Some places inside this unit have high voltage potential. Never try to remove the top or back panels of this unit, or to touch inside parts by hand or with tools.

Contact someone who is qualified in order to inspect the inside, or to replace a fuse, if such becomes necessary. Never attempt to do these things yourself.

Maintenance

The following suggestions will assist you in keeping the unit in top condition.

- Be sure to switch the instrument off after use, and do not switch the unit on and off in quick succession, as this places an undue load on the electronic components.
- To keep the luster of the surface and buttons, simply use a clean, damp cloth; polish with a soft, dry cloth. Polish may be used but do not use thinners or petro-chemical-based polishes.
- A wax-based polish may be used on the cabinet, although you will find that rubbing with a soft cloth will suffice.

-
- This product may receive radio interference caused by mobile telephones during use. If such interference is apparent, please increase separation between the product and the mobile telephone.
 - Keep the SD Memory Card out of the reach of children to prevent them from swallowing it. (KN2600)

SVENSK:

- Det kan inträffa att den här produkten under användningen tar emot radiostörningar, orsakade av mobiltelefoner. Öka avståndet mellan produkten och mobiltelefonen om störningarna är uppenbara.
- Håll SD-minneskortet utom räckhåll för barn, för att förhindra att ett barn sväljer det. (KN2600)

**SERVICE MUST BE CARRIED OUT BY DEALER
OR OTHER QUALIFIED PERSON**

Contents

Cautions for safest use of this unit.....	6
Controls and functions (KN2400).....	10
Controls and functions (KN2600).....	12

BASIC FUNCTIONS

Getting started	14
See and listen to the demonstration	16
Add effects	17
Play back commercial song disks (DIRECT PLAY) (KN2400).....	18
Play back SD cards (SD-AUDIO PLAY) (KN2600).....	19
Select the registration for a music style (MUSIC STYLIST)	20
Automatic panel settings (ONE TOUCH PLAY).....	22
Store your panel settings (PANEL MEMORY).....	24
Record your performance (SEQUENCER)	25
Save data on an SD card (KN2600)	27
Load rhythm data from a Technics pattern disk (COMPOSER LOAD) (KN2400).....	29

PRACTICAL APPLICATIONS

About the display	30
Favorites	33
Part I Sounds and effects	35
Overview of sounds and effects.....	35
Selecting sounds.....	36
Digital Drawbar	37
Assigning parts to the keyboard.....	39
Effects	41
Controller	45
Transpose	46
Techni-chord	47
Part II Playing the rhythm	48
Overview of rhythm performance.....	48
Selecting rhythms	49
Playing the rhythm	51
Auto Play Chord.....	52
Fade In/Fade Out.....	57
Sound Arranger.....	59
One Touch Play	60
Music Stylist	60
Music Style Arranger.....	62
Panel Memory	64
Part III Performance Pads	67
Playing phrases	67
Copying phrases	68
Compile	70
Record a phrase	71
Part IV Sequencer	73
Outline of the Sequencer	73
Sequencer parts.....	76
Easy Record	77
Realtime Record	78

Sequencer Play.....	81
Naming.....	83
Panel Write	83
Song Select.....	84
Punch Record	84
Step Record	86
Track Assign	91
Quantize.....	92
Song Clear	93
Track Clear	93
Note Edit	94
Drum Edit.....	95
Copy and paste the recorded data.....	97
Changing the note position etc. of the recorded data	101
SD Audio Synchro (KN2600)	103
Part V Composer	104
Outline of the Composer.....	104
Simple recording method.....	106
Create a completely new rhythm	106
Chord Modify Change	109
Part Setting	110
Playback	111
Step Record	111
Measure Edit.....	112
Pattern Copy	115
Part VI Disk Drive (KN2400)	117
Outline of the Disk Drive function.....	117
Outline of the procedure	119
Loading data	120
Direct Play.....	122
Song Medley	124
Saving data	125
Disk management.....	128
Set the automatic display when a disk is inserted	130
Part VII SD Card (KN2600).....	131
Outline of the SD card.....	131
Loading data	133
SD-Audio Play.....	136
SD-Sound Play	137
Playlist.....	138
SD Song Medley	139
Saving Data	140
Create an album of your favorite songs.....	143
SD card management.....	144
Set the priority of displays.....	145
Part VIII Sound	146
Outline of the Sound	146
Part Setting	147
Mixer	150
Master Tuning	152
Key Scaling	152
Sound Load Option.....	153
APC Reverb Setting.....	154
Part IX Reverb & Effect.....	155
Outline of the Reverb & Effect	155

Tone Control	156
Part X Sound Edit	157
Outline of the Sound Edit.....	157
Easy Edit.....	158
Tone Edit.....	159
Pitch Edit.....	162
Filter Edit.....	163
Amplitude Edit.....	165
LFO Edit.....	167
Effect Edit.....	168
Controller Edit	169
Store the new sound	169
Part XI Control	171
Outline of Control functions.....	171
Overall Touch Sensitivity	172
Foot Controllers	172
Part XII Customize	174
Outline of Customize functions	174
Display Time Out	175
Data Protection	176
MIDI Setting Load Option.....	176
Part XII MIDI	177
What is MIDI?	177
Outline of MIDI functions.....	179
Part Setting	180
Control Messages	181
Realtime Messages	181
Common Setting	182
Mode Setting.....	183
Input/output Setting.....	183
MIDI Presets	184
Computer Connection	185
Initialize	186
About the performance data	187
Separately sold options	187
Terminals	188
Symptoms which appear to be signs of trouble	189
Error messages	191
Index	193
Specifications	195

■ **Supplied accessories**

please check the supplied accessories.



- Music stand
- CD-ROM
- AC cord
- SD Card (KN2600)

Controls and functions (KN2400)

MUSIC STYLIST

You can choose to have all the settings of this instrument automatically set. (Refer to page 60.)

RHYTHM GROUP

Various rhythm patterns are available for each rhythm group. (Refer to page 49.)

AUTO PLAY CHORD

Add an automatic accompaniment to your selected rhythm. (Refer to page 52.)

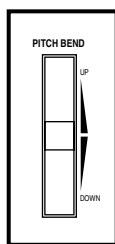
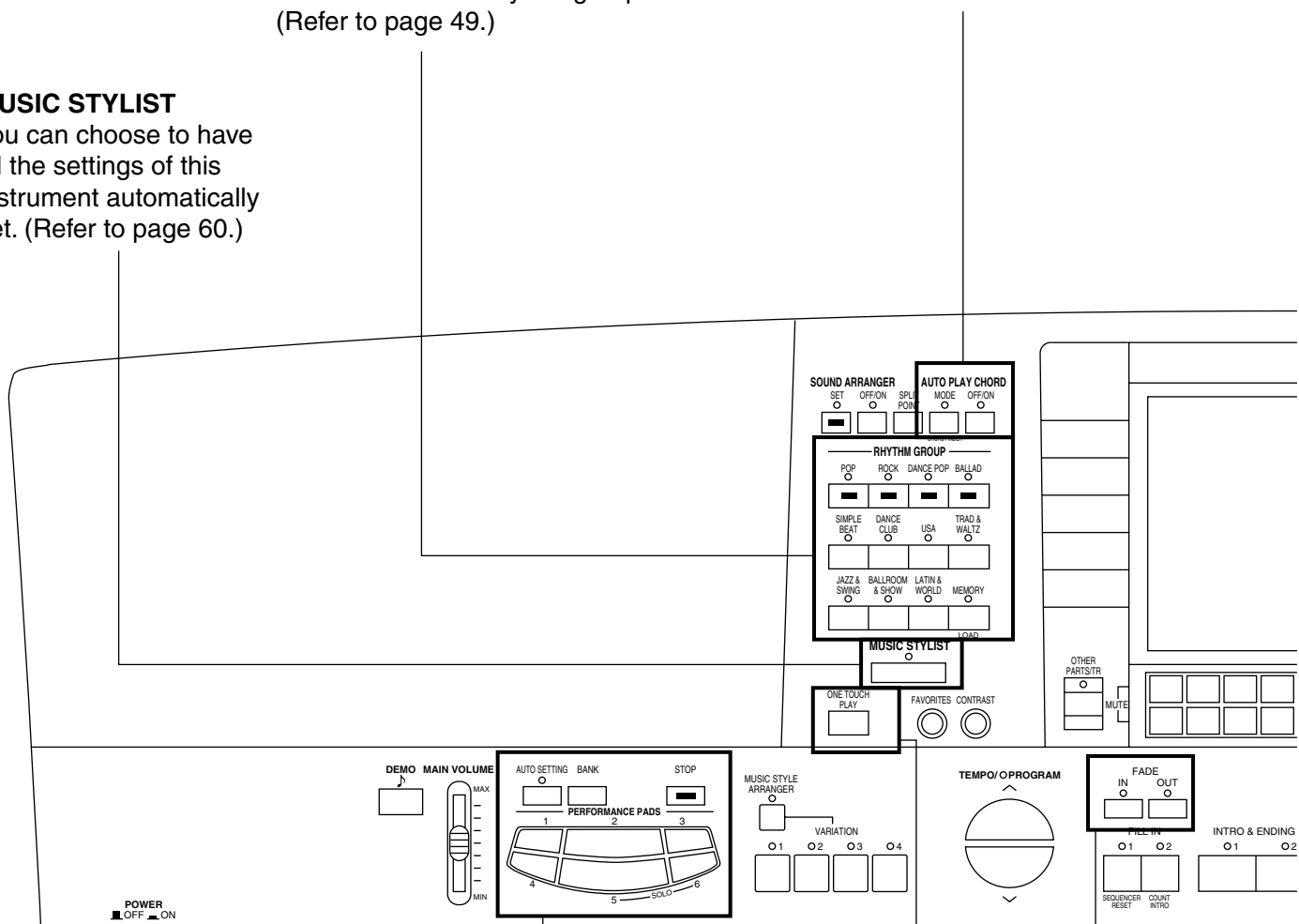

PITCH BEND

The **PITCH BEND** wheel allows a “sliding” change in the pitch. (Refer to page 45.)

PERFORMANCE PADS

Add various phrases to your performance with the pad buttons. (Refer to page 67.)

ONE TOUCH PLAY

Sounds and effects matching the selected rhythm are automatically set. (Refer to page 60.)

FADE IN/OUT

Begin your song with a slowly increasing volume, or end it by having the sound slowly fade away. (Refer to page 57.)

DISPLAY

Displays performance information, function settings and other messages.

(Refer to page 30.)

- Use the **CONTRAST** buttons to adjust the display so that it is easy to read.

EFFECT

Add various effects to the sounds. (Refer to page 41.)

TRANPOSE

Raise or lower the key of the entire keyboard. (Refer to page 46.)

SOUND GROUP

Various sounds are available for each sound group. (Refer to page 36.)

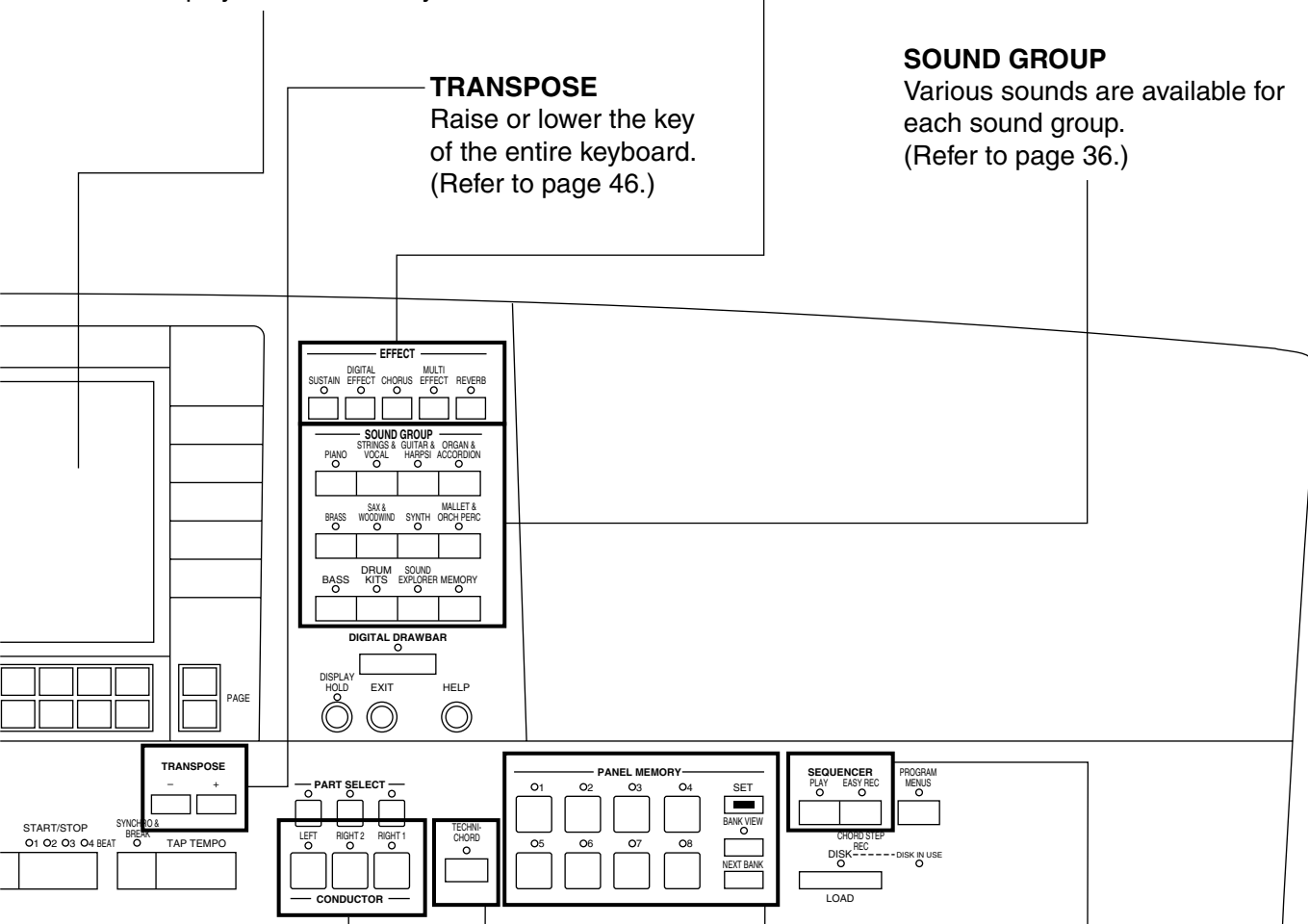

TECHNI-CHORD

Block chords are automatically added to the melody. (Refer to page 47.)

SEQUENCER

Record and play back your performance. (Refer to page 73.)

CONDUCTOR

Assign a different sound to each part, then assign the desired parts to section of the keyboard. (Refer to page 39.)

PANEL MEMORY

Store the panel settings, then recall them instantaneously just by pressing a button or two. (Refer to page 64.)

Controls and functions (KN2600)

MUSIC STYLIST
You can choose to have all the settings of this instrument automatically set. (Refer to page 60.)

RHYTHM GROUP
Various rhythm patterns are available for each rhythm group. (Refer to page 49.)

AUTO PLAY CHORD
Add an automatic accompaniment to your selected rhythm. (Refer to page 52.)

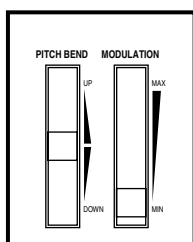
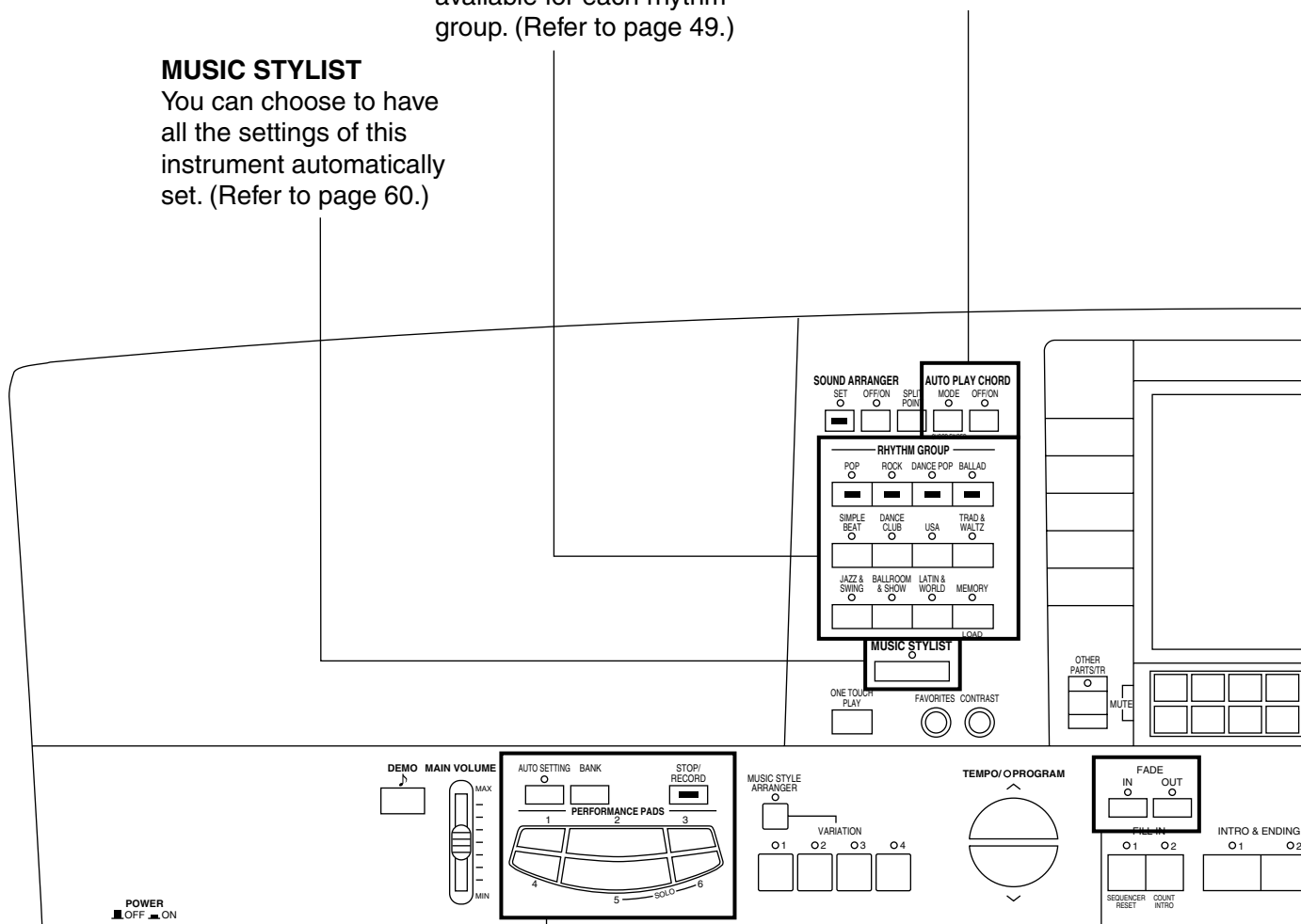

PITCH BEND/MODULATION
The **PITCH BEND** wheel allows a “sliding” change in the pitch. The **MODULATION** wheel is used to add vibrato to the sound. (Refer to page 45.)

PERFORMANCE PADS
Add various phrases to your performance with the pad buttons. (Refer to page 67.)

FADE IN/OUT
Begin your song with a slowly increasing volume, or end it by having the sound slowly fade away. (Refer to page 57.)

DISPLAY

Displays performance information, function settings and other messages.
(Refer to page 30.)

- Use the **CONTRAST** buttons to adjust the display so that it is easy to read.

EFFECT

Add various effects to the sounds. (Refer to page 41.)

TRANPOSE

Raise or lower the key of the entire keyboard.
(Refer to page 46.)

SOUND GROUP

Various sounds are available for each sound group.
(Refer to page 36.)

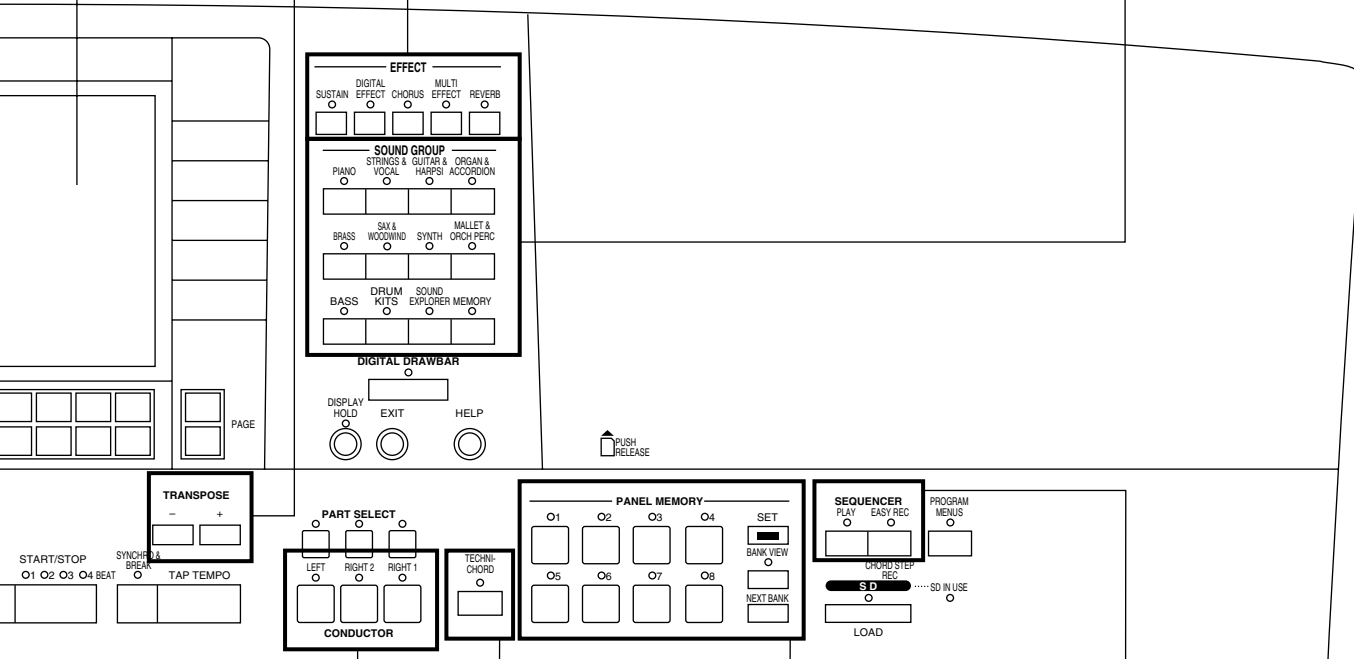

TECHNI-CHORD

Block chords are automatically added to the melody. (Refer to page 47.)

SEQUENCER

Record and play back your performance.
(Refer to page 73.)

CONDUCTOR

Assign a different sound to each part, then assign the desired parts to section of the keyboard.
(Refer to page 39.)

PANEL MEMORY

Store the panel settings, then recall them instantaneously just by pressing a button or two. (Refer to page 64.)

Getting started

Before you play

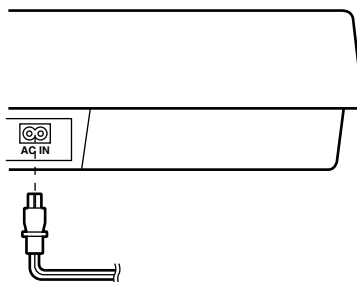

1 Plug the power cord into an outlet.

2 Affix the music stand as shown.

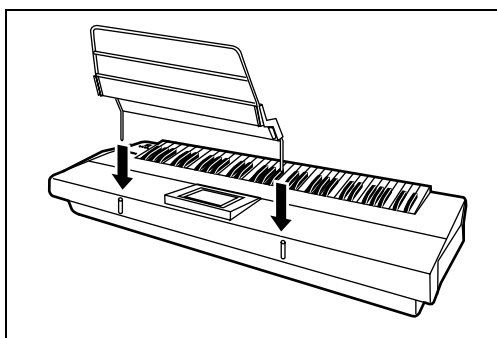

3 Press the **POWER** button to turn it on. (Located on the left of the keyboard)

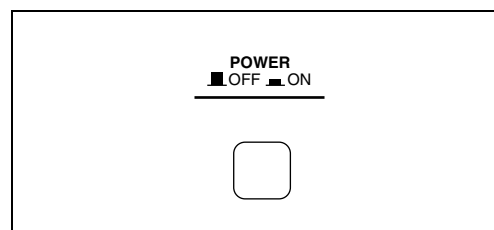

- Headphones may be plugged into the **PHONES** terminal. (Rear panel) This will automatically switch off the speaker system, and sound is heard only through the headphones.

- The pitch of this instrument can be adjusted for when playing with other instruments. (Refer to page 152.)
- Under certain conditions, the functions and memories of this instrument may be initialized when the power is turned on.

Playing

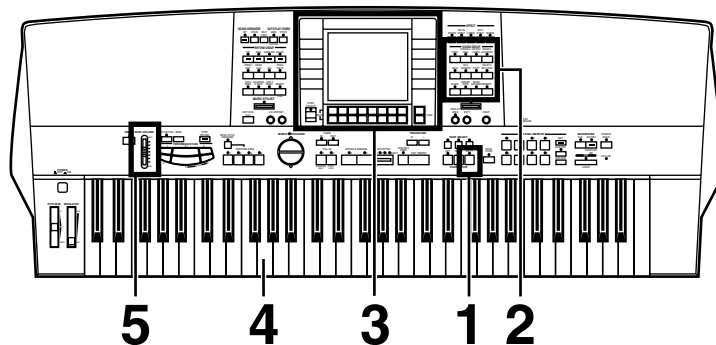

- 1** In the **CONDUCTOR** section on the panel, press the **RIGHT 1** button to turn it on.

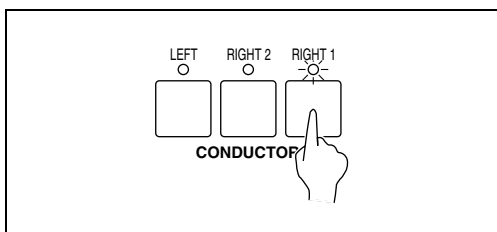

- 2** In the **SOUND GROUP** section, press one of the sound buttons.

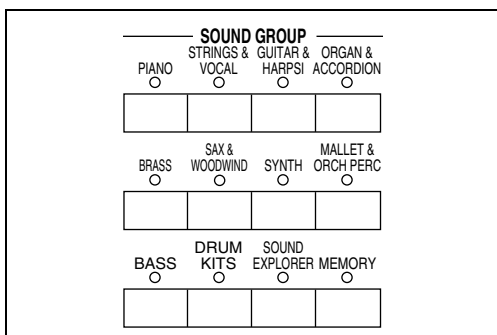

- 3** Select a sound from the list of sounds shown on the display.

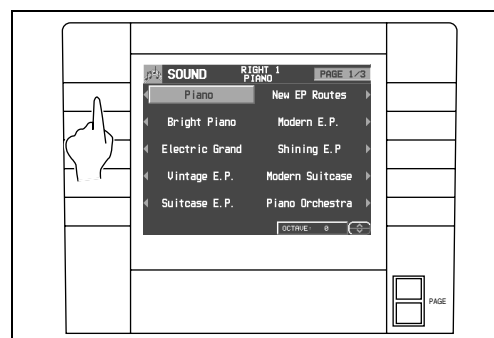

- The list of sounds is contained on two or more screen “pages”. To see a different part of the list, press either **PAGE** button.

- 4** Play the keyboard.
- Your Keyboard features Touch Response. You control the volume by playing the keys harder or softer.

- 5** Set the **MAIN VOLUME** to an appropriate level with the sliding control.

- Refer to page 36 for detailed information about selecting sounds.

See and listen to the demonstration

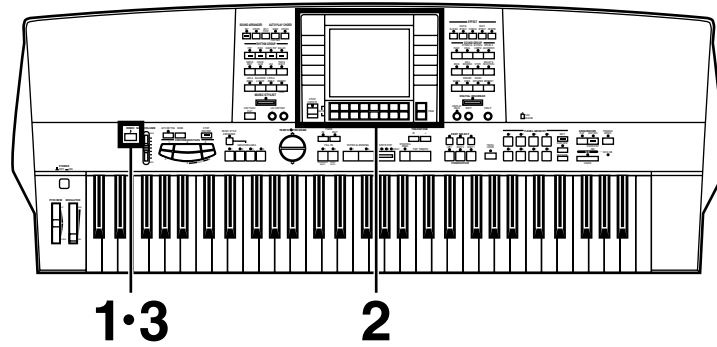

1 Press the **DEMO** button.

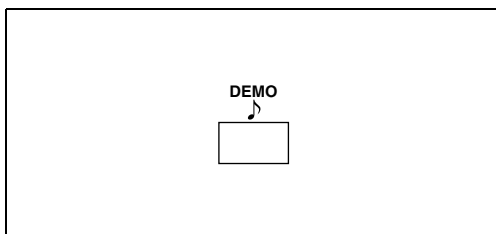

- The demonstration performance and display corresponding to your selection will begin.
- To end the demonstration before it has finished, press the **START/STOP** button.

2 Use the buttons to the left and right the display to select the demonstration tune you wish to see and listen to.

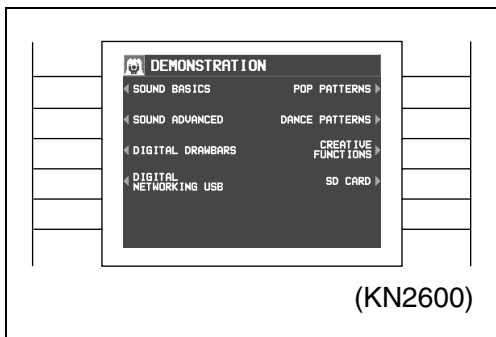

3 When you are finished listening to the demonstration tunes, press the **DEMO** button again.

- If you press and hold the **DEMO** button for a few seconds, or if you press first the **DEMO** button and then the **START/STOP** button, all demo tunes are demonstrated in order in a medley performance. The medley

- performance continues until the **START/STOP** button or the **DEMO** button is pressed again.
- Some of the buttons do not function during the DEMO mode.

Add effects

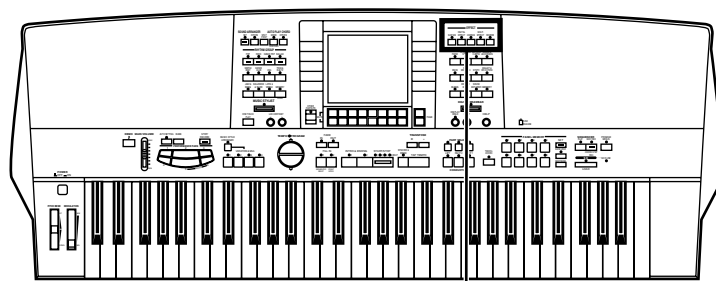

A·B·C

Add breadth.

A

Press the **CHORUS** button to turn it on.

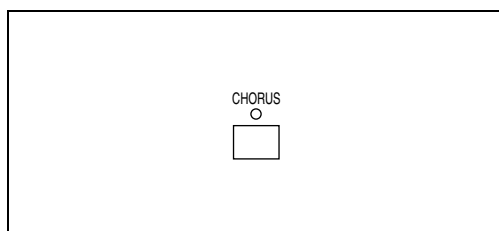

Add reverberation.

C

Press the **REVERB** button to turn it on.

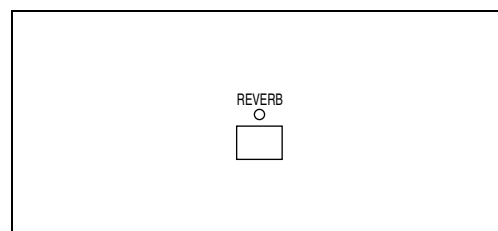

Add effect.

B

Press the **MULTI EFFECT** button to turn it on.

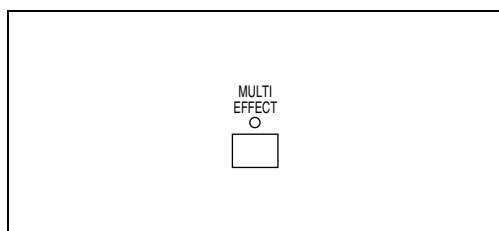

-
- You can modify the way in which the various effects are applied. (Refer to page 42.)

Play back commercial song disks

(DIRECT PLAY) (KN2400)

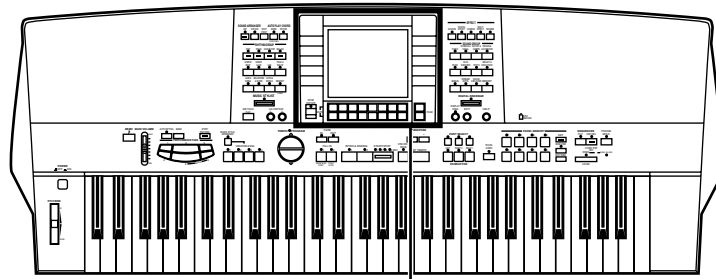

2-3-4

- 1** Insert the song disk into the Disk Drive slot.

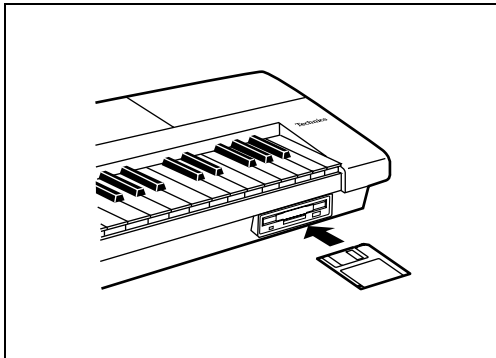

- 2** On the DISK MENU display, select DIRECT PLAY.

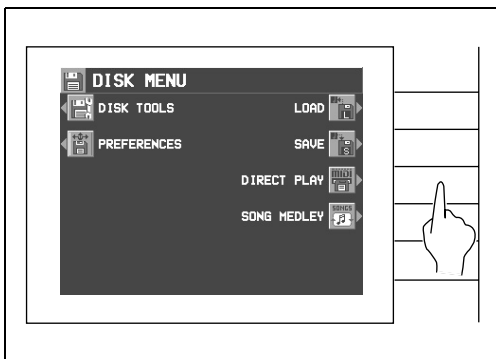

- 3** Use the buttons below the display to select a song.

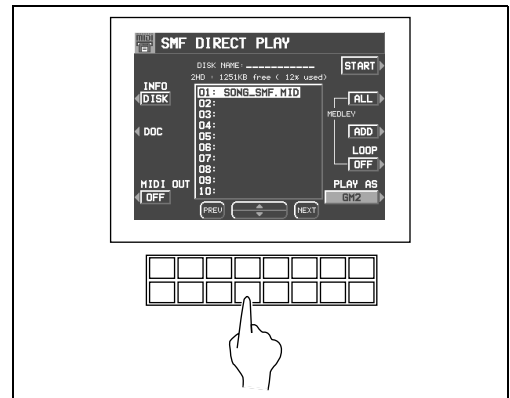

- For SMF songs, use the PLAY AS button to specify a sound arrangement mode.

- 4** Press the START button.
- The selected song is played back.

- DIRECT PLAY is possible from the following disks:

Standard MIDI File
Standard MIDI File with Lyrics
DISK ORCHESTRA COLLECTION™ (DOC)
PianoDisc™

* All product and company names are trademarks or registered trademarks of their respective owners.

* DISK ORCHESTRA COLLECTION is a trademark of the YAMAHA Corporation.

Play back SD cards

(SD-AUDIO PLAY) (KN2600)

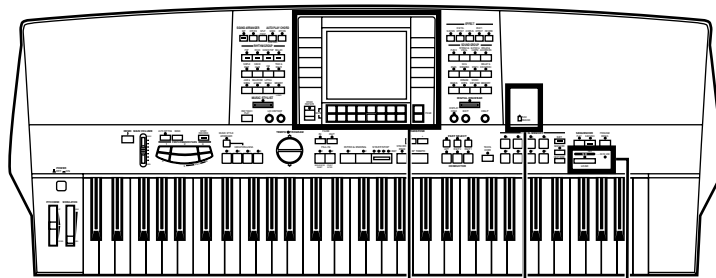

5·6 1·2·3 4

1 Open the lid of the SD slot.

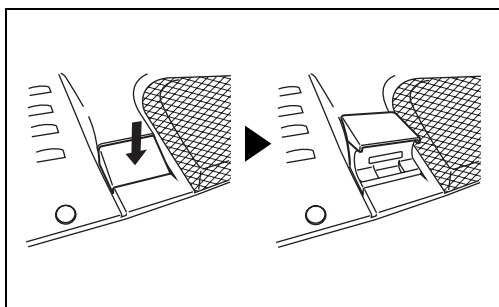

- Open it completely.

2 Insert an SD card with the stored songs into the SD slot.

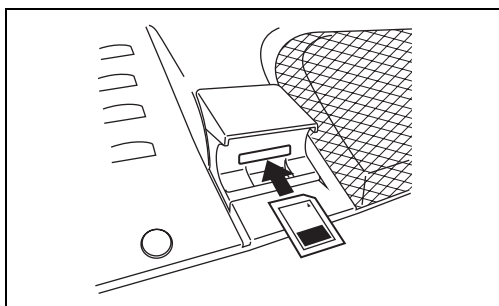

- Push the card until it locks.

3 Close the lid.

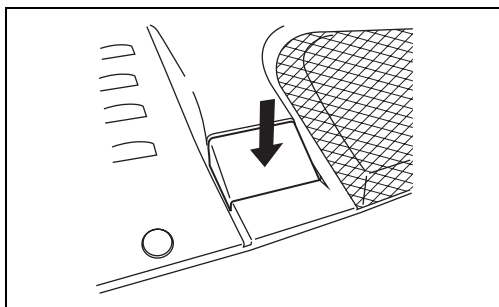

- No operation is possible when the lid is open.

4 Press the **SD** button to turn it on.

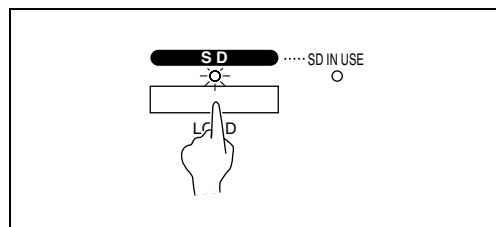

5 On the SD MENU display, select SD-AUDIO PLAY.

6 Press the Playback button.

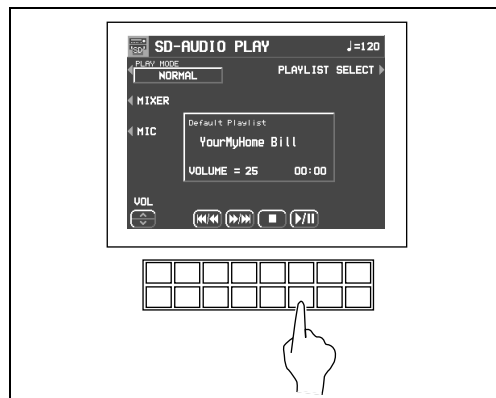

- Playback of the first song begins.

Select the registration for a music style (MUSIC STYLIST)

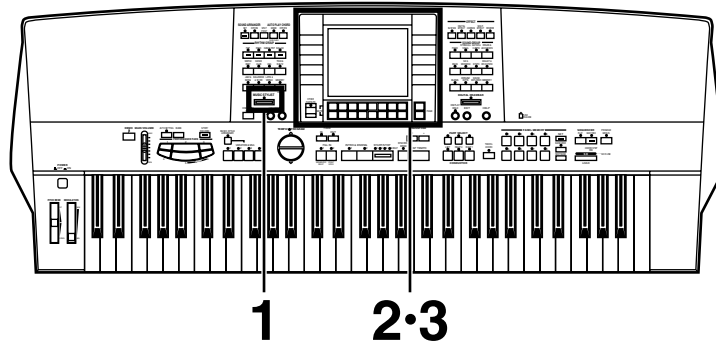

- 1** Press the **MUSIC STYLIST** button to turn it on.

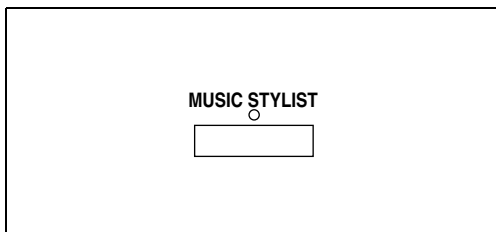

- 3** Use the **CATEGORY** ▲ and ▼ buttons to select a category.

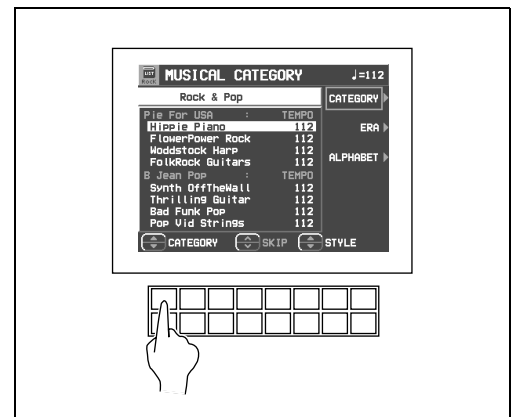

- 2** Select **MUSICAL CATEGORY**.

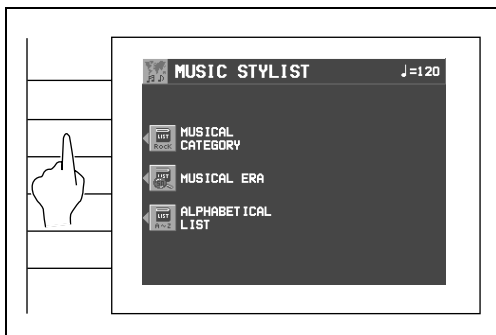

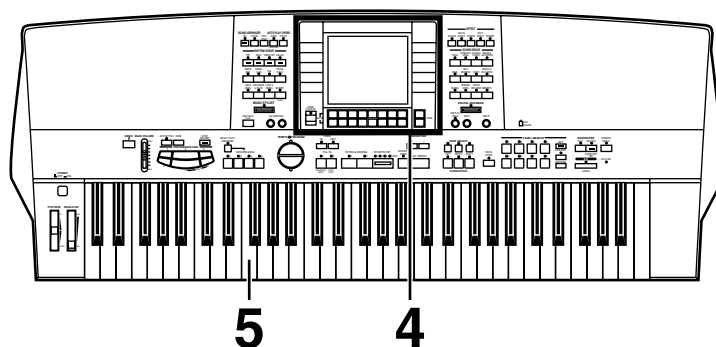

- 4** Use the STYLE ▲ and ▼ buttons to select a music style.

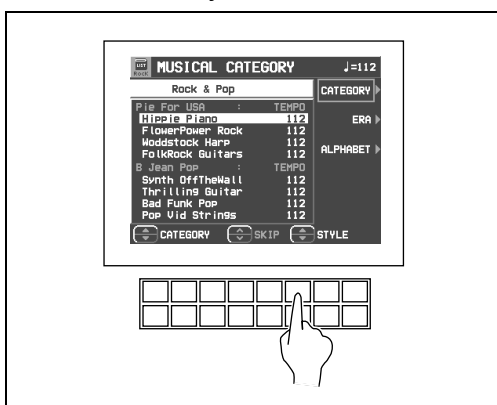

- You can use the SKIP ▲ and ▼ buttons to skip to the previous or following sub category.
- When you select a style, the sounds and rhythm which are best suited for the selected style are automatically selected.

- 5** Play the keyboard.
- When you specify a chord, an intro is played, after which the automatic rhythm starts.

- You can also search for a style alphabetically or by music era. (Refer to page 61.)

Automatic panel settings

(ONE TOUCH PLAY)

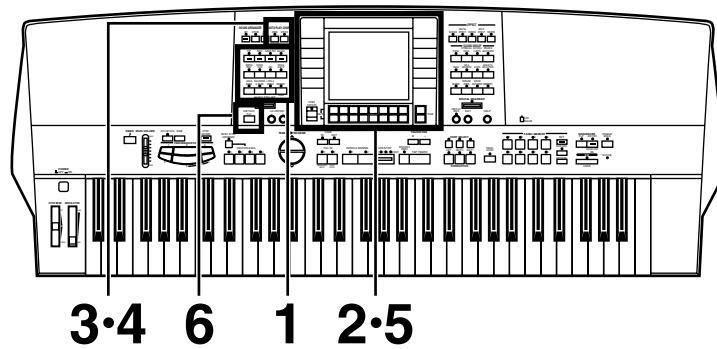

1 In the **RHYTHM GROUP** section, press the button for a desired rhythm.

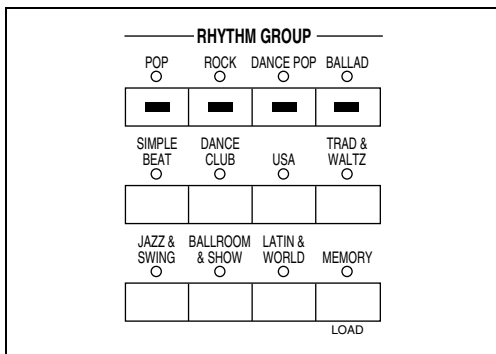

- Do not select the **MEMORY** button.

2 Select a rhythm from the list of rhythms on the display.

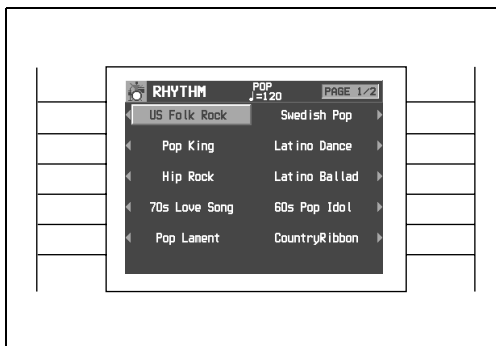

3 Press the **AUTO PLAY CHORD's OFF/ON** button to turn it on..

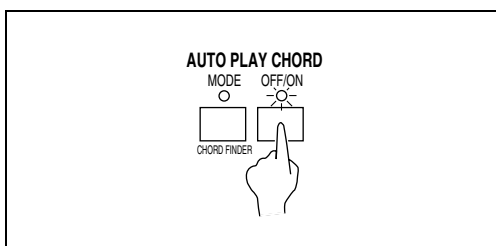

4 Press the **AUTO PLAY CHORD's MODE** button to turn it on.

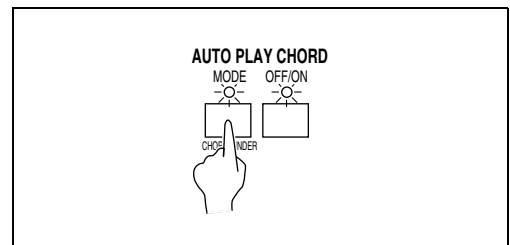

5 Select **BASIC** on the display.

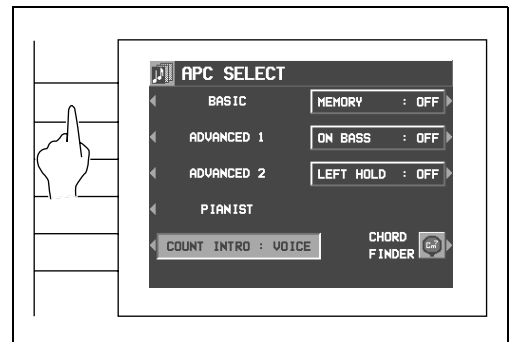

6 Press and hold the **ONE TOUCH PLAY** button for a few seconds.

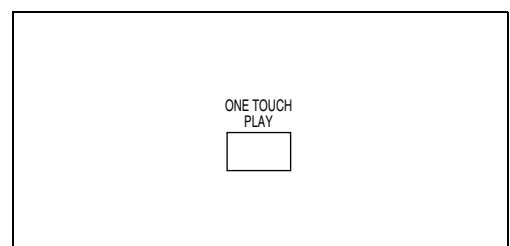

- The sound, effects and tempo suitable for the selected rhythm are automatically selected. The tempo can be adjusted with the **TEMPO/PROGRAM**.

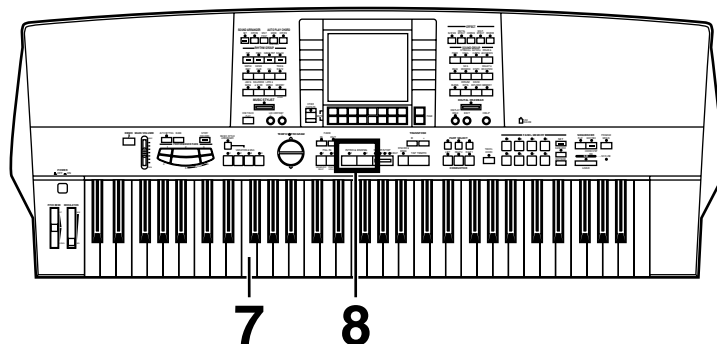

- 7** Use your left hand to play the chords and your right hand to play the melody.
- Pressing a key on the left area of the keyboard will cause the automatic rhythm pattern to start playing (synchro start).

- 8** At the end of your performance, press the **INTRO & ENDING 1** or **2** button.

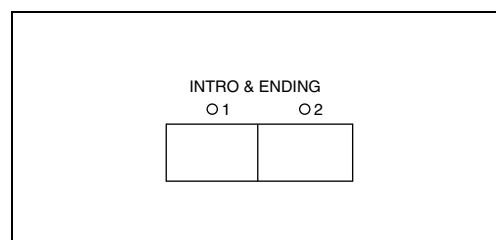

- An ending pattern is played, after which the automatic accompaniment stops.
- If the **START/STOP** button is pressed, the accompaniment stops immediately.

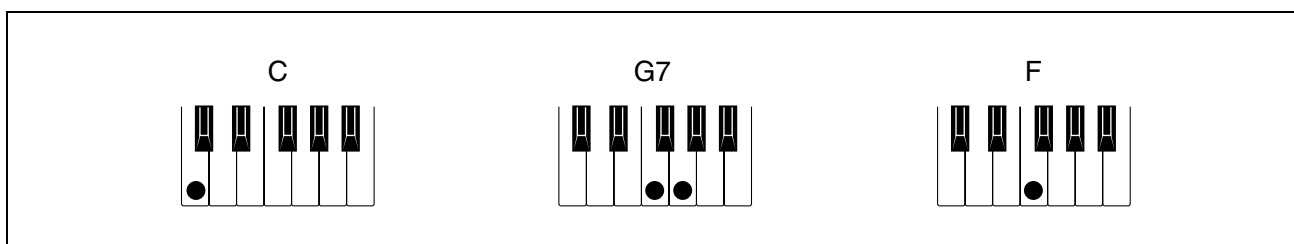

- In this example you played chords by pressing the keys for the “root notes” (ONE FINGER chords). But you can also specify the chord by playing all the notes in the chord. (Refer to page 52.)
- You can insert a fill-in pattern while the rhythm pattern is playing by pressing either the **FILL IN 1** or **FILL IN 2** button.

Store your panel settings

(PANEL MEMORY)

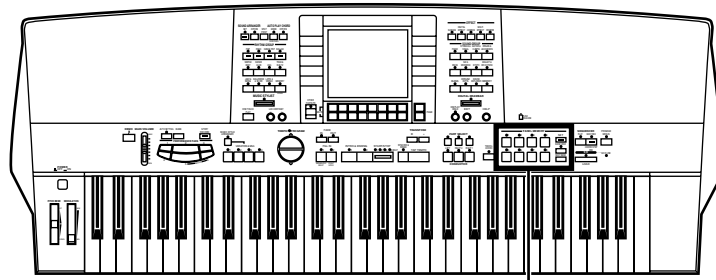

2·3

1 Set up the desired panel settings (sounds, volumes, etc.)

2 Use the **NEXT BANK** button to select a bank (A, B, C).

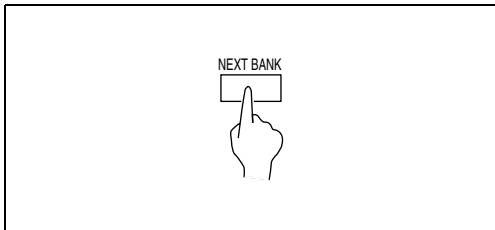

- The bank numbers are shown on the display.

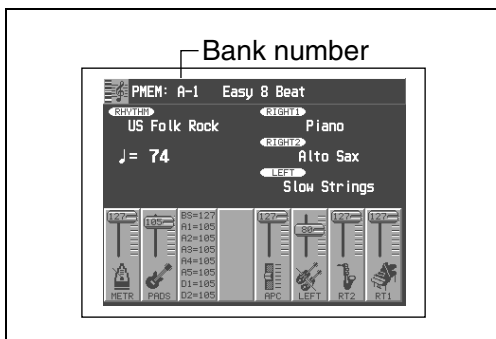

3 With the **SET** button held down, press one of the numbered buttons of the **PANEL MEMORY** (1 to 8).

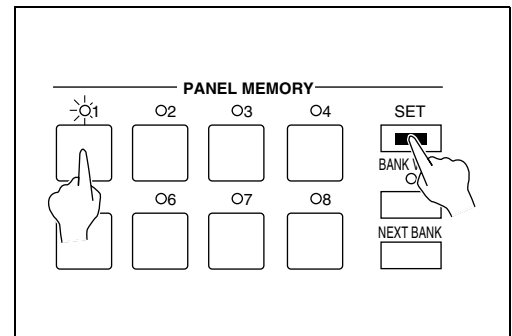

- The current panel settings are now stored in the specified bank and number. When you select the same bank and number again, the stored panel settings are recalled.

- If you do not wish to recall the rhythm, tempo, etc. with the **PANEL MEMORY**, press and hold the **SET** button for a few seconds to show the **PANEL MEMORY MODE** display, and select **NORMAL**.

Record your performance

(SEQUENCER)

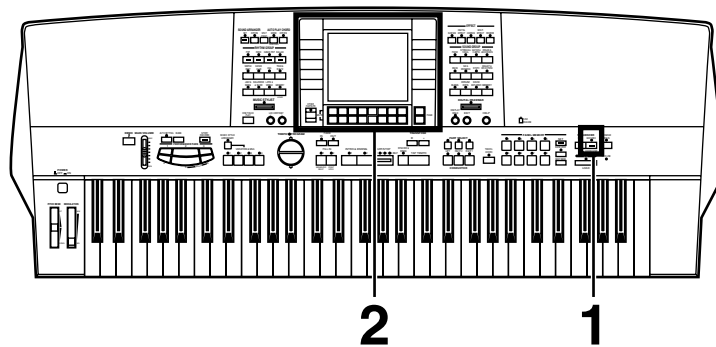

Sonatina

Sound: Piano (**RIGHT 1** part)

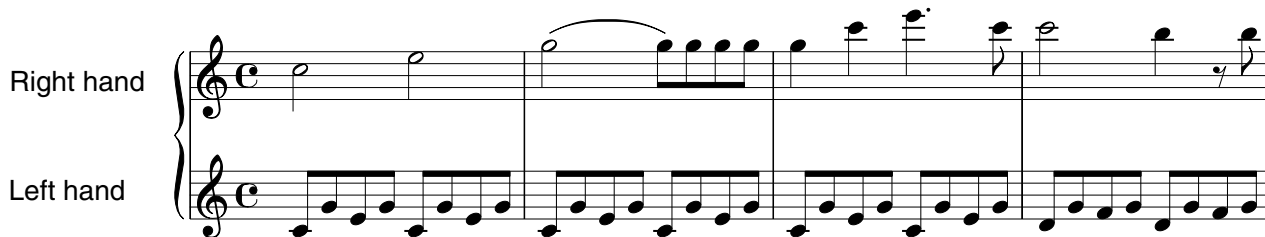

1 In the **SEQUENCER** section, press the **EASY REC** button to turn it on.

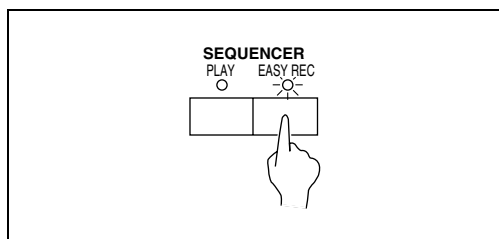

2 Press the OK button.

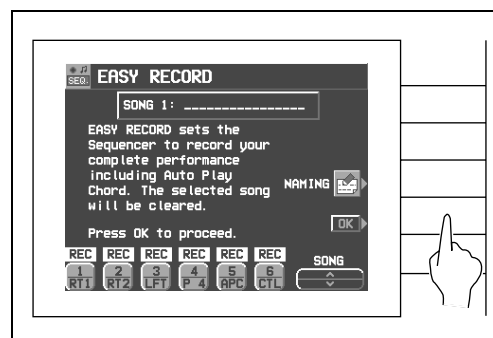

- The display changes to the **REALTIME RECORD** display.

(Continued on the next page)

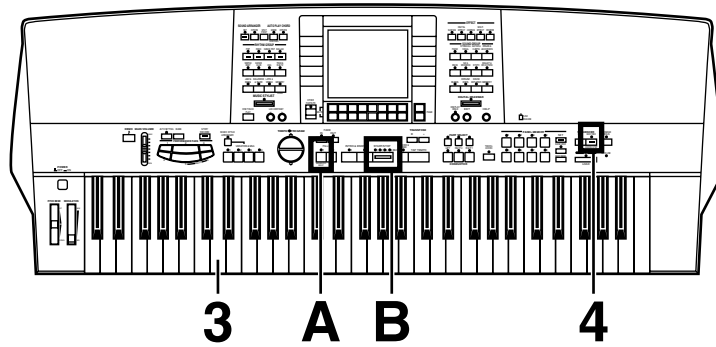

3 | Play the song on the keyboard.

4 | When you have finished playing, press the **EASY REC** button again to turn it off.

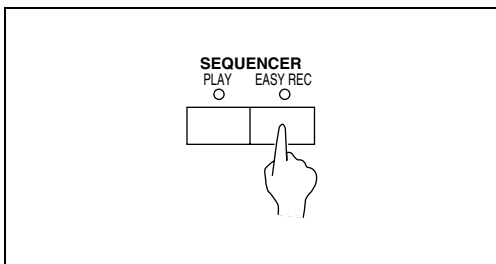

- The **PLAY** button in the **SEQUENCER** section turns on.

Playing back your recorded performance

A | Press the **SEQUENCER RESET (FILL IN 1)** button.

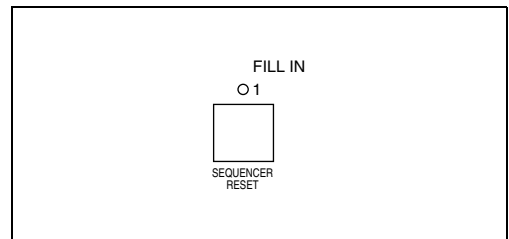

B | Press the **START/STOP** button.

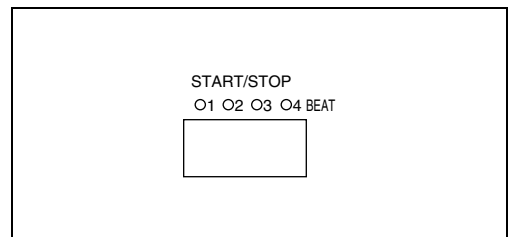

- Your performance is played back just as you recorded it.
- When you are finished playing back your performance, press the **PLAY** button in the **SEQUENCER** section to turn it off.

Save data on an SD card (KN2600)

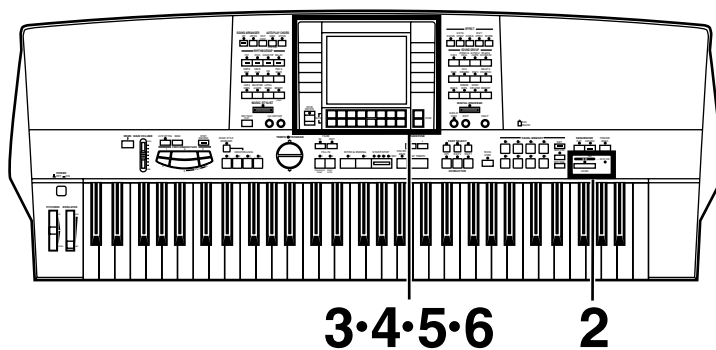

3·4·5·6

2

1 Insert an SD card you wish to save to into the SD slot. (Refer to page 19)

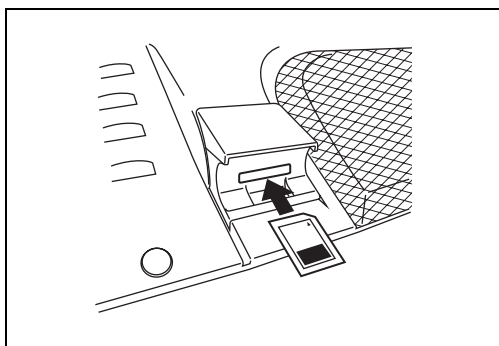

- Close the cover securely.

2 Press the SD button.

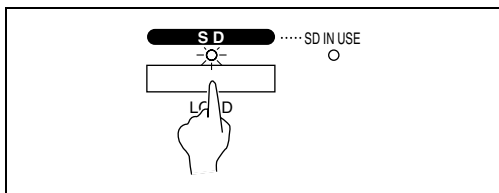

3 On the SD MENU display, select SAVE.

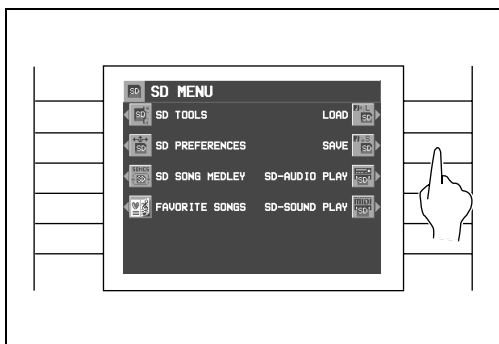

4 Select TECHNICS FORMAT.

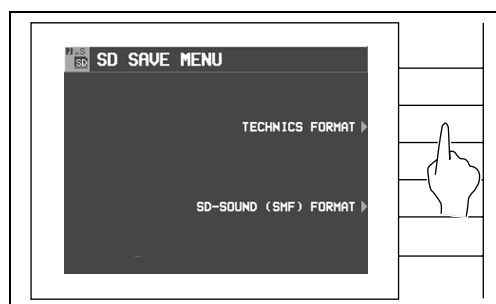

5 Specify the FOLDER and a SONG number to save to.

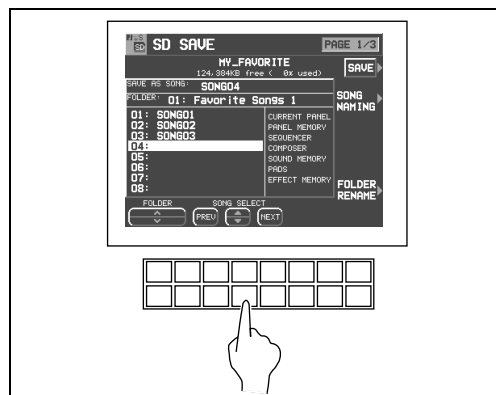

6 Press the SAVE button.

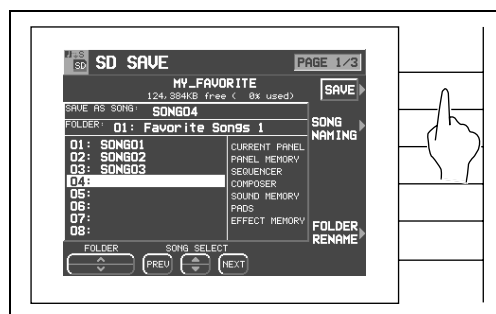

- The performance data of the song recorded in the **SEQUENCER** is saved on the SD card.

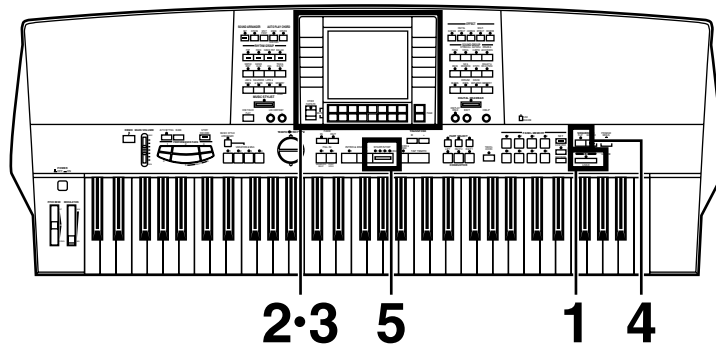

Recall data from an SD card

1 Press and hold the **SD** button for a few seconds.

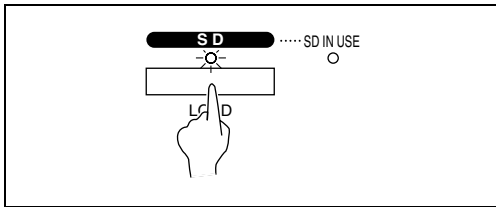

2 Select the **FOLDER** and the **SONG** you wish to load.

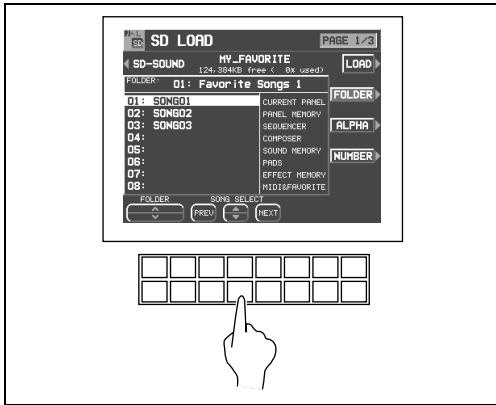

3 Press the **LOAD** button.
 • The data is copied to the internal memory of this instrument.

4 Press the **PLAY** button in the **SEQUENCER** section to turn it on.

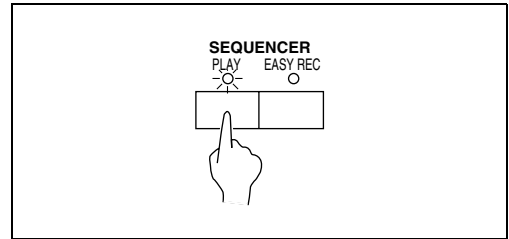

5 Press the **START/STOP** button.

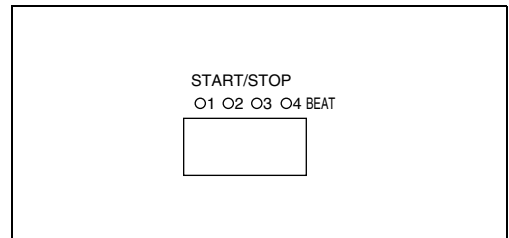

• The recalled song is played back.

■ The following data can be saved/loaded:

PERFORMANCE	CURRENT PANEL (The current panel settings)
	PANEL MEMORY
	SEQUENCER
	COMPOSER (MEMORY contents)
	SOUND MEMORY
	PERFORMANCE PADS (USER memories)
BACKUP	MIDI (USER memories for the MIDI PRESETS) & FAVORITES

• KN2400: The data can be saved in the disk.
 (Refer to page 125.)

Load rhythm data from a Technics pattern disk (COMPOSER LOAD) (KN2400)

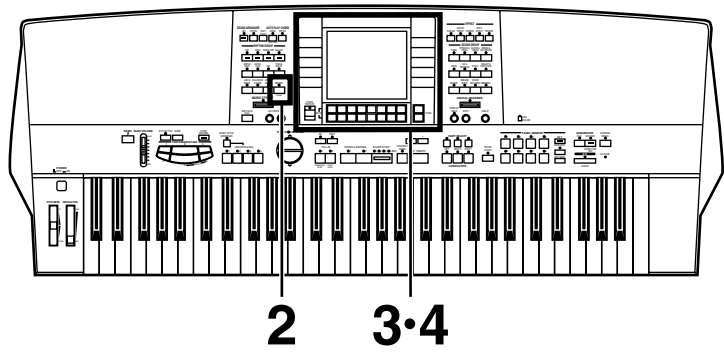

1 Insert a commercially sold Technics pattern disk into the Disk Drive slot.

2 In the **RHYTHM GROUP** section, press and hold the **LOAD (MEMORY)** button for a few seconds.

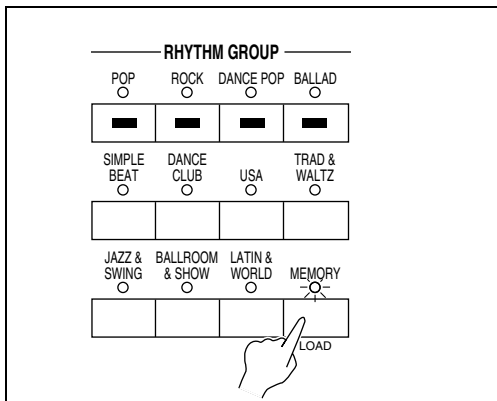

4 Press the **LOAD** button.

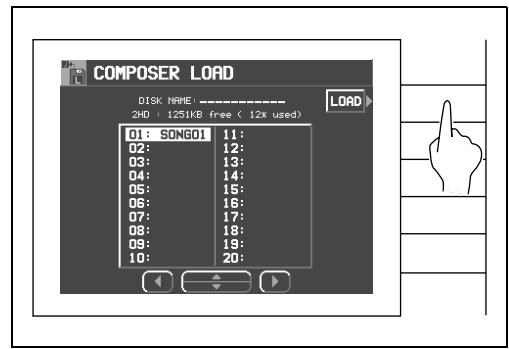

- Rhythm data is loaded to the **COMPOSER** memory (**MEMORY**). You can use the rhythms during your performance, just like the preset rhythms.

3 Select the name of the pattern to load.

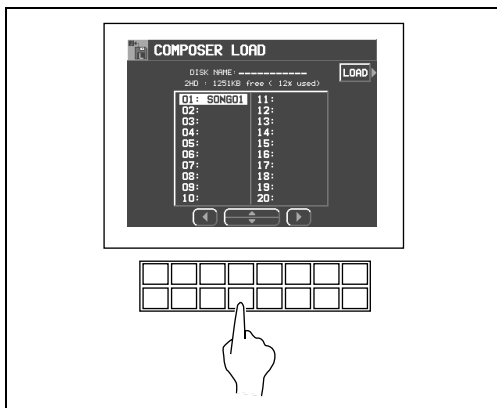

About the display

A large-size display, easy to operate with excellent readability, is used for displaying various information such as the names of the selected sounds and rhythms etc. and when setting the functions. Let's take a look.

- The display illustrations shown in this User's Manual are examples for the sake of clarification; the actual displays on your instrument may differ from the illustrations.

Normal display (HOME PAGE)

This is the kind of information you see on the display during a normal performance.

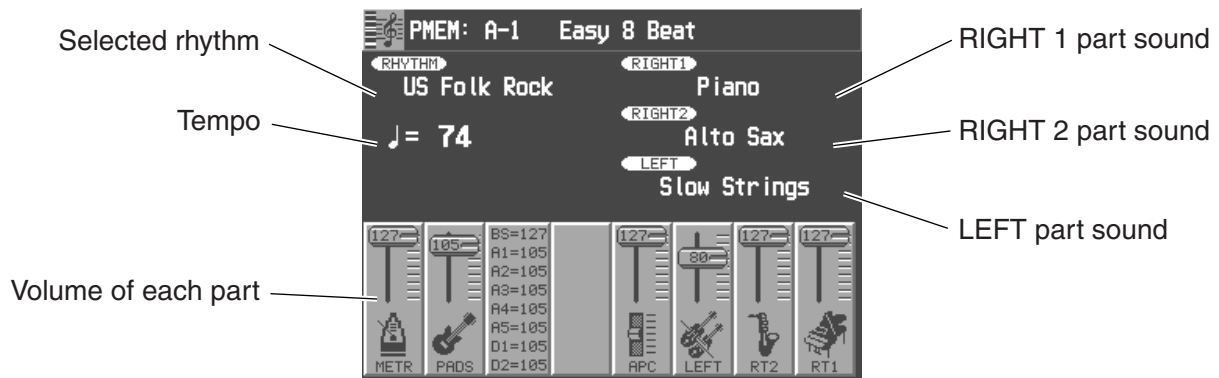

Volume balance

At the bottom half of the normal display, the volume balance of each part is represented in a fader illustration and by a number (0 to 127). You can use the balance buttons below the display to adjust the volumes.

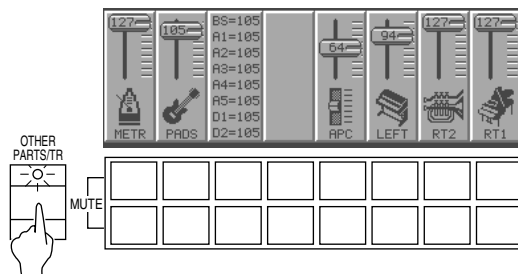

APC: AUTO PLAY CHORD PADS: PERFORMANCE PADS
METR: METRONOME

When setting the volume balance, press the upper button to increase the volume and the lower button to decrease it.

- Hold a button down to scroll the volume quickly.

<Auto accompaniment part>

Pressing the **OTHER PARTS/TR** button will display the auto accompaniment part setting screen.

- DRM: DRUMS APC: ACCOMP

■ MUSIC

“MUSIC” pertains to the SEQUENCER’s volume.

- Affects the sound of all parts except the keys.
- KN2600: does not affect SD-AUDIO data playback.

■ MUTE

To mute a part, press both the corresponding upper and lower buttons at the same time.

- The volume display for a muted part is shown as “MUTE.”
- Pressing either balance button for a muted part will cancel the mute function.

■ OTHER PARTS/TR

By the pressing the **OTHER PARTS/TR** button, the screen sequentially switches to the respective volume balance screens of the play part, auto accompaniment part, playback part (1 to 8), and playback part (9 to 16). The playback part

(PT) is used to playback recording and song data.

- When there are other parts or tracks to access, the **OTHER PARTS/TR** indicator is lit.

PAGE

When there are additional parts to the current display, a page number indication, for example PAGE1/2, appears in the upper right corner of the screen. For example, 1/2 indicates that there are two pages of the display, and the current page is page 1. In this case, you can use the upper and lower **PAGE** buttons, to the right of the balance buttons, to view different “pages” of the display.

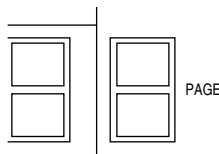

- Press the upper button to view the next page of the display, and the lower button to view the previous page of the display.
- On the last page of the display, pressing the upper button returns to the first page. And conversely, on the first page of the display, pressing the lower button will skip to the last page.

Menu display

The **PROGRAM MENU** button controls multiple functions. Press the button to access its menu display.



■ Example of menu display: PROGRAM MENU

Select a function from the menu display by pressing the corresponding button to the left or right of the display indicated by the ◀ and ▶ arrows.

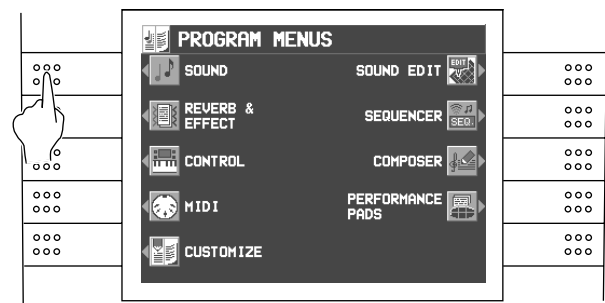

- In this manual, the steps describing how to select a function from a menu display are generally abbreviated as follows, for example: “On the PROGRAM MENU display, select SOUND.”

Setting display

When you select an item from the menu display, the setting display for the item is shown.

The buttons to the right, left and/or directly below the display are used to select and adjust the settings.

■ Example of setting display: MASTER TUNING

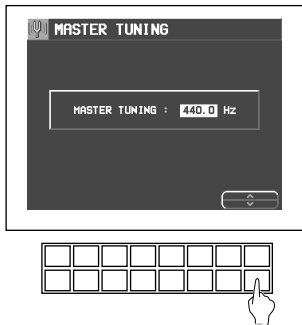

Press the button corresponding to the \wedge or \vee button on the display to change the value.

- In this manual, this procedure is written as follows: “Use the \wedge and \vee buttons to adjust the pitch.”

TEMPO/PROGRAM

If the **TEMPO/PROGRAM** indicator is lit while you are using the display to adjust the setting, it indicates that these buttons can be used to quickly change the displayed value or setting.

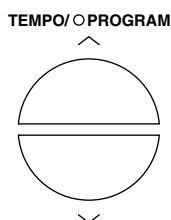

- The setting which can be adjusted is highlighted on the display.

EXIT

While the setting display is shown, press this button to go back to the previous display.

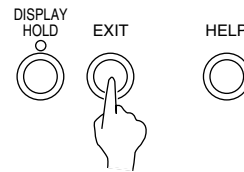

DISPLAY HOLD

Press this button to turn it on when you wish to maintain the current display. You can keep a display which is normally automatically canceled, for example, or even during a performance, you can monitor information which is not shown on the normal display.

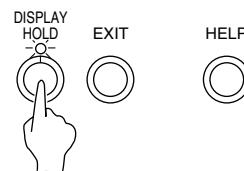

- The indicator for this button may flash if the current display is one which is normally automatically canceled.
- If the **PROGRAM MENU** button, for example, is pressed, the **DISPLAY HOLD** mode is canceled.

CONTRAST

Press the **CONTRAST** button and adjust the display's viewability using the \wedge and \vee buttons on the screen.



- When adjusting the **CONTRAST**, the set value is shown shortly on the display.

HELP

You can find an explanation of each button's function on the display.

1. Press the **HELP** button.

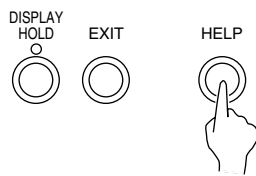

- The following display appears.

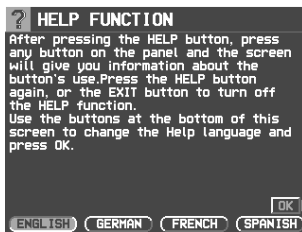

2. Use the buttons below the display to select a language.
3. Press the OK button.
4. Press a button on the panel whose explanation you wish to read.

- An explanation of the button's function is shown on the display.
5. Press the **HELP** button again to exit the help mode.
- Attention display messages and error messages are also shown in the selected language.
 - The appearance of the display on your instrument may be different from the illustrated display in this manual depending on the region in which your instrument was purchased and the selected display language.

Favorites

With up to 9 types of sounds, rhythms, functions, etc., you can arrange them to make up your own unique screen pattern.

1. Press the **FAVORITES** button to turn it on.



- The display looks similar to the following.



2. Press the **FAVORITES SETTING** button.

- The display looks similar to the following.



3. Select the desired item.
- Use the CATEGORY \wedge and \vee buttons to specify a category, and then the ITEM \wedge and \vee buttons to select an item.
 - The MUTE KEYS function silences the sound of the keyboard keys. This is convenient when you wish to pretend to play the keyboard while playing back a recorded performance.
 - The PANIC function interrupts the sound, for example, when it fails to cease during a MIDI performance.

(Continued on the next page)

4. While pressing the SET button, specify where you wish to paste (put) the item.
 - While the SET button is depressed, the display appears as shown below. Use the buttons to the left and right of the display to specify where you wish to paste the item.



5. Repeat steps 3 and 4 to create the display you want.
 - There are nine settable items on the display.
6. On the FAVORITES SETTINGS display, press the OK button.
 - Your customized display is stored.

■ Recall a FAVORITES display

1. Press the **FAVORITES** button to turn it on.
2. Use the buttons to the left and right of the display to specify the ITEM you wish to recall.
 - The **FAVORITES** settings can be saved to a disk/card.

Part I Sounds and effects

Overview of sounds and effects

The following is an overview of the sound parts of this instrument.

NX SOUND

NX SOUND is the Technics original sound generator format which evokes realtime performance quality and expressive power, and dramatically expands the number of sounds and effects generated. This format includes GM2 (General MIDI Level 2), and make various controls possible when data is created and reproduced by computer.

- For information about GM2, refer to page 118.
- Equipment with the logo shown below is compatible with NX SOUND song data.



Part

This instrument is organized into the following parts.

RIGHT 1, RIGHT 2, LEFT:

These are the parts the performer plays on the keyboard.

- These are independent from the playback parts. For example one can to perform on the keyboard while playing back a song disk with 16-part standard MIDI files (SMF).

PART1 to 16:

SMF song disk playback parts, or parts for MIDI receive.

ACCOMP1 to 5, BASS, DRUMS 1, 2:

Parts for the automatic accompaniment.

PADS:

Parts for the PERFORMANCE PADS

Selecting sounds

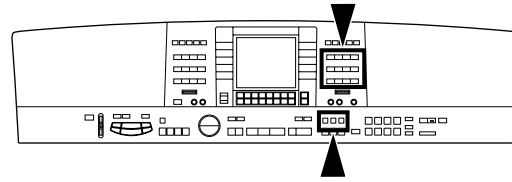

Select the sounds for the three parts you can play on the keyboard—**RIGHT 1**, **RIGHT 2** and **LEFT**. After first selecting a part and a **SOUND GROUP**, choose the desired sound from the display.

Select a sound

1. In the **PART SELECT** section, choose **RIGHT 1**, **RIGHT 2** or **LEFT**.

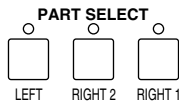

- The **CONDUCTOR** buttons are used to specify which part is heard. (Refer to page 39.)
- For the **RIGHT 1** and **RIGHT 2** parts, when a **CONDUCTOR** button is selected, the corresponding **PART SELECT** button is also activated.

2. In the **SOUND GROUP** section, select a sound group.

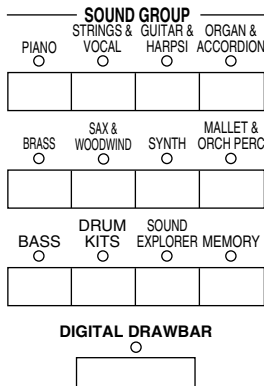

- The sounds in **DRUM KITS** are percussion sounds that you play by striking the keyboard keys.
- **MEMORY** is reserved for storing sounds you modify. (Refer to page 170.)

3. Select the desired sound from the list on the display.



- When you select a sound, the optimum effects for the sound are automatically applied. You can also choose to cancel this automatic feature. (Refer to page 153.)
- You can use the **PAGE** buttons to view a different page of the list.
- Use the **OCTAVE** \wedge and \vee buttons to select the octave.
- The sound you select is memorized for the part you selected in step 1.
- The sounds that can be selected for the **RIGHT 1**, **RIGHT 2** and **LEFT** parts and for **PART 1-16** vary.
- The illustrated display shows one example, and the actual display may be different.

4. Play the keyboard.
 • This instrument features **INITIAL TOUCH** (the volume, for example, changes depending on how hard the keyboard is played).

Sounds and effects

SOUND EXPLORER

This is a convenient feature for finding the sound you want from the many available sounds.

1. In the **PART SELECT** section, choose **RIGHT 1**, **RIGHT 2** or **LEFT**.
2. Press the **SOUND EXPLORER** button to turn it on..



3. Use the **GRP** \wedge and \vee buttons to select a **GROUP** of sound.
4. Use the buttons on both side of the display to select the sound.
 - The numerical value that is displayed for each sound is the MIDI [BANK MSB, LSB]-PROGRAM CHANGE number.
 - GM2 sounds are selected on this display.

■ ALPHABET

Press the **CTG** button to show the sound names in alphabetical order.

- Press the **ALP** button to return to the **CATEGORY** display.

Sounds and effects

Digital Drawbar

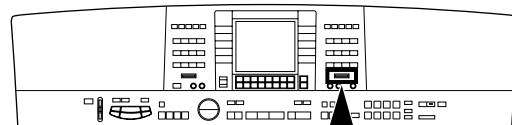

You can play organ sounds while controlling the drawbars on the display.

1. In the **PART SELECT** section, select a part.
2. Press the **DIGITAL DRAWBAR** button to turn it on.

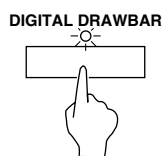

- The display looks similar to the following.

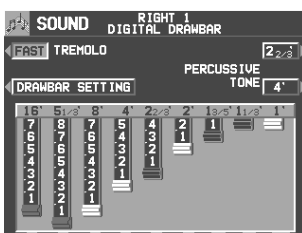

corresponding balance buttons to adjust the volume.

- The **DIGITAL DRAWBAR** can not be selected for the **ACCOMP** and **BASS** parts of the **COMPOSER**, **SOUND ARRANGER** or **PERFORMANCE PADS**.

<DRAWBAR SETTING>

Press the **DRAWBAR SETTING** button.



(Continued on the next page)

3. Use the balance buttons below the display to adjust the volume of each drawbar.
 - The volume of each drawbar is illustrated on the display and changes when you press the

■ **Change the sound type**

Use the <Jazz Drawbars> / <Rock Drawbars> button to select the type of sound.

■ **PERCUSSIVE TONE**

PERCUSSIVE TONE adds a tone with a fast initial attack to the drawbar sounds. You can select two pitch levels of attack tones.

Use the PERCUSSIVE TONE 2 2/3' and 4' buttons to turn the respective tone on or off.

■ **TREMOLO**

Tremolo is a rapid oscillation in volume, like the effect of a rotating speaker. The tremolo speed can be changed while you are playing.

Use the TREMOLO button to switch between the SLOW and FAST rotating speeds.

- The tremolo setting is effective for each part in common.
- The TREMOLO is disabled if the **MULTI EFFECT** button is turned ON.

■ **Other settings**

Use the buttons on either side of the display to select a setting item, and use one of the ^ and v buttons, whichever is relevant for the selection, and set.



ATTACK TIME:

Use the ^ and v buttons to adjust the time it takes for the drawbar sound to sound after a key is played.

RELEASE TIME:

Use the ^ and v buttons to adjust the time it takes for the drawbar sound to die out after the keys are released.

DECAY:

Use the ^ and v buttons to adjust the time it takes for the percussive tone to die out.

LEVEL:

Use the ^ and v buttons to adjust the volume of the percussive tone.

- The above settings are effective for the **RIGHT 1**, **RIGHT 2** and **LEFT** parts in common.

About foot marks

The foot indication (for example 8') refers to the pitch of a rank of pipes in a pipe organ. If 8' is used as the standard (the pitch as played on the keyboard), a 16' rank pitch will be one octave below the 8' rank pitch, and a 4' rank pitch one octave above.

When the C³ key is pressed, the sounds of the different pitch ranks are as follows.

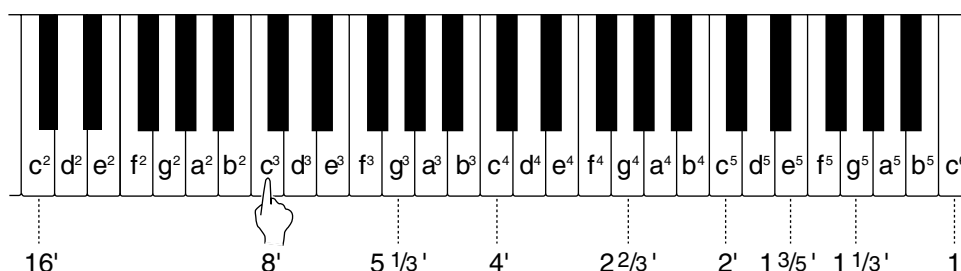

Assigning parts to the keyboard

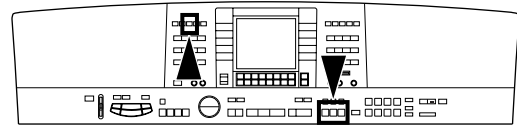

The **CONDUCTOR** buttons are used to assign the parts (**RIGHT 1**, **RIGHT 2**, **LEFT**) to the keyboard in many different ways. For example, you can split the keyboard into right and left sections (**SPLIT**), and assign a different sound to each section.

CONDUCTOR

CONDUCTOR settings	How sounds are assigned to the keyboard	
<p>CONDUCTOR</p>	All keys produce the RIGHT 1 sound.	
<p>CONDUCTOR</p>	All keys produce the RIGHT 2 sound.	
<p>CONDUCTOR</p>	All keys produce both the RIGHT 1 sound and the RIGHT 2 sound.	
<p>CONDUCTOR</p>	LEFT	RIGHT 1 + RIGHT 2
<p>CONDUCTOR</p>	LEFT	RIGHT 1
<p>CONDUCTOR</p>	LEFT	RIGHT 2

- The volume for each part can be adjusted independently. (Refer to page 30.)
- The following conditions are in effect when the **AUTO PLAY CHORD** is used.
 - BASIC, ADVANCED mode: You cannot assign sounds to all the keys.
 - PIANIST mode: The keyboard cannot be split.

SPLIT POINT

When the keyboard is split into left and right sections, the split point is usually C3.

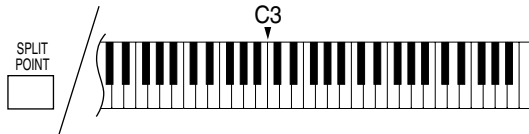

■ Customized split point

Use the following procedure if you wish to store a split point at a location other than C3.

1. Press the **SPLIT POINT** button.



- The following display appears.



2. Press a key on the keyboard to specify the desired split point.
 - A split point is set at the location of the pressed key, and is indicated on the keyboard illustration on the display.
 - The key at the split point is the lowest note of the right keyboard section.
 - After a few seconds, the display exits the setting mode.

Effects

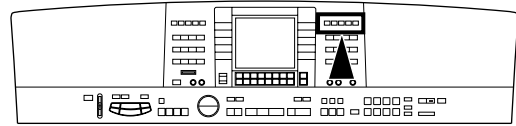

SUSTAIN

SUSTAIN is the gradual fading out of musical tones after the key is released.

1. In the **CONDUCTOR** or **PART SELECT** section, turn on the part to which this effect will be applied.
2. Press the **SUSTAIN** button to turn it on.



- The **SUSTAIN** can be set to on or off for each part.
- This effect does not work for the sounds in the **DRUM KITS** sound group.
- This effect may not work for some sounds.
- In the initialized state, the sustain can be turned on and off with the optional Foot Switch (sold separately).

DIGITAL EFFECT

DIGITAL EFFECT gives the sound richness and enhances your performance.

1. In the **CONDUCTOR** or **PART SELECT** section, turn on the part to which this effect will be applied.
2. Press the **DIGITAL EFFECT** button to turn it on.



- The on or off status of the **DIGITAL EFFECT** is preset for each sound.
- This effect does not work for the sounds in the **DRUM KITS** sound groups.
- This effect may not work for some sounds.

MULTI EFFECT

The **MULTI EFFECT** works like a studio effects processor, providing effects such as CHORUS, PHASER, DELAY and DISTORTION.

1. In the **CONDUCTOR** or **PART SELECT** section, turn on the part to which this effect will be applied.
2. Press the **MULTI EFFECT** button to turn it on.



■ Type and parameter settings

1. Press and hold the **MULTI EFFECT** button for a few seconds.
- The display changes to the following.

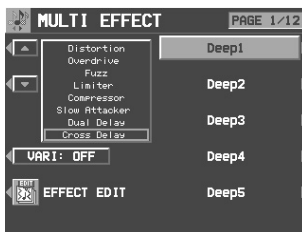

2. Use the ▲ and ▼ buttons to select an effect group.
 - The EFFECT MEMORY is for edited effects (see below).
3. Use the buttons to the right of the display to select the type.
 - If the types comprise more than one display “page,” use the **PAGE** buttons to switch pages.
 - Press the VARI button to enable the variation effect.
 - This display can also be accessed from the REVERB & EFFECT MENU display. (Refer to page 155.)

■ EFFECT EDIT

The effects can be edited and then stored in a memory.

1. Select an effect type to use as a base.
2. Press the EDIT button.
 - The display changes to the following.

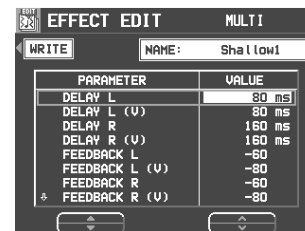

3. Use the PARAMETER ▲ and ▼ buttons to select the parameter.
4. Use the VALUE ^ and v buttons to adjust the setting.
 - The parameters vary depending on the effect type selected as the base.
 - (V) is the abbreviation of VARIATION.
5. Press the WRITE button.

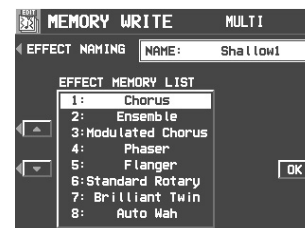

6. Press the EFFECT NAMING button and assign a name to the effect, if necessary.
 - Refer to page 65 for details about the NAMING procedure.
7. Use the EFFECT MEMORY ▲ and ▼ buttons to specify the location in which to store the edited effect.
8. Press the OK button.

REVERB

REVERB applies a reverberation effect to the sound.

Press the **REVERB** button to turn it on.



■ Type and parameter settings

1. Press and hold the **REVERB** button for a few seconds.
- The display changes to the following.

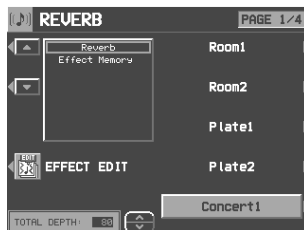

2. Use the ▲ and ▼ buttons to select an effect group.
 - The EFFECT MEMORY is an edited effect group.
3. Use the buttons to the right of the display to select a type.
 - If the types comprise more than one display “page,” use the **PAGE** buttons to switch pages.
4. Use the TOTAL DEPTH ^ and v buttons to set the depth of the effect.

- This display can also be accessed from the REVERB & EFFECT MENU display. (Refer to page 155.)

■ EFFECT EDIT

Your edited effect can be stored in a memory for later recall.

- The procedure is the same as for **MULTI EFFECT**. (Refer to page 42.)

CHORUS

Add breadth to the sound.

Press the **CHORUS** button to turn it on.



■ Type and parameter settings

1. Press and hold the **CHORUS** button for a few seconds.
- The display looks similar to the following.

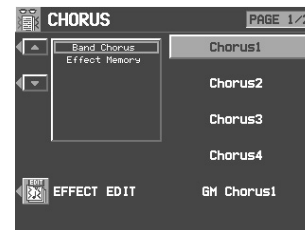

2. Use the ▲ and ▼ buttons to select the name of the effect group.
 - EFFECT MEMORY is an edited effect group.
3. Use the buttons to the right of the display to select a type.

■ EFFECT EDIT

Your edited effect can be stored in a memory for later recall.

- The procedure is the same as for **MULTI EFFECT**. (Refer to page 42.)

MIC

You can add reverb and other effects to sound from a connected microphone.

- Connect a microphone to this instrument. (Refer to page 188.)

1. Set the **PROGRAM MENUS** button to ON.



- The display will appear as follows:

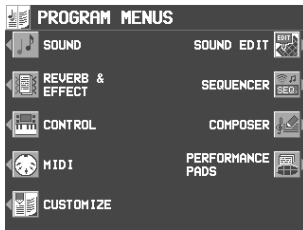

2. Select **REVERB & EFFECT**.

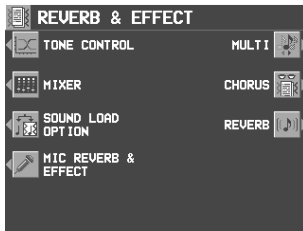

3. Select **MIC REVERB & EFFECT**.
- The display looks similar to the following.

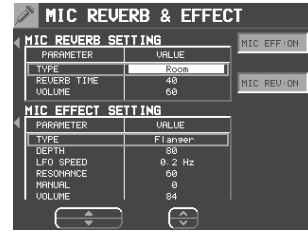

4. Set using the button on the left of the display. Select the effect name (**MIC REVERB/MIC EFFECT**).

5. Set the **MIC REVERB**.

- Use the **PARAMETER ▲** and **▼** buttons to select an attribute, and use the **VALUE ^** and **∨** buttons to adjust the corresponding setting.
- You can specify whether or not to apply the reverb with the **MIC REV ON/OFF** button.

6. Set **MIC EFFECT**.

- Use the **PARAMETER ▲** and **▼** buttons to select an attribute, and use the **VALUE ^** and **∨** buttons to adjust the corresponding setting.
- Enable or disable the effect using the **MIC EFF ON/OFF** button.

Controller

Use the controllers (left next to the keyboard) to change the nuance of the sound while you are playing.

PITCH BEND

The pitch of the instrument can be continuously changed with the **PITCH BEND** wheel at the left end of the keyboard. Using this control, you can produce the effect of bending the strings on a guitar.

While pressing a key on the keyboard, move the wheel up and down to control the pitch.

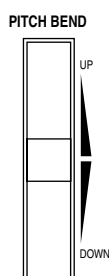

- When you release your hand from the wheel, it returns automatically to the center position and the pitch bend effect is turned off.
- The pitch bend effect does not function for the **AUTO PLAY CHORD** accompaniment pattern or during a normal performance for the sounds of the **LEFT** part.
- The amount of pitch bend can be set. (Refer to page 149.)

MODULATION (KN2600)

The **MODULATION** wheel is used to apply a vibrato effect, for example, to the sound.

While pressing a key on the keyboard, move the wheel up to add the effect.

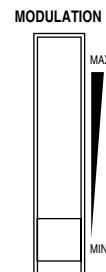

- When this effect is not needed, set the **MODULATION** wheel to the **MIN** position.
- This effect differs depending on the selected sound.
- The vibrato effect does not function for the **AUTO PLAY CHORD** accompaniment pattern or during a normal performance for the sounds of the **LEFT** part.

Transpose

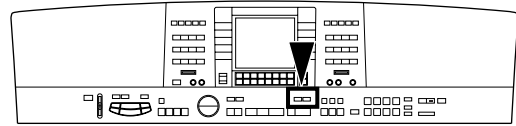

The **TRANPOSE** buttons are used to change the key of the entire instrument in semi-tone steps across an entire octave.

Suppose you learn to play a song—in the key of C, for example—and decide you want to sing it, only to find that it's either too high or too low for your voice. Your choice is to either learn the song all over again in a different key, or to use the **TRANPOSE** feature.

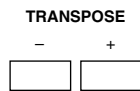

Adjust the key with the + and – buttons.

- The key is changed in half-tone increments up to plus or minus one octave.
- If the two buttons are pressed at the same time, the key returns to C.
- When the **TRANPOSE** function is active, the transposed key is shown on the HOME PAGE display.

<Example: transposed to D>

Played keys

C major

Notes that sound

D major

Techni-chord

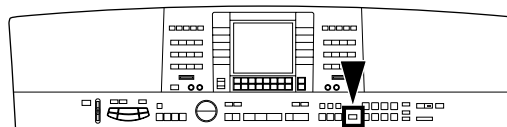

TECHNI-CHORD turns your single note melodies into full chords and offers you a choice of different types from a simple duet which adds one harmony note to your melody note, to big band reeds which adds four harmony notes to your melody note. If **TECHNI-CHORD** is part of a **ONE TOUCH PLAY** or **MUSIC STYLIST** registration, a suitable **TECHNI-CHORD** type will be selected automatically.

Example:

Left hand (chord)

Right hand (melody)



1. Split the keyboard into left and right sections.
2. Press the **TECHNI-CHORD** button to turn it on.



3. Play the keyboard.
 - The melody you play with your right hand is automatically played in chords which are based on the chords you play with your left hand.
 - This feature is very effective when used with the **AUTO PLAY CHORD**.

Type setting

1. Press and hold the **TECHNI-CHORD** button for a few seconds.
 - The display looks similar to the following.

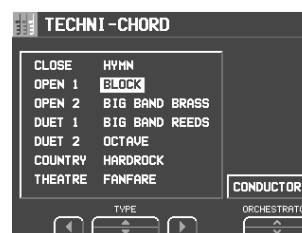

2. Use the ◀, ▲, ▼, ▶ buttons to select the harmony style.
 - When the **OCTAVE**, **HARD ROCK** or **FANFARE** style is selected, the **TECHNI-CHORD** functions even when the keyboard is not split.

■ ORCHESTRATOR

You can specify which part is used for the harmony tones. Your **TECHNI-CHORD** performance is enhanced by selecting harmony sounds different from the sounds you play and the sounds produced by the automatic accompaniment.

1. Use the **ORCHESTRATOR** ^ and v buttons to select the part for the harmony notes.
 - If **CONDUCTOR** is selected, the harmony notes are produced in the sounds of the part which is currently selected in the **CONDUCTOR (RIGHT 1, RIGHT 2)**. In other words, the harmony notes are produced in the same sound as the melody notes. If both **RIGHT 1** and **RIGHT 2** are on, the harmony notes are produced in the sound of the **RIGHT 1** part.

- In the case of **EASY RECORD** (see page 77), when set to **CONDUCTOR** or a part other than **PART 4**, the **TECHNI-CHORD** sound is not recorded; so when you use **EASY RECORD**, please set to one or the other.

Part II Playing the rhythm

Overview of rhythm performance

An explanation follows of the terms related to this instrument's rhythm performance.

Rhythm and accompaniment pattern

Each rhythm is comprised of not only a **DRUMS** pattern, but also of accompaniment patterns called **BASS** and **ACCOMP**. The combination of all of these is the rhythm.

- The accompaniment pattern sounds when you perform using the **AUTO PLAY CHORD (APC)**. (Refer to page 52.).

Rhythm and Style

One rhythm of this instrument is comprised of four **VARIATION** patterns, and for each one the optimum sounds and effects are set.

All of these together comprise one **STYLE**.

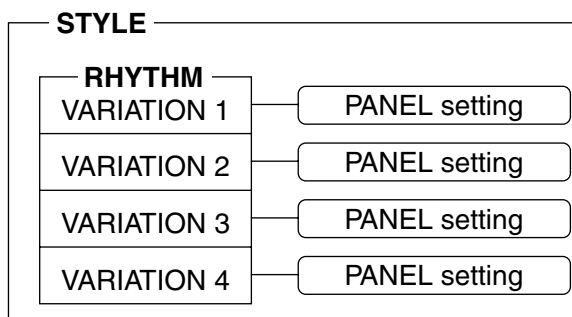

- In the **MUSIC STYLIST** (page 60) and **MUSIC STYLE ARRANGER** (page 62) etc. this **STYLE** is summoned.

Selecting rhythms

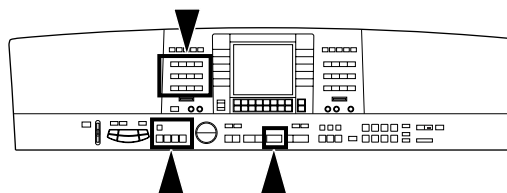

Many exciting rhythms are stored in the memory of this instrument. First select one of the rhythm groups and then choose the desired rhythm.

Select a rhythm

1. In the **RHYTHM GROUP** section, select a rhythm group.

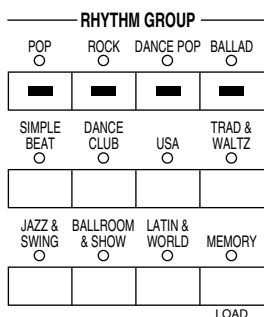

- **MEMORY** is the group in which you store the rhythms you create with the **COMPOSER**. (Refer to page 111.)
2. Select the desired rhythm from the list on the display.

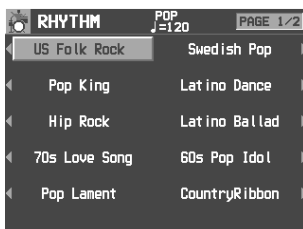

- If there is more than one page to the display, use the **PAGE** buttons to move from one screen page to another.

■ VARIATION

There are four variations available for each rhythm. Use the **VARIATION** buttons to select the desired variation.

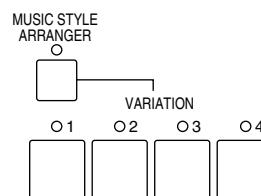

- Confirm that the **MUSIC STYLE ARRANGER** button is off. (If it is on, press it once to turn it off.)
- The nuance of the pattern differs with each variation number.
- You can change to a different variation while the rhythm is playing.

Start the rhythm

There are two ways to start the rhythm.

■ Normal start

1. Select a rhythm.
2. Press the **START/STOP** button to turn it on.

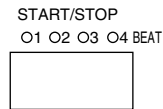

- The selected rhythm pattern immediately begins to play.
- You can stop the rhythm by pressing the **START/STOP** button again to turn it off.
- The **BEAT** indicators above the **START/STOP** button light to indicate the beat.

■ Synchronized start

With the synchronized start feature, the rhythm pattern starts when you play a key on the keyboard.

1. Select a rhythm.
2. Press the **SYNCHRO & BREAK** button to turn it on.

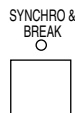

3. Play a key to the left of the keyboard split point.
 - The rhythm pattern begins to play.
 - You can use the synchronized start feature even when the keyboard is not divided into left and right sections. To start the rhythm, press a key to the left of the specified split point.

■ Adjust the tempo

The tempo of the rhythm pattern is adjusted with the **TEMPO/PROGRAM** buttons.

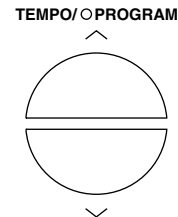

- The tempo is shown on the display as a numerical value (♩ = 40 to 300).
- When the **TEMPO/PROGRAM** indicator is lit, the **TEMPO/PROGRAM** cannot be used to adjust the tempo.
- To adjust the tempo during playback, refer to page 81.

■ TAP TEMPO

You can set the tempo of the rhythm by tapping this button few times with your finger at the tempo you wish to play.

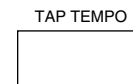

- The tempo at which the button is tapped is detected, and the tempo automatically changes correspondingly.

Playing the rhythm

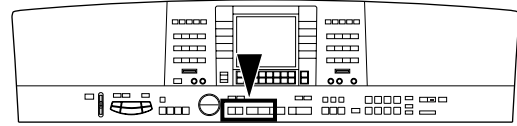

Intro, fill-in and ending patterns fitting each different rhythm pattern are permanently recorded in your Keyboard, thus allowing a versatile rhythm performance.

INTRO

Begin the rhythm performance with an intro pattern.

1. Press the **INTRO & ENDING 1** or **INTRO & ENDING 2** button to turn it on.

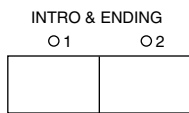

2. Press the **START/STOP** button to start the rhythm.

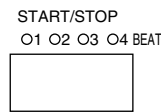

- An intro pattern is played, after which the normal rhythm pattern begins.

COUNT INTRO

You can begin the rhythm performance with a spoken one-measure count.

1. Press the **COUNT INTRO (FILL IN 2)** button to turn it on.

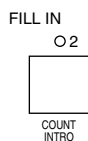

2. Press the **START/STOP** button to start the rhythm.

- A spoken one-measure count is played, after which the normal rhythm pattern begins.

Mode setting

You can select the mode for the count sound.

1. Press the **MODE** button in the **AUTO PLAY CHORD** section to turn it on.

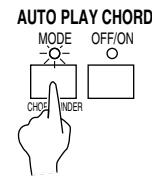

- The display looks similar to the following.

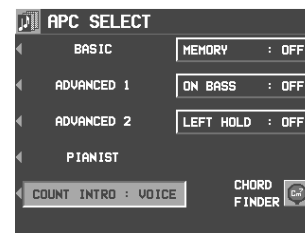

2. Use the **COUNT INTRO** button to select a mode.

VOICE: A spoken count (initialized setting).
CLICK: A clicking sound for the count.

FILL IN

You can insert a fill-in pattern any time during the rhythm performance. Choose from two different fill-in patterns.

1. Select a rhythm and press the **START/STOP** button.
2. Press the **FILL IN 1** or **FILL IN 2** button.

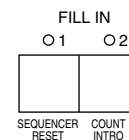

- A fill-in pattern is heard immediately for the remainder of the measure.
- When a **FILL IN** button is pressed on the last beat of the measure, the fill-in pattern continues to the end of the following measure.

ENDING

Finish the rhythm performance with an ending pattern.

1. Select a rhythm and press the **START/STOP** button.
2. Press the **INTRO & ENDING 1** or **INTRO & ENDING 2** button to turn it on.

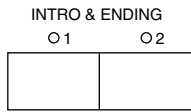

- An ending pattern is produced, and then the rhythm performance stops.
- If you accidentally press the **INTRO & ENDING** button in the middle of the tune, you can press the **FILL IN 1** or **FILL IN 2** button. The ending pattern stops, and a fill-in pattern is produced, after which the normal rhythm performance continues.

Auto Play Chord

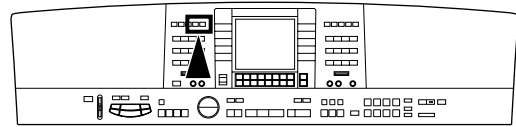

Simply by playing a chord on the keyboard, the **AUTO PLAY CHORD** function automatically plays an accompaniment pattern which matches perfectly the selected rhythm. With a real accompaniment as a background, you can concentrate on playing the melody.

How the AUTO PLAY CHORD works

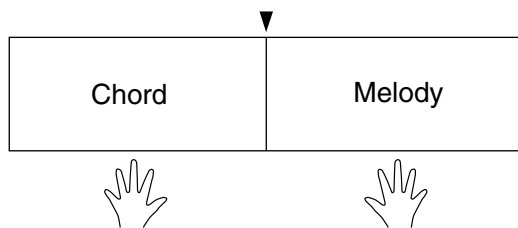

When an **AUTO PLAY CHORD** mode is selected, an automatic accompaniment which matches the rhythm you have chosen is played in the chord which you specify with your left hand. The melody is played with your right hand.

- The accompaniment pattern of the **AUTO PLAY CHORD** is composed of 8 parts: **DRUMS 1, 2, BASS, ACCOMP 1-5**.
- The volume of each part can be adjusted with the buttons below the display. (Refer to page 30.)

Playing chords

Choose from the 4 ways of playing chords.

■ BASIC mode

This mode lets beginners specify chords with just one finger. With this mode, chords can be specified either with one finger <one finger> or by pressing all of the chord's sound components <fingered>.

<one finger>

In the <one-finger>, a major chord can be played just by pressing the key for its root note.

Example: C chord



Minor, seventh and minor seventh chords are also easily produced.

minor chord	seventh chord	minor seventh chord
Play the root note plus a black key to the left of it.	Play the root note plus a white key to the left of it.	Play the root note plus a black key and a white key to the left of it.
Example: Cm 	Example: C7 	Example: Cm7

- When three or more keys of a chord are pressed, it is recognized as a <fingered> chord.

<fingered>

In the <fingered>, you specify the chord by playing all the notes in the chord.



- Play at least three notes to specify the chord.

■ ADVANCED 1 mode

This mode accepts chords specified with <fingered> and disregards all unrecognizable chord specifications.

- It recognizes many more chords than the BASIC mode's <fingered> chords.

■ ADVANCED 2 mode

This mode accepts chords specified with <fingered> and, for unrecognizable chords, it plays the auto accompaniment according to the keys pressed.

- It recognizes many more chords than the BASIC mode's <fingered> chords.

■ PIANIST mode

In the PIANIST mode, the entire keyboard can be used to specify chords <fingered> (ADVANCE) for the automatic accompaniment; a **RIGHT** part is assigned to all the keys, and the keyboard does not split.

- When specifying chords, if you press a key a perfect 5th or more below the lowest note of the chord, the **BASS** part becomes a pattern based on that note.

<APC HOLD>

If this function is assigned to the Foot Switch (sold separately), for example, pressing the Foot Switch will play the currently specified chord in that timing, allowing you to focus your performance on a solo melody.

- The accompaniment continues in the same chord as long as the Foot Switch is depressed, and it does not change even if other chords are played.
- To change the Foot Switch assignment, refer to page 172.

How to use the AUTO PLAY CHORD

1. Select the desired rhythm and sound(s), and set the tempo.
2. Press the **AUTO PLAY CHORD's OFF/ON** button to turn it on.

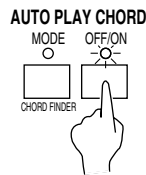

3. Press the **AUTO PLAY CHORD's MODE** button to turn it on.
 - The display looks similar to the following.

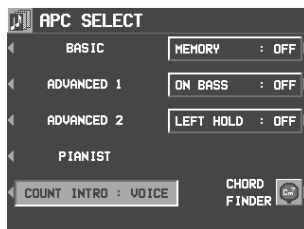

4. Select an **AUTO PLAY CHORD** mode .
 - After a few seconds, the display returns to the previous display.
 - If the **BASIC** or **ADVANCED** mode was selected, the keyboard automatically splits into right and left sections.
5. Press the **START/STOP** button to begin the rhythm.
 - You can start the rhythm by playing a key on the keyboard. (Refer to page 50.)
6. Specify a chord.
 - If the **BASIC** or **ADVANCED** mode was selected, specify the chord on the keyboard section to the left of the split point.
 - An accompaniment pattern in the specified chord is automatically played. Play the melody with your right hand.

- When you use **FILL IN**, **INTRO** and **ENDING**, the automatic accompaniment is also used in these patterns.
 - You can set the mode which determines how the **LEFT** part sounds during an **AUTO PLAY CHORD** performance. (Refer to the next page.)
 - In the initialized condition, when the rhythm is off, if an **AUTO PLAY CHORD** mode is on and a chord is specified, the specified root note (R. BASS part) and chord notes (CHORD part) are produced. The volumes of these notes can be adjusted. (Refer to page 30.)
7. To stop the automatic accompaniment, press the **START/STOP** button.
 - If you wish the automatic accompaniment to begin and end the performance, set the **OFF/ON** button to off.

■ MEMORY

Press the **MEMORY** button and select either one of the following:

- ON:** Even when removing your finger from the keys, the present chord is retained until the next chord is specified.
- OFF:** When removing your finger, the chord is deleted.
- AUTO:** The chord is retained when auto accompaniment is playing but is not retained when stopped.

■ ON BASS

If the **ON BASS** button is **ON**, the **BASS** part is produced in the key of the lowest note of the played chord, thus making it possible to play chords such as C on G.

- For example, with the **ON BASS** button on, if you play a C chord by pressing the keys G, C and E, the **BASS** part is produced in the key of G.

Example of how to play a BASIC <One-Finger> accompaniment

Play the melody with your right hand.

Left hand

Left Hold

This setting determines how the **LEFT** part sounds when the **LEFT** button in the **CONDUCTOR** is on during a performance with the **BASIC** or **ADVANCED** mode.

1. Press the **MODE** button to turn it on.
 - The display changes to the following.

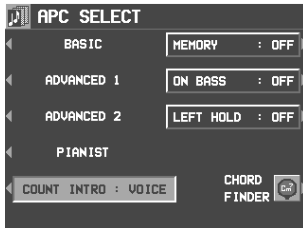

2. Use the **LEFT HOLD: ON/OFF** button to set the mode to on or off.

OFF:

The **LEFT** part sounds from the pressed chord keys.

- When **BASIC** is selected, the **LEFT** part turns off. The **LEFT** part sounds if you turn it on, but <one-finger> chords cannot be specified.

ON:

Specifying <one-finger> chords in the **BASIC** mode produces the full chords; otherwise the **LEFT** part notes are those of the pressed chord keys.

- When **BASIC** is selected the **LEFT** part turns off, but it will sound if you turn it on.
- Touch response does not function for the **LEFT** part.
- When the mode is set to **ON**, during a rhythm performance, the **LEFT** part continues to play even when the keys are released.

CHORD FINDER

The **CHORD FINDER** can help, for example, when you do not know which keys to press to specify a given chord. When you input the chord name, the **CHORD FINDER** shows you which keys to press and even lets you hear the notes that make up.

1. Press the **AUTO PLAY CHORD's MODE** button to turn it on.

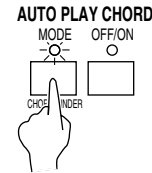

- The display changes to the following.



2. Select **CHORD FINDER**.

- The display changes to the following.

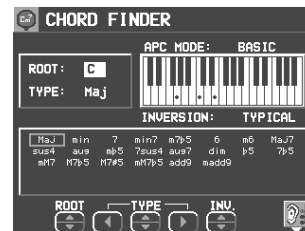

3. Use the **APC MODE** button to select the automatic accompaniment mode you will use to specify chords (**BASIC**, **ADVANCED 1**).
- In the list column are shown the chords which can be specified in each mode.

(Continued on the next page)

4. Use the ROOT buttons to select the root note of the chord. Use the TYPE buttons to select the type of chord.
 - A typical way to finger the specified chord (TYPICAL) is illustrated on a keyboard diagram.
 - Each time the INVERSION button is pressed, different INVERSION fingerings are illustrated in order. (If there is no INVERSION fingering for the specified chord, this button is not shown on the display.)
 - When the button with a picture of an ear is pressed, the notes of the chord sound. (The octave of the illustrated keys and that of the played tones may differ.)
5. To exit the CHORD FINDER procedure, press the **EXIT** button.

BREAK function

With the break function, the rhythm starts when the left keyboard is played and stops when the fingers are removed from the keys.

1. Select an **AUTO PLAY CHORD** mode.
 - At this time, the MEMORY (APC SELECT) button should be OFF.
2. Press the **SYNCHRO & BREAK** button to turn it on.

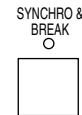

3. Specify a chord.
 - The automatic accompaniment begins to play (synchronized start).
 - For the PIANIST mode, play the keys to the left of the currently set split point.
4. Release the chord keys.
 - The automatic accompaniment stops. When the keys are pressed again, the rhythm starts from the first beat.

Fade In/Fade Out

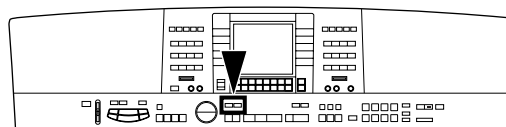

Add interest to your performance by starting a part with a fade-in or ending it with a fade-out.

- KN2600: does not work for the SD-AUDIO data playback.

FADE IN

At the beginning of the song, the volume of each part rises slowly.

1. Set up the panel settings for your performance.
2. Turn on the **FADE IN** button.

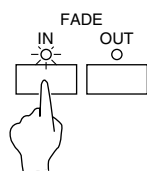

- The indicator flashes. In this condition, the volumes for all parts change to 0 and no sound is produced from this instrument until the **FADE IN** is turned off or until step 3 is executed.
3. Play the keyboard or press the **START/STOP** button.
 - The volume slowly builds to its preset level.
 - For the fade-in effect for a rhythm part or when playing back a **SEQUENCER** performance, turn on the **FADE IN** button before pressing the **START/STOP** button.
 - At the end of the fade-in, the **FADE IN** indicator goes out.
 - During the fade-in, FADE IN is shown in the upper right part of the normal display.

FADE OUT

At the end of the song, the volume of each part gradually fades to nothing.

1. Start the performance.
2. Turn on the **FADE OUT** button at the point you want the fade-out to start.

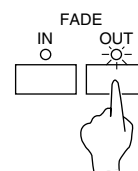

- The volumes of all the parts slowly fade to 0.
- The indicator flashes to show that fade-out is completed, and then goes out. The volumes for all parts return to their specified settings.
- If you wish to interrupt the fade-out, press the **FADE OUT** button to turn it off.

FADE SET

Adjust the settings for the FADE IN and FADE OUT.

1. Press and hold the **FADE IN** or **FADE OUT** button for a few seconds.

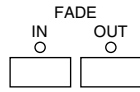

- The display looks similar to the following.

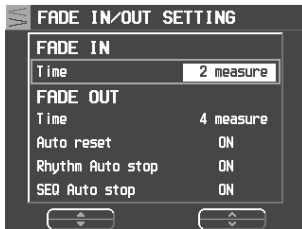

2. Use the ▲ and ▼ buttons to select the item. Use the ^ and v buttons to change the setting.

FADE IN

Time:

Specify the time elapsed between 0 volume to the set volume (1 measure to 16 measure).

FADE OUT

Time:

Specify the time elapsed between the set volume and 0 volume (1 measure to 16 measure).

Auto Reset:

Specify whether the volume of each part automatically returns to its specified setting (ON, OFF).

Rhythm Auto stop:

Specify whether the rhythm turns off after fade-out is completed (ON, OFF).

SEQ Auto stop:

Specify whether the **SEQUENCER** playback automatically stops after fade-out is completed (ON, OFF).

- The display returns to the previous display a few seconds after you have changed the settings.
- You can also access this display from the CONTROL MENU display. (Refer to page 171.)

Sound Arranger

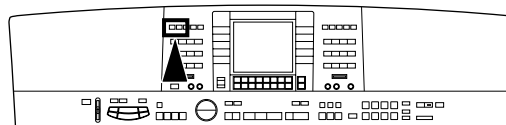

The **SOUND ARRANGER** feature lets you select other sounds for the **AUTO PLAY CHORD** parts of each rhythm.

1. Select the rhythm whose sound you wish to change.
 - Do not select the **MEMORY** button.
2. In the **SOUND ARRANGER**, press the **SET** button to turn it on.

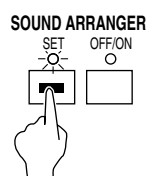

- The display looks similar to the following.

SOUND ARRANGER		
PATTERN : 8Bt Standard		
PART	SOUND	D. EFFECT
DRUMS1	Standard Kit1	---
DRUMS2	Standard Kit2	---
BASS	Electric Bass	OFF
ACCOMP1	Folk Guitar	OFF
ACCOMP2	Stereo Ac. Gtr	OFF
ACCOMP3	Modern E. P.	OFF
ACCOMP4	SymphonicStrings	OFF
ACCOMP5	Stereo Ac. Gtr	OFF

3. Use the **▲** and **▼** buttons to select the part whose sound you wish to change.
4. Select the desired sound.
 - The **DIGITAL EFFECT** on/off status can also be specified (except for **DRUMS** part).
 - For the **DRUMS** part, select sounds from the **DRUM KITS** group.
 - The sound and on/off status of the **DIGITAL EFFECT** are shown on the display.
 - The sounds marked with # cannot be changed.
5. Repeat steps 3 and 4 for the other parts as desired.
6. When you have finished selecting the sounds, press the **SET** button to turn it off.

Playing back the sounds

1. In the **SOUND ARRANGER**, press the **OFF/ON** button to turn it on.

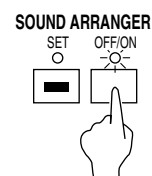

2. Start the rhythm (automatic accompaniment).
 - When the **OFF/ON** button is off, the factory-preset sounds are produced.
 - This setting can be set separately for each rhythm.
 - If you wish to modify the settings you specified, while the **OFF/ON** button is on, press the **SET** button to turn it on.

One Touch Play

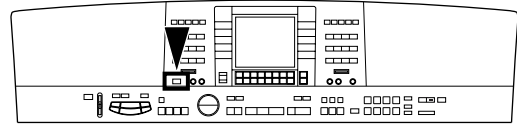

ONE TOUCH PLAY automatically sets a suggested combination of sounds and an appropriate tempo for your chosen rhythm style.

1. Select a rhythm pattern.
 - Do not select the **MEMORY** button.
2. Press and hold the **ONE TOUCH PLAY** button for a few seconds.
3. Play the keyboard.
 - When you specify a chord, the automatic rhythm begins to play immediately.



- During setting, the style name is shown on the display.
- The **AUTO PLAY CHORD** and the **SYNCHRO & BREAK** are automatically turned on, and the sounds and effects, volume balances, tempo etc. that are ideal for your selected rhythm are automatically set.

Playing the rhythm

Music Stylist

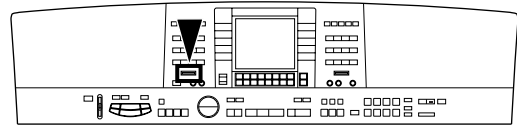

MUSIC STYLIST sets up your instrument with a suitable registration for a specific style of music or tune.

Setup by music style

Select a style from the **MUSICAL CATEGORY**.

1. Press the **MUSIC STYLIST** button to turn it on.
2. Select **MUSICAL CATEGORY**.
 - The display looks similar to the following.

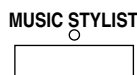

- The display looks similar to the following.

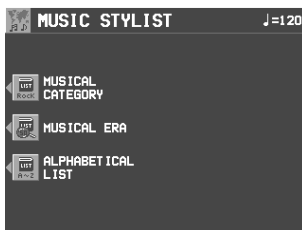

3. Use the **CATEGORY** ▲ and ▼ buttons to select a category.
4. Use the **STYLE** ▲ and ▼ buttons to select a music style.
 - During the search, you can use the **SKIP** ^ and v buttons to skip to the previous or following subcategory.

- The **AUTO PLAY CHORD** and the **SYNCHRO & BREAK** turn on, and the sounds, effects, volume balances, rhythm and tempo etc. which are best suited for the selected music style are automatically selected.
5. Play the keyboard.
- When you specify a chord, the automatic rhythm begins to play immediately.

Setup by era

You can select a style from a specific music era.

1. Press the **MUSIC STYLIST** button to turn it on.
2. Select MUSICAL ERA.
 - The display looks similar to the following.



3. Use the **STYLE ▲** and **▼** buttons to select a style.
 - You can use the **SKIP ^** and **∨** buttons to skip to the previous or following era.
 - You can use the **MORE** button to view the next page of styles.

- The **AUTO PLAY CHORD** and the **SYNCHRO & BREAK** turn on, and the sounds, effects, volume balances, rhythm and tempo etc. which are best suited for the selected style are automatically selected.
4. Play the keyboard.
- When you specify a chord, the automatic rhythm begins to play immediately.

Setup by alphabetical order

You can use alphabetical or numerical search to select a style name.

1. Press the **MUSIC STYLIST** button to turn it on.
2. Select ALPHABETICAL LIST.
 - The display looks similar to the following.



3. Use the **STYLE ▲** and **▼** buttons to select a style.

- You can use the **SKIP ^** and **∨** buttons to skip to the previous or following alphabetical or numerical heading.
 - You can use the **MORE** button to view the next page of styles.
 - The **AUTO PLAY CHORD** and the **SYNCHRO & BREAK** turn on, and the sounds, effects, volume balances, rhythm and tempo etc. which are best suited for the selected style are automatically selected.
4. Play the keyboard.
- When you specify a chord, the automatic rhythm begins to play immediately.

- On the MUSICAL CATEGORY, MUSICAL ERA, or ALPHABETICAL LIST (ALPHABET) display, you can move freely to each display using the buttons to the right of the display.
- After deciding on a style with the **MUSIC STYLIST**, if you record the settings in the **PANEL MEMORY**, the same style name is copied to the **PANEL MEMORY** (up to 16 characters). When you recall the **PANEL MEMORY** settings, this style name is shown at the top of the normal display.
- After selecting a style, turn the **MUSIC STYLIST** button off if you wish to have the normal display active during a performance.

Music Style Arranger

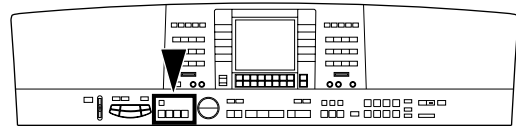

The **MUSIC STYLE ARRANGER** helps you to make professional registration changes during your performance. Select between four contrasting registrations at the push of a button, or let your instrument change the registration automatically for you when you use **FILL IN 1** or **2**. The **MUSIC STYLE ARRANGER** will also alter the accompaniment in character with the registration change creating a polished sounding arrangement.

How to use the MUSIC STYLE ARRANGER

1. Select a rhythm pattern.
2. Press the **MUSIC STYLE ARRANGER** button to turn it on.



3. Use the **VARIATION** buttons to select a style (1 to 4).

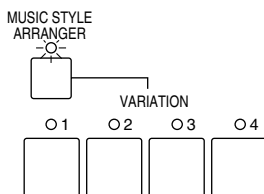

- The nuance of the pattern differs with each number.
- The panel settings (including the tempo) change according to the selected rhythm and music style. The **AUTO PLAY CHORD**, the **MEMORY** button and the **SYNCHRO & BREAK** button are automatically turned on. When a key on the left section of the keyboard is pressed, the automatic rhythm begins to play immediately.
- During your performance, the style can be changed, but the tempo does not change.

How to change the music style during your performance

While you are playing the keyboard with the **MUSIC STYLE ARRANGER** on, press the **FILL IN 1** or **FILL IN 2** button.

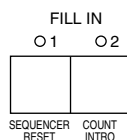

- Each time the **FILL IN 1** button is pressed, the **FILL IN 1** pattern plays, and then the music style changes in the **4 → 3 → 2 → 1** order. And each time the **FILL IN 2** button is pressed, the **FILL IN 2** pattern plays, and then the style changes in the **1 → 2 → 3 → 4** order.

■ MUSIC STYLE ARRANGER mode

You can define which panel settings change by pressing a **FILL IN** button when the **MUSIC STYLE ARRANGER** is used.

1. Press and hold the **MUSIC STYLE ARRANGER** button for a few seconds.
- The display changes to the following.

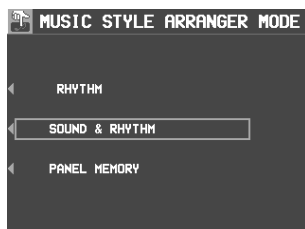

2. Select the mode.

RHYTHM:

Only the rhythm changes.

SOUND & RHYTHM:

The sound, effects, rhythms, etc. change.

PANEL MEMORY:

The **PANEL MEMORY** number (BANK A: **1** to **4**) changes. You can store your desired panel settings in the **PANEL MEMORY** beforehand and switch from one to another quickly.

- After a few seconds, the display exits the setting mode.
- You can also access this setting display from the **CONTROL MENU** display. (Refer to page 171.)

Panel Memory

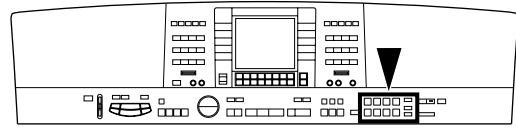

PANEL MEMORY stores all the current panel settings so you can recall them at the push of a button.

How to store the panel settings

By storing all the panel settings you use for a song in the same bank, for example, you can switch from one panel setup to the next in a flash.

1. Set up the desired panel settings (sounds, volumes, etc.)
2. Press the **BANK VIEW** button to turn it on.

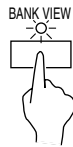

- The **BANK SELECT** display appears.
3. Select the desired bank (A, B, C).
 4. With the **SET** button held down, press one of the numbered buttons of the **PANEL MEMORY** (1 to 8).

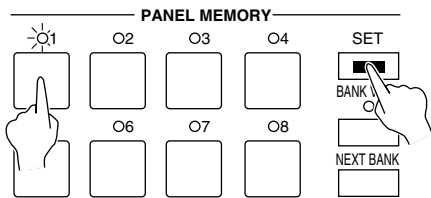

- The panel settings are now stored in the specified bank and number.

■ BANK VIEW

After selecting a bank, you can use the **PAGE** buttons to go to the **PAGE 2/2** page and confirm the memory names of that bank's 8 memories.



- You can use the **BANK** \wedge and \vee buttons to view other banks.
- You can also access this display by pressing and holding any of the **PANEL MEMORY** number buttons (1 to 8) for a few seconds.

Assign a name to the bank/memory

You can assign names to the banks and memories.

1. Select a bank or memory.
2. Use the **PAGE** buttons to go to the PAGE 2/2 page on the display.



3. Press the **BANK NAMING** button to assign a name to the bank, or the **MEMORY NAMING** button for the memory.
 - The display looks similar to the following.



4. Use the buttons below the display to assign a name.
 - Set the character input position with the **POSITION** buttons, select the characters with the alphanumeric buttons and repeat name assignment.
 - Switch from upper to lower case letters with the **ABC, abc** button.
 - Press the **INS** button to enter a space at the cursor position.
 - Press the **DEL** button to erase the character at the cursor position.
 - Press the **CLR** button to erase the entire name.
 - Press the **→←** button to center the name.
5. When you have finished assigning the name, press the **OK** button.

Recall the panel setup

1. Press the **BANK VIEW** button to turn it on. Select a bank.
2. Press the desired **PANEL MEMORY** number button (1 to 8).
 - The panel setup changes to the one stored in the specified memory.
 - You can then change the sound settings, etc. manually; however, the contents of the memory remain unchanged until you store them again.
 - The “Control Preset” bank of the **PERFORMANCE PADS** or the Foot Switch (sold separately) can also be used to change from one **PANEL MEMORY** setup to another. (Refer to pages 64, 172.)
 - The currently selected bank, memory number and memory name are shown in the top line on the normal display.

■ NEXT BANK

You can press the **NEXT BANK** button to switch to the next bank. This allows you to change banks without exiting the normal display.



- Each time the **NEXT BANK** button is pressed, the bank indication changes in order (A → B → C → A → B ...).
- The panel settings change when a **PANEL MEMORY** number button (1 to 8) is pressed.

PANEL MEMORY mode

You can define which panel settings are recalled when the **PANEL MEMORY** is used.

1. Press and hold the **SET** button for a few seconds.
- The display changes to the following.

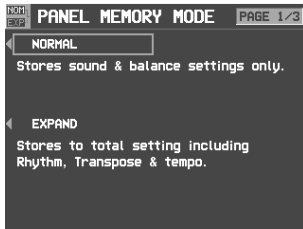

2. Select the mode.

NORMAL:

The sounds and volume balance, and **CONDUCTOR** status are stored.

EXPAND:

All the instrument's settings are stored, including the rhythm (except for **SOUND ARRANGER** on/off status), **TRANPOSE**, tempo, etc.

- After a few seconds, the display exits the setting mode.

■ EXPAND MODE FILTER

You can specify which data is stored in the EXPAND mode.

1. Use the **PAGE** buttons to access the PAGE 2/3–3/3 EXPAND MODE FILTER display.
- The display looks similar to the following.

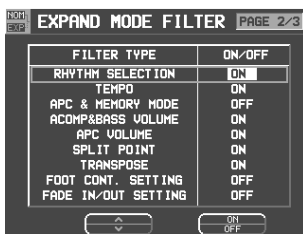

2. Use the \wedge and \vee buttons to select the item.
3. Use the ON and OFF buttons to store the on or off status for the selected item.

Part III Performance Pads

Playing phrases

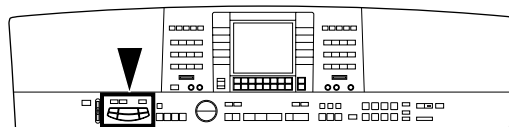

During your performance, you can insert a short recorded phrase or effect sounds by pressing a pad button. A different group of phrases is recorded in each bank.

1. Press the **BANK** button.



2. Select the desired bank from the display.

- The list of banks consists of three screen pages. Use the **PAGE** buttons to change the page.

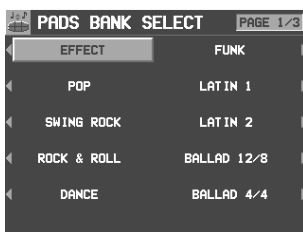

- “User Bank” A, B and C are for storing your original phrases.
- “Compile Bank” 1 and 2 are for assigning phrases as you desire.
- Various functions are assigned to each pad button in “Control Preset”.
 - 1: ROTARY SLOW/FAST
 - 2: PANEL MEMORY BANK INCREMENT
 - 3: GLIDE
 - 4: PANEL MEMORY DECREMENT
 - 5: PANEL MEMORY BANK DECREMENT
 - 6: PANEL MEMORY INCREMENT

- When using the “Control Preset” bank, set the **AUTO SETTING** button to OFF. When using the **PANEL MEMORY**, turn off the **PERFORM. PADS BANK** of the **EXPAND MODE FILTER**.

3. Press a pad button (1 to 6).

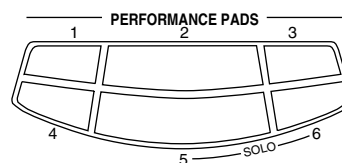

- A different phrase is assigned to each pad button.
- Information about the phrase, such as its name and the measure number, is shown in the normal display.
- The volume can be set with the buttons below the normal display (PADS).
- The selected phrase is played in the current tempo.
- To stop the phrase before it has ended, press the **STOP** button.
- Some phrases continue to play until the **STOP** button is pressed (the [Loop] indication appears).
- During a rhythm performance, some phrases may play in time with the measure count.
- When the automatic accompaniment is on, several phrases are played in the specified chord.

SOLO

Pad buttons **5** and **6** (**SOLO**) are phrases with chord progressions. Just by pressing one of these pad buttons, the phrase changes following a chord progression that is typical for the music genre of that bank.

- Use with the automatic accompaniment during your performance.
- Pad button **5** accesses a major chord progression, and pad button **6** a minor chord progression.

AUTO SETTING

When this button is set to on, the bank automatically changes according to the automatic setting functions in the **ONE TOUCH PLAY**, the **MUSIC STYLE ARRANGER** and the **MUSIC STYLIST**. When it is set to off, the bank does not automatically change according to these functions.



Copying phrases

You can copy the desired data, as phrases, from the **SEQUENCER** to each pad memory of a "User Bank".

- Chord data also can be copied to pad buttons **5** and **6** (**SOLO**).

PHRASE COPY

Copy a phrase from one pad to another.

1. Press the **PROGRAM MENU** button to turn it on.

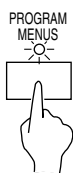

- The display looks similar to the following.

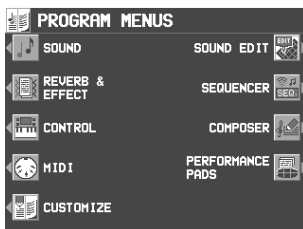

2. Select **PERFORMANCE PADS**.
 - The display looks similar to the following.

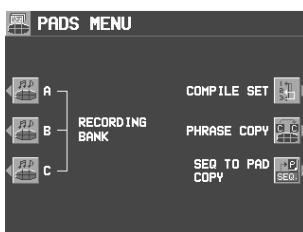

3. Select **PHRASE COPY**.
 - The display looks similar to the following.

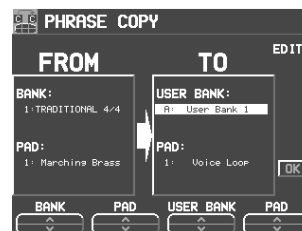

4. Select the pad you wish to copy from.
 - Use the buttons on the FROM side to set the desired settings.
 BANK: Bank name
 PAD: Pad number (1 to 6)
5. Select the pad you wish to copy to.
 - Use the buttons on the TO side to set the desired settings.
 USER BANK: Bank name (USER A, B, C)
 PAD: Pad number (1 to 6)
 - Only a **SOLO** phrase can be copied to the **SOLO** pads (5 and 6).

6. Press the **OK** button.

7. Press the **PROGRAM MENU** button to turn it off.

- If you wish to modify a portion of the copied phrase, press the **EDIT** button to change to the recording display.

SEQ TO PAD COPY

- Record a phrase in the **SEQUENCER**, or load data from a disk.
 - After this procedure, please do not change the song number.
 - For details about **SEQUENCER** operation, refer to page 73.
 - For information about loading data, refer to pages 120, 133.
- Press the **PROGRAM MENUS** button to turn it on.
- Select **PERFORMANCE PADS**.
- Select **SEQ TO PAD COPY**.
 - The display looks similar to the following.



- Select the measures of **SEQUENCER** data you wish to copy from.
 - On the **SEQUENCER** side, use the buttons to make the corresponding settings.

FIRST MEASURE:

The first measure of the phrase you wish to copy.

LAST MEASURE:

The last measure of the phrase you wish to copy.

TRANSPOSE:

The setting to transpose the chords when they are copied.

- The maximum that can be copied is 16 measures.
- When copying to pad button **5** or **6**, the chord (STEP) track is automatically displayed, and the chord data is also copied. However, when chord data from step record input does not exist, the measures are blank.
- If you wish to convert the chords during playback, set **TRANSPOSE** to the key of C and then copy the phrase.

- Select the pad button you wish to copy to.
 - On the **PERFORMANCE PAD** side, use the buttons to make the corresponding settings.

USER BANK:

The name of the bank (A/B/C).

PAD:

Pad button number (1 to 6).

PART:

The part to copy to.

TRACK:

The track number to copy from.

- Press the **OK** button.
 - A confirmation display appears. Press the **YES** button if you wish to copy the phrase, or press the **NO** button to cancel the procedure.
- When you have completed the procedure, press the **PROGRAM MENUS** button to turn it off.

Compile

You can assign desired phrases from different banks in “Compile Bank” 1 and 2.

1. Press the **PROGRAM MENUS** button to turn it on.

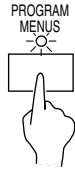

- The display looks similar to the following.

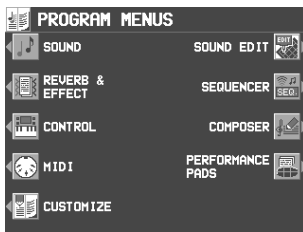

2. Select **PERFORMANCE PADS**.

- The display looks similar to the following.

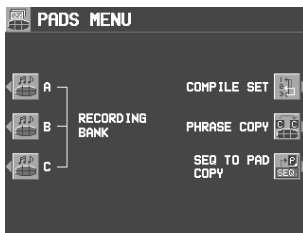

3. Select **COMPILE SET**.

- The display looks similar to the following.



- You can press the **NAMING** button and assign a name to the bank.

4. Press the **BANK** button to select a bank (Compile Bank: 1/2).

5. Use the **PADS** ▲ and ▼ buttons to select the pad to which to assign the phrase.

6. Use the **BANK** and **PHRASE** ▲ and ▼ buttons to select the desired bank and phrase you wish to assign.
 - The “Control” bank cannot be selected.

7. Repeat steps 5 and 6 to assign phrases to the other pad buttons.

8. When you have finished assigning the phrases, turn off the **PROGRAM MENUS** button.

Record a phrase

“User Bank” A, B and C are reserved for storing your original phrases.

- You can also copy phrases which are recorded in the **SEQUENCER**.

1. Press the **PROGRAM MENUS** button to turn it on.

- The display looks similar to the following.

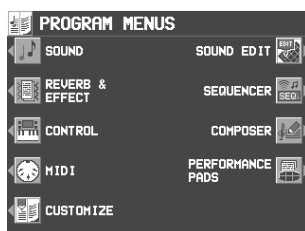

2. Select **PERFORMANCE PADS**.

- The display looks similar to the following.

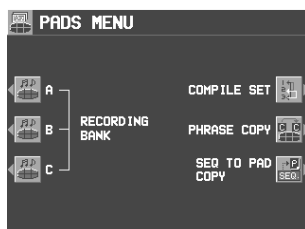

3. Use the buttons to the left of the display to select a **RECORDING BANK**.

- The display changes to the **RECORD PAD** display.
- You can press the **BANK NAMING** button and assign a name to the bank.
- If the **BANK CLR** button is pressed, all the data in the bank is cleared (a confirmation display appears).

4. Use the buttons below the display to select the pad number to record.

- The display changes to the **PAD RECORDING** display.
- You can press the **PAD NAMING** button and assign a name to the bank.
- To clear all the current data in the selected pad, press the **CLEAR THE PAD** button, and then press the **YES** button on the confirmation display.

5. Use the **MEAS** \wedge and \vee buttons specify the number of measures in the phrase. Use the **TIME SIGNATURE** \wedge and \vee buttons to specify the time signature of the phrase.

6. Press the **OK** button.

- For details about **KEY SETTING**, refer to page 111.
- For details about **CHORD MODIFY CHANGE**, refer to page 109.

7. Select the part to record to.

- Press the button for **PART 1** or **PART 2**.
- Two parts can be recorded (**PAD 1–4**).
- The display looks similar to the following.



8. Proceed to record.

- The recording procedure is the same as for the **COMPOSER**. (Refer to page 104.)
- In the **PLAY SETTING**, if **LOOP** is set to **OFF**, **LOOP** recording is not possible.

PLAY SETTING

Select a playback mode.

1. On the PAD RECORDING display, press the PLAY SETTING button.
 - The display looks similar to the following.



2. Use the START \wedge and \vee buttons to select a playback mode.

SYNCHRO:

During a rhythm performance, the phrase playback begins in time with the measure.

INSTANT:

The phrase starts to play immediately when the pad button is pressed, regardless of the rhythm.

3. Use the LOOP \wedge and \vee buttons to enable or disable loop playback.

ON:

Once the pad button is pressed, the phrase is played back repeatedly until the STOP button is pressed.

OFF:

The phrase is played back only once.

CHORD STEP RECORD

A chord progression can be stored in PAD 5 and PAD 6.

1. On the REALTIME RECORDING display, press the CHORD STEP RECORD button.
 - The display looks similar to the following.

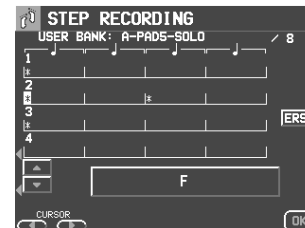

2. Use the CURSOR buttons to move the cursor to the position you wish to input.
 - The cursor moves in 1/8-note increments.
3. Input the chord by playing it on the keyboard.
 - The chord name is shown.
4. Press the OK button.
5. Repeat steps 2 to 4 to store the rest of the chord progression.
 - To delete a chord which has been input, move the cursor to the specific chord and press the ERS button.

Part IV Sequencer

Outline of the Sequencer

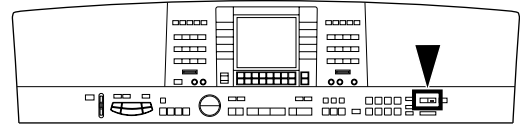

A sequencer records your performance in a similar way to a tape recorder. This instrument's **SEQUENCER** allows you to record up to 10 performances in a variety of ways. You may want to record your entire performance in one go (especially if you are using **AUTO PLAY CHORD** to provide the accompaniment), or to build up a complex arrangement with several different parts playing together, like an orchestral score. This instrument's **SEQUENCER** has 16 tracks. This means that you can record 16 different parts. However, you don't have to use all 16 tracks. For some uses you may only need to use one or two tracks. This instrument's **SEQUENCER** enables you to edit your recorded performance. Unlike a tape recorder you can change the sound or the tempo during playback, or correct wrong notes or timing errors.

SEQUENCER features

■ You can change the tempo without changing the pitch

When you record your performance at a slow tempo and play it back at a faster tempo, the pitch stays the same.

■ Consistent sound

Your performance is reproduced by a sound module as it reads digital data. So, unlike a recorded tape, the sound never deteriorates no matter how many times you play back your performance.

■ Edit your recorded performance

Comprehensive editing functions allow you to modify your recorded performance. Data can easily be erased, corrected or copied, providing an especially convenient tool for creating your original tunes.

■ Instant search

A recorded tape has to be rewound, but digital action means you can return to the beginning of your performance, or find any measure, instantly.

Popular features

■ Simplified recording method

EASY RECORD is a feature that allows you to bypass the more complex recording procedures so you can record and play back your performance quickly and easily.

- You can also record an accompaniment from the **AUTO PLAY CHORD**.

■ Create a one-man ensemble

Use the **REALTIME RECORD** function to record your performance in up to 16 tracks and create your own orchestra or band.

■ Store individual data to create your song

For repeating patterns or those especially complicated phrases, the **STEP RECORD** feature is convenient for recording the notes one-by-one.

- This method can be used to store both the chord progression for the automatic accompaniment and the rhythm changes.

Memory capacity

Up to 10 songs can be stored in the **SEQUENCER**. Expressed in terms of notes, the total number of notes which can be stored in all the **SEQUENCER** songs and tracks is about 40,000. The remaining memory available for recording is shown on the display as a percentage (**MEMORY= %**).

- When "Memory full!" appears on the display, no more data can be stored in the **SEQUENCER**.

SEQUENCER menu

The configuration of the **SEQUENCER** setting display is as follows.

1. Press the **PROGRAM MENUS** button to turn it on.

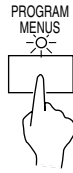

- The display looks similar to the following.

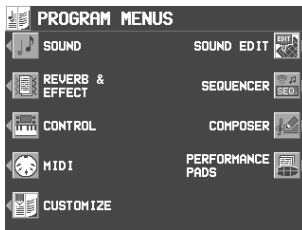

2. Select **SEQUENCER**.

- The display looks similar to the following.



(KN2600)

- The **SONG** ^ and v buttons are used to select a song.
- You can press the **NAMING** button and assign a name to the song. (Refer to page 83.)
- You can press the **PANEL WRITE** button to store the current settings of the instrument at the beginning of the song. (Refer to page 83.)
- **KN2600**: Pressing the **SD AUDIO SYNCHRO** button will set the synchronization of the **SEQUENCER** playback and the sound data stored in the SD card. (Refer to page 103.)

3. Select **RECORD & EDIT**, **COPY & PASTE** or **RANGE SET**, and follow the corresponding procedure.

<RECORD & EDIT>



<COPY & PASTE>

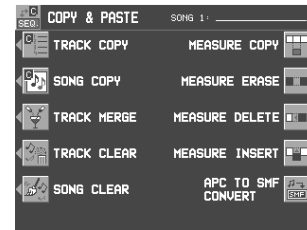

<RANGE EDIT>

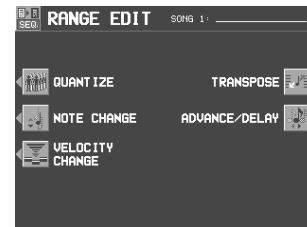

Summary of the SEQUENCER menu items

RECORD & EDIT

These functions are recording and editing operations used for creating a new performance.

REALTIME RECORD (page 78)

Record each part of your performance just as you play it on the keyboard.

PUNCH RECORD (page 84)

Correct a selected portion of your recorded performance.

STEP RECORD (page 86)

Store the sounds note-by-note on the display.

- You can also store the chord or rhythm progression for the **AUTO PLAY CHORD**.

TRACK ASSIGN (page 91)

Assign parts to tracks.

QUANTIZE (page 92)

Correct the timing of your performance.

SONG SELECT (page 84)

Select a song.

SONG CLEAR (page 93)

Erase all the recorded data of a song.

TRACK CLEAR (page 93)

Erase the contents of a specific track.

NOTE EDIT (page 94)

Store and correct performance (NOTE) data on a piano roll display.

DRUM EDIT (page 95)

Store and correct DRUMS part data on a special display.

COPY & PASTE

Copy recording data and paste it to the desired location.

TRACK COPY (page 97)

Copy data of specific tracks.

SONG COPY (page 97)

Copy data of specific songs.

TRACK MERGE (page 98)

Merge the recorded contents of two tracks and store in a third track.

TRACK CLEAR (page 97)

Erase the contents of a specific track.

SONG CLEAR (page 97)

Erase all the recorded data of a song.

MEASURE COPY (page 98)

Copy the contents of specific measures.

MEASURE ERASE (page 99)

Erase the contents of specific measures.

MEASURE DELETE (page 99)

Delete specific measures from the performance.

MEASURE INSERT (page 100)

Insert additional measures in the performance.

APC TO SMF CONVERT (page 100)

Save automatic accompaniment patterns and pad performance data in a Standard MIDI File (SMF).

RANGE EDIT

Change the note position etc. in the recorded data.

QUANTIZE (page 96)

Correct the timing of your performance.

NOTE CHANGE (page 101)

Change the pitch of specific notes.

VELOCITY CHANGE (page 102)

Modify the recorded velocity (how hard the keyboard was played) of performance data.

TRANSPOSE (page 102)

Change the key of the performance data.

ADVANCE/DELAY (page 103)

Speed up or delay the sound production of performance data.

About the measure count

The measure count on the display corresponds to the time signature of the selected rhythm. However, if rhythm data is stored in the RHYTHM part and that part is played back, the measure count on the display corresponds to the stored rhythm data. (Refer to page 90.)

- If you wish to use a time signature not available in the preset rhythms, use the **COMPOSER** to create a new time signature. (Refer to page 106.)

Sequencer parts

The following summary explains what is stored in each **SEQUENCER** part.

Part name [name on display]	Used for	Recorded contents
RIGHT1 [RT1] RIGHT2 [RT2] LEFT [LFT] PART1 [P 1] – PART9 [P 9] PART11 [P 11] – PART16 [P16]	Recording the performance of each part (REALTIME/STEP)	<ul style="list-style-type: none"> • Sound and volume settings • PART EXPRESSION • Contents of sound and effect settings that can be set on the MIXER display (Refer to page 150.) • PITCH BEND wheel operation • MODULATION wheel operation (KN2600)
DRUMS [DRM] (PART 10)	Recording the drums performance with the DRUM KITS group sounds (REALTIME/STEP)	<ul style="list-style-type: none"> • Sound and volume settings • PART EXPRESSION • Contents of sound and effect settings that can be set on the MIXER display (Refer to page 150.)
CONTROL [CTL]	Recording changes in the panel button status (REALTIME/STEP)	<ul style="list-style-type: none"> • Rhythm setting and selection changes • RHYTHM VARIATION 1–4 setting • REVERB on/off • AUTO PLAY CHORD status, volume balance • MUSIC STYLE ARRANGER status • FILL IN 1, 2, INTRO & ENDING 1, 2 on • PANEL MEMORY selection changes • TRANPOSE status • TECHNI-CHORD status • START/STOP on/off • TEMPO setting • CONDUCTOR status • PERFORMANCE PADS setting • FADE IN/OUT operation • TOTAL EXPRESSION
AUTO PLAY CHORD [APC]	Recording chords for the AUTO PLAY CHORD (REALTIME)	<ul style="list-style-type: none"> • Chord progression • AUTO PLAY CHORD status, volume balance • START/STOP on/off • FILL IN 1, 2, INTRO & ENDING 1, 2 on
CHORD [CHD]	Recording chord progression for the AUTO PLAY CHORD (STEP)	<ul style="list-style-type: none"> • Chord progression • FILL IN 1, 2, INTRO & ENDING 1, 2 on
RHYTHM [RHY]	Settings related to rhythm (STEP)	<ul style="list-style-type: none"> • Rhythm settings and selection changes • RHYTHM VARIATION 1–4 setting • FILL IN 1, 2, INTRO & ENDING 1, 2 on • START/STOP on/off • TEMPO setting

- You can use the TRACK ASSIGN function to assign parts to tracks as you wish. (Refer to page 91.)

Easy Record

Suppose you are playing the Keyboard and you wish to record and play back your performance to hear how it sounds. You can bypass the set-up procedures of the full-scale sequencer and begin recording quickly and easily.

- Note that by executing **EASY REC**, the original data in the selected song number is erased.

Recording procedure

1. Press the **EASY REC** button to turn it on.

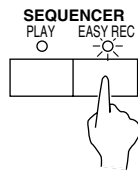

- The display changes to the following.



2. Use the **SONG** \wedge and \vee buttons to select the song number in which to record (1 to 10).
- If you press the **NAMING** button, you can assign a name to your song. (Refer to page 85.)
3. Set the desired sounds, effects, rhythms, etc.

4. Press the **OK** button.

- The display changes to the **REALTIME RECORD** display.

5. Play the keyboard.

- Recording begins as soon as you start the rhythm or play the keyboard.

6. When you have finished recording, press the **EASY REC** button to turn it off.

- The **PLAY** button turns on.

Playback

1. Press the **SEQUENCER RESET (FILL IN 1)** button.

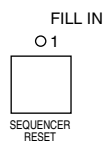

2. Press the **START/STOP** button.
 - Your recorded performance is played back automatically.
 - When you are finished playing back your performance, press the **SEQUENCER PLAY** button to turn it off.

Realtime Record

With REALTIME RECORD, your performance is recorded with the timing exactly as you played it on the keyboard. Use this mode to record your performance in up to 16 tracks and create your own orchestra or band.

Recording procedure

1. Press the **PROGRAM MENUS** button to turn it on.
- The display changes to the following.

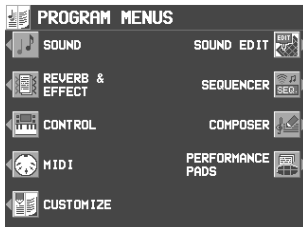

2. Select SEQUENCER.
- The display looks similar to the following.



- When you press the PANEL WRITE button, the PANEL WRITE display appears. To store the currently active settings, such as the sounds, at the beginning of the song, press the OK button.
3. Use the SONG ^ and v buttons to select a song number in which to record. (The song number is shown on the display.)

4. Select RECORD & EDIT.
- The display looks similar to the following.



5. Select REALTIME RECORD.

- The display looks similar to the following.



6. Use the buttons below the display to turn on the “REC” indication above the track numbers you are going to record.
 - While you are recording, you can play back tracks which are already recorded. Press the corresponding balance buttons to display “PLAY” above the track number you wish to have played back.
 - For the **RIGHT 1**, **RIGHT 2** and **LEFT** parts, you can select two or more tracks to record at one time; however, to record a performance part, the corresponding button in the **CONDUCTOR** must also be on. For parts that are not in the **CONDUCTOR**, multiple parts cannot be recorded at one time.
 - To record **AUTO PLAY CHORD** (APC) parts, turn on the **AUTO PLAY CHORD**'s **OFF/ON** button. In this case, press the **START/STOP** button when beginning recording.
 - The track for the RHYTHM (RHY) part can be selected for recording only when STEP RECORD is active.
7. Set the sounds, effects, volumes, etc. for the parts you are going to record.
 - If you press the MIXER button, you can use the MIXER display to visually adjust the settings for each track.
 - The LOCAL ON/OFF setting on the MIXER display is used to specify whether the part assigned to that track sounds when it is played on the keyboard during recording. For the LOCAL ON/OFF during playback, use the TRACK ASSIGN display to adjust the settings. (Refer to page 91.)
 - If you are recording GM2 song data, select from the GM2 group in the **SOUND EXPLORER**.
 - The panel settings which are active at the beginning of recording are stored.

8. Use the **TEMPO/PROGRAM** to adjust the recording tempo.
 - The tempo is shown on the display as ♩=.
 - If you wish to record the tempo setting and tempo changes, store them in the control (CTL) part, or use the step record to store them in the rhythm (RHY) part.
 9. Turn the metronome on or off as desired with the ON/OFF button at the upper right of the display.
 - The metronome selection alternates between ON and OFF each time the button is pressed.
 - When set to ON, the metronome volume setting display is momentarily shown.
 - The metronome sound is not recorded.
 10. Play the keyboard.
 - Recording begins.
 - You can also press the **START/STOP** button to start the rhythm and begin recording.
 - If the metronome is on, when you press the **START/STOP** button, a two-measure count plays, after which recording automatically begins. In this case, the rhythm does not start. Recording does not start until the two-measure count is completed.
 - The recording status is continuously updated on the display:
 - MEASURE= indicates the current measure.
 - TIME SIG.= indicates the current time signature.
 - MEMORY= indicates the remaining memory (%) available for recording.
 - If you wish to redo the recording, press the REC STOP button and then record again. To change the sounds and effects, etc. please set them again.
 - If you make a mistake in recording, you can correct a specific portion of your performance without having to redo the whole part. (Refer to page 84.)
 11. When you have finished recording, press the REC STOP button on the display, or turn off the **PROGRAM MENUS** button.
 - When the **PROGRAM MENUS** button is turned off, the ending command (END) is recorded. Note that, as long as the ending command is not recorded, blank recording continues even if you stop playing.
 - The **SEQUENCER PLAY** button turns on.
- **Multi-track recording**
- Use the following procedure to record one track while listening to the track or tracks already recorded.
1. Follow the procedure to record the first track, and press the REC STOP button at the end of the recording.
 - The indication for the track just recorded changes from “REC” to “PLAY”.
 2. Turn on the “REC” indication for the track you wish to record next, and select the sounds and effects, etc.
 3. Press the **START/STOP** button and begin recording.
 - Tracks for which “PLAY” is shown are played back, and you can record in time with this.
 - If you turn on the “REC” for the CONTROL track and begin recording, the rhythm start will not be recorded.
 4. Press the REC STOP button at the end of the recording.
 5. Repeat steps 2 to 4 for other tracks, as desired.
 6. When multi-track recording is finished, turn off the **PROGRAM MENUS** button.
 - If you wish to store part settings that you modified after recording as beginning song data, press the MIXER button and follow the PANEL WRITE procedure. (Refer to page 83.)

CYCLE RECORD

This mode allows you to have specified recording measures continuously repeated. Thus you can record measures by adding notes during any cycle.

1. On the REALTIME RECORD display, specify "REC" for a track number you are going to record, and "PLAY" for track numbers you wish to have played back.
2. Press the CYCLE: OFF button.
 - The display looks similar to the following.



3. Use the START MEASURE \wedge and \vee buttons to specify the beginning measure number.
4. Use the END MEASURE \wedge and \vee buttons to specify the ending measure number.
 - The measure in which the END command has been stored can also be specified.

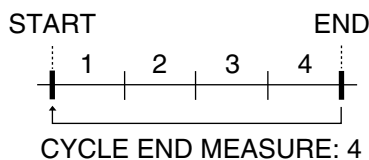

5. Press the **START/STOP** button.
 - If the metronome is on, cycle recording of the specified measures begins after a two-measure count.
6. Play the keyboard.
 - The specified measures are repeated, during which time you can record by adding notes little by little at the correct timing (over-dubbing).
 - If you wish to erase all the performance data from the specified measures, press the CLEAR button.
 - If the CYCLE: ON button is pressed, it changes to OFF. This button does not function during recording.
 - To return to the REALTIME RECORD display, press the **EXIT** button.
 - Cycle record can also be started from the REALTIME RECORD display whenever the CYCLE: ON indication is shown.

Sequencer Play

Play back your recorded performance.

1. Press the **SEQUENCER PLAY** button to turn it on.

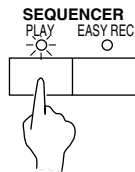

- The display looks similar to the following.



2. After pressing the **SONG** button, use the **SONG** \wedge and \vee buttons to select a song number for playback.
3. Use the balance buttons below the display to show “PLAY” above the track numbers you wish to have played back.
 - Highlighted track numbers indicate tracks that are already recorded. Only highlighted track numbers can be selected for playback.
 - You can select two or more tracks to play back at one time.
4. Press the **SEQUENCER RESET (FILL IN 1)** button.
 - The **SEQUENCER** returns to the beginning of the song and the beginning panel settings are recalled.

5. If you want to playback a song starting from a point other than the first measure, use the **MEAS** \wedge and \vee buttons to specify the measure number.
 - “MEASURE=” indicates the current measure number.

6. Press the **START/STOP** button.
 - The recorded performance is played back from the specified measure.
 - When playback is begun from a measure in which an **INTRO**, **COUNT INTRO**, **FILL IN** or **ENDING** is recorded, the corresponding function does not work.
 - You can press the **MIXER** button and modify the settings for each part.
 - For information about **LYRICS**, refer to page 123.

7. To stop playback, press the **START/STOP** button.
 - If the **START/STOP** button is pressed again, playback will continue from the point it was interrupted.
8. When you are finished playing back your performance, press the **SEQUENCER PLAY** button to turn it off.

If a rhythm progression has been recorded in the RHYTHM (RHY) part, the MEASURE display used in the STEP RECORD and EDIT displays conforms to the time signature data stored in the RHYTHM part.

Adjusting the playback tempo

Even with a song having recorded tempo data, you can use **TEMPO/PROGRAM** or **TAP TEMPO** to adjust the tempo to your liking.

- When the tempo is changed, all the tempo data of that song is automatically changed by the same ratio. Accordingly, even in song data in which tempo change data is stored, a single adjustment of the tempo produces a natural-sounding playback.
- To return to the original tempo, while the song is stopped press the **SEQUENCER RESET** button. Note that the tempo change is also canceled when you switch to another song or load a new song.
- The adjusted tempo is canceled when you begin the recording procedure and the original tempo data will be recorded.

CYCLE PLAY

You can have specified measures played back repeatedly.

1. On the SEQUENCER PLAY display, specify "PLAY" for track numbers you wish to have played back.

2. Press the CYCLE button.

- The display looks similar to the following.



3. Use the START MEASURE \wedge and \vee buttons to specify the beginning measure number.

4. Use the END MEASURE \wedge and \vee buttons to specify the ending measure number.

- The measure in which the END command has been stored can also be specified.

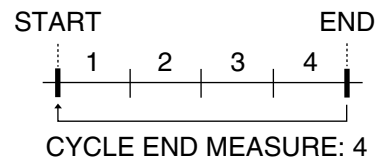

5. Press the **START/STOP** button.

- Cycle playback of the specified measures begins.
- Normally the rhythm pattern is not played back.

6. To stop cycle playback, press the **START/STOP** button again.

- During playback stop, if the **SEQUENCER RESET (FILL IN 1)** button is pressed, the **SEQUENCER** returns to the measure number specified in step 3. If the **SEQUENCER RESET** button is pressed again, the **SEQUENCER** returns to measure 1.
- If you press the CYCLE: ON button to turn it OFF, cycle playback is not possible.
- To return to the SEQUENCER PLAY display, press the **EXIT** button.
- Cycle playback can also be specified on the SEQUENCER PLAY display whenever the CYCLE: ON indication is shown.

MEDLEY

Recorded songs can be played back in a medley.

1. On the SEQUENCER PLAY display, press the MEDLEY button.

- The display looks similar to the following.

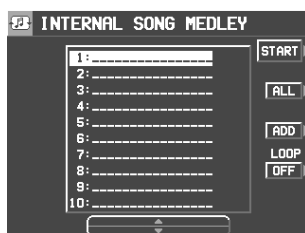

2. Specify the order of songs in the medley.

- If ALL is pressed, all the files are selected, and the songs are played back in order in a medley. If ALL is pressed again, the files are deselected.
- You can use the buttons below the display to select a song to add to the song list, then press the ADD button to add it to the list. Repeat these steps to create your own list of songs to have played back. A M01, M02 etc. next to the file name indicates its order in the list.
- You can delete a marked file from the medley song list by selecting it and pressing the ADD button.
- Use the LOOP button to specify ON or OFF for repeat playback of the medley.

3. Press the START button.

- During medley playback, you can use the SKIP button to skip to the next song.

Naming

Here is the way to assign a name to your recorded song.

1. On the SEQ MENU display use the SONG SELECT \wedge and \vee buttons to select a song.
2. Press the NAMING button.
 - The display looks similar to the following.

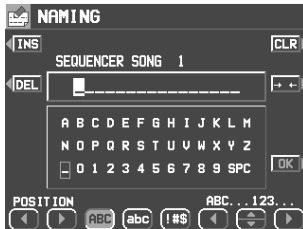

3. Use the buttons below the display to assign a name.
 - Set the character input position with the POSITION buttons, select the characters with the alphanumeric buttons and repeat name assignment.
 - Switch from upper to lower case letters with the ABC, abc button.
 - Press the INS button to enter a space at the cursor position.
 - Press the DEL button to erase the character at the cursor position.
 - Press the CLR button to erase the entire name.
 - Press the $\rightarrow\leftarrow$ button to center the name.

4. Press the OK button.

Panel Write

You can change the panel status which is in effect at the beginning of the song. These are the settings which are recalled when the **SEQUENCER RESET** button is pressed.

1. On the SEQ MENU display, use the SONG \wedge and \vee buttons to select the song number. Then select PANEL WRITE.
 - The display looks similar to the following.



2. Use the panel buttons to change to the desired panel settings.

3. Press the OK button.
 - "COMPLETED!" is shown on the display.
 - PANEL WRITE is automatically activated at the when you start to record.
 - For rhythm data, the data in the RHYTHM part has priority.

Song Select

You can select a desired song from the list of recorded songs.

1. On the SEQ MENU display, select RECORD & EDIT.
2. On the RECORD & EDIT display, select SONG SELECT.
 - The display looks similar to the following.

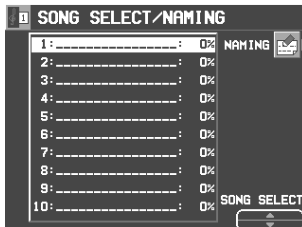

3. Use the SONG SELECT ▲ and ▼ buttons to select a song.
 - The total amount of memory used for the current song is shown as a percentage (%) to the right of the song name.
 - If the NAMING button is pressed, the NAMING display appears.
 - To optimize memory, songs you do not wish to preserve should be deleted. (Refer to page 93.)

Punch Record

If you make a playing error during REALTIME RECORD or would like to change the recording for some other reason, you can use the punch recording feature to correct a selected portion of the performance without having to redo the whole part.

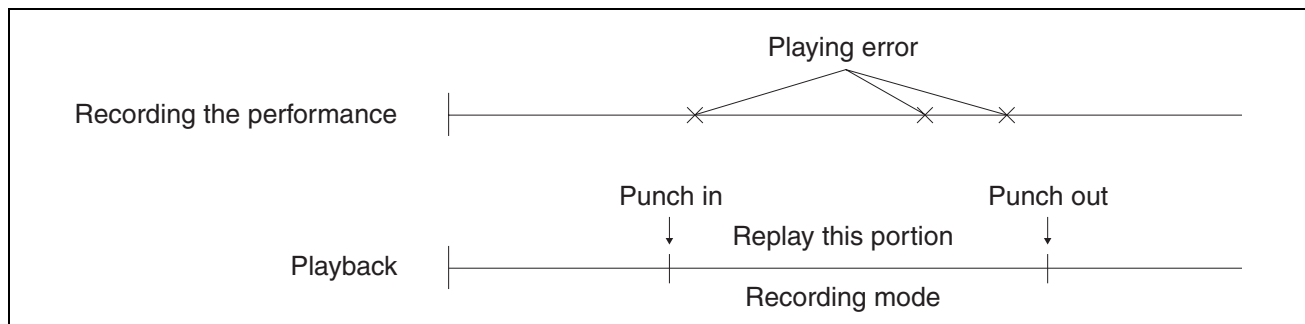

1. On the SEQ MENU display, use the SONG SELECT ▲ and ▼ buttons to select the song number. Then select RECORD & EDIT.
2. On the RECORD & EDIT display, select PUNCH RECORD.
 - The display looks similar to the following.

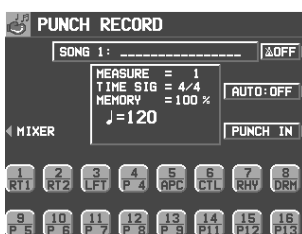

3. Select the track which contains the portion you want to correct.
 - You cannot select a track in which no data is stored.
 - On the display “REC” indicates tracks which are being recorded, and “PLAY” indicates tracks which are being played back.
4. Use the MEAS ▲ and ▼ buttons to specify the beginning measure of playback.
 - “MEASURE=” indicates the current measure number.
5. Press the **START/STOP** button to begin playback of the specified track.

6. During playback, press the PUNCH IN button at the point you want to begin recording.
 - Recording begins as soon as the PUNCH IN button is pressed. Begin playing at this point.
 - The REC indication changes to the PUNCH indication.
 - The PUNCH IN button switches to the REC STOP button.
7. Press the REC STOP button at the point you want to stop recording.
 - Punch recording stops immediately.
 - You can also begin punch-in recording by playing the keyboard.
 - You can specify the punch-in/punch-out points with the optional Foot Switch (sold separately). (Refer to page 172.)

■ AUTO PUNCH RECORD

You can also set the punch-in and punch-out points beforehand, so that recording automatically begins and ends at the specified points.

1. On the PUNCH RECORD display, press the AUTO: OFF button.
 - The display looks similar to the following.

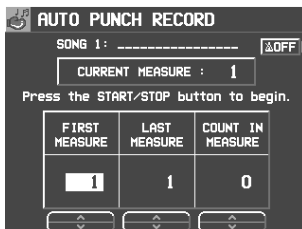

2. Use the FIRST MEASURE \wedge and \vee buttons to specify the number of the punch-in measure.
3. Use the LAST MEASURE \wedge and \vee buttons to specify the number of the punch-out measure.
 - The number of the LAST measure must be higher than the number of the FIRST measure.
 - The specified measure is recorded.
4. Use the COUNT IN MEASURE \wedge and \vee buttons to specify the number of lead-in measures you wish to have played back before the punch-in measure.
 - Set the metronome to on or off with the ON or OFF button.
5. Press the EXIT button.
 - The display changes to the PUNCH RECORD display.

6. Press the **START/STOP** button.
 - Playback begins from the measure indicated by CURRENT MEASURE on the display.
 - Pertinent information, such as the FIRST MEASURE, is shown in the upper section of the display.
7. Correct the performance.
 - The mode changes automatically to the recording mode at the specified FIRST measure. Begin playing at this point. The mode automatically changes back to the playback mode at the specified LAST measure.
 - To discontinue punch recording in the middle, press the CANCEL button. In this case, the recorded contents up to that point are erased.

Step Record

STEP RECORD is simply a method of making a tune by storing the sounds note-by-note on the display. Instead of playing the keyboard directly as in the REALTIME RECORD mode, you can take your time to input each single note. This is an especially effective method for storing complicated passages that are difficult to play or when the exact timing of a part is critical.

Recording procedure

Record the keyboard performance and panel changes.

1. On the SEQ MENU display, use the SONG SELECT \wedge and \vee buttons to select the song number. Then select RECORD & EDIT.
2. On the RECORD & EDIT display, select STEP RECORD.
 - The display changes to the PART SELECT display.



3. Use the balance buttons below the display to specify the track for the part you are going to record (only one track can be selected at a time).
 - The display changes to the STEP RECORD input display similar to the following.

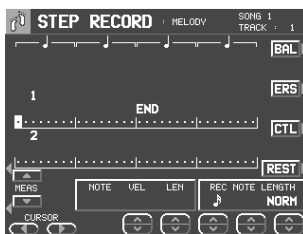

- If you selected the track to which the CHORD part has been assigned, the display changes to the STEP RECORD: CHORD display. (Refer to page 88.)
- If you selected the track to which the RHYTHM part has been assigned, the display changes to the STEP RECORD: RHYTHM display. (Refer to page 90.)
- If you selected the track to which the CONTROL part has been assigned, the display changes to the STEP RECORD: CONTROL display.

4. Use the MEAS \wedge and \vee buttons to select the measure.
 - This step is not necessary if you are recording from measure 1 of a blank track.
5. Use the CURSOR \blacktriangleleft and \blacktriangleright buttons to move the cursor to the note position (dot) you are going to store.
 - Each dot represents one-eighth of a quarter-note (a thirty-second note).
 - When storing triplets, it may not be possible to match the timing exactly with the 1/32-note steps. However, if you select triplet-type notes for the note length (LENGTH) in step 6 below, the timing is automatically corrected.
6. Use the left REC NOTE LENGTH \wedge and \vee buttons to specify the note value. Select from $\frac{3}{8}$, $\frac{2}{8}$, $\frac{1}{8}$, $\frac{3}{16}$, $\frac{2}{16}$, $\frac{1}{16}$, $\frac{3}{32}$, $\frac{2}{32}$, $\frac{1}{32}$, $\frac{3}{64}$, $\frac{2}{64}$, $\frac{1}{64}$, $\frac{3}{128}$, $\frac{2}{128}$, $\frac{1}{128}$, $\frac{3}{256}$, $\frac{2}{256}$, $\frac{1}{256}$, $\times 2$ to 4. (A 3 denotes a triplet-type note.)
 - For note values other than these, use the center REC NOTE LENGTH buttons to specify the note value to be added to that which you specified with the left buttons.

Example: To record a dotted quarter-note

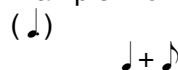

7. Use the right REC NOTE LENGTH \wedge and \vee buttons to specify the actual length of the produced sound for the desired legato or staccato effect.

TENU (tenuto): Sound is produced for 95% of the note length.
NORM (normal): 80%
STAC (staccato): 50%
CUTT (cutting): 25%

8. Specify the pitch and velocity of the note by playing the keyboard.
 - The dot on the display where the note is stored changes to a * mark.
 - When recording chords, you can store multiple notes at one position.

- Any panel setting changes—for example changes in the sound selection, button operation, wheel operation, etc.—are recorded at the cursor position.
- When a wheel or dial is operated, the input value is indicated on the display. Confirm that this is the correct value and press the YES button to record the value or the NO button to cancel it.

REST:

To store a rest, after specifying the note LENGTH, press the REST button.

- Positions at which nothing is stored are read as rests.

ERS:

If you make a mistake, move the cursor to the error, and after displaying the data you wish to erase, press the ERS button.

BAL:

To specify the volume at the cursor position, after pressing the BAL button, use the VALUE buttons to set the volume (0 to 127).

9. Repeat steps 4 through 8 to continue storing notes.
 - To input data on another track, press the button for the desired track and repeat the procedure from step 2.
10. When you have finished recording, press the **PROGRAM MENUS** button to turn it off.

■ Storing control data

Various control data can be stored at the cursor position.

1. On the STEP RECORD: MELODY display, press the CTL button.
2. Use the CTL \wedge and \vee buttons to select the control data you wish to insert.
 - Select from PAN, KEY SHIFT (COARSE TUNE), TUNING (FINE TUNE), BEND SENS.
3. Use the VALUE \wedge and \vee buttons to adjust the numerical value of the setting.
4. Press YES button.

■ Correcting the data

1. In the STEP RECORD mode, specify the track you wish to correct.
2. Use the MEAS buttons to go to the measure you wish to modify. Use the CURSOR buttons to move the cursor to the point (*) you wish to edit.
 - The data stored at that point is shown on the display.
 - When multiple data is stored at one point, different data is displayed in order each time a CURSOR button is pressed. When a chord is recorded, a different note in the chord is displayed each time a CURSOR button is pressed.
3. Correct the data.

There are three types of data:

Performance data

NOTE data (note pitch) and VEL data (how hard the key was played) and LEN data (1 = 1/96 of a quarter note [\downarrow]) are displayed. Use the relevant buttons to correct the data as desired.

Sound data

The name of the sound is displayed. Change the sound as desired (the sound setting display is interposed on the current display).

Control data

The name of the function is displayed. Change the data as desired.

- Press the ERS button to erase the data which is displayed.
- You can also correct data which was stored in the REALTIME RECORD mode.
- Performance (NOTE) data can be recorded or edited on a piano roll display, and there is also a specialized display for recording and editing the DRUMS part data. (Refer to page 94.)

Store a chord progression

Store the chord progression for the **AUTO PLAY CHORD** in the track for the CHORD part. Then, when the **AUTO PLAY CHORD** is used during playback, even if you do not specify the chords with your left hand, the chords change automatically.

- The chord length is specified with the **CHORD STEP RECORD** keys on the keyboard.



Note value keys

- Whole note
- Dotted half-note
- Half-note
- Dotted quarter-note
- Quarter-note
- Eighth-note

Reset key

Press to begin storing from the beginning.

Correction keys

- Move back one step.
- Move forward one step.

Repeat key

Press to end the chord-storing procedure and to specify automatic repeat playback of the stored progression.

End key

Press after the whole chord progression has been stored.

DELETE key

DELETE Press to erase data.

- To erase all the data from the current track, while pressing the **DELETE** key, press the End key ().

■ Example of storing a chord progression

Measure 1	2	3	4
C	C	Am F	D7 G7

1. On the SEQ MENU display, use the SONG SELECT ^ and v buttons to select the song number. Then select RECORD & EDIT.
2. On the RECORD & EDIT display, select STEP RECORD.
 - The display changes to the PART SELECT display.
3. Using the balance buttons below the display, select the track to which the CHORD (CHD/APC) part has been assigned.
 - The display changes to the STEP RECORD: CHORD input display similar to the following.

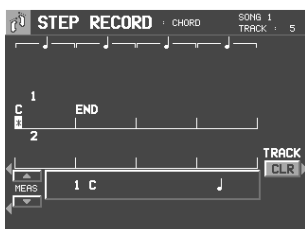

- STEP REC: CHORD can also be enabled by pressing on the **EASY RECORD** button continuously a few seconds. This will display the CHORD screen.

4. Store the chords.

<Measure 1, measure 2>
While playing a C chord with your left hand, press the key one time with your right hand.

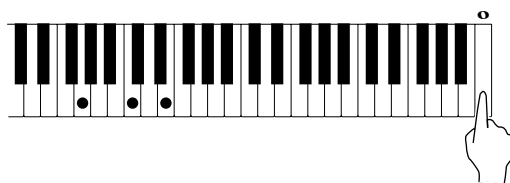

- A “beep” tone indicates that the chord has been successfully stored.
- The dot on the display where the chord is stored changes to a * mark and the cursor automatically moves forward, in accordance with the specified note value, to the next unrecorded position. The chord name is shown on the display.

<Measure 3>

- (1) While playing an Am chord, press the ♩ key one time.

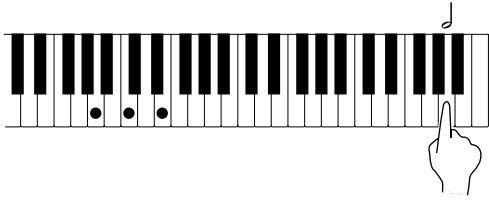

- (2) While playing an F chord, press the ♩ key one time.

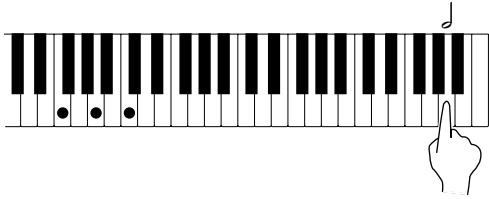

<Measure 4>

- (1) While playing a D7 chord, press the ♩ key one time.

- (2) While playing a G7 chord, press the ♩ key one time.

- You can press the **INTRO & ENDING** button or a **FILL IN** button on the panel to store the desired pattern at the cursor position. (An **INTRO** or **COUNT INTRO** can be stored only at the beginning.)
- Store a rest by pressing a note value key without specifying a chord.

5. At the end of the chord progression, press the End key (—H).

- The Keyboard exits the recording mode.
- During playback, playback of the recorded chord progression stops at this point. For automatic repeat playback of the chord progression, press the Repeat key (↔) instead of the End key (—H).

- When you play back the track for the CHORD part, the chords of the automatic accompaniment change in accordance with the stored chord progression.
- To specify chords by the <one finger> mode, select the BASIC mode before entering the STEP RECORD mode.
- If the ON BASS button is on, chords such as “C on G” can also be specified (except in the <one finger> mode).
- The CHORD FINDER feature, which shows you how to finger a specified chord, is available. (Refer to page 55.)

■ Correct the recorded chord progression

- Follow the procedure to select the STEP RECORD: CHORD display.
- Use the MEAS buttons to go to the measure you wish to modify. Use the ◀ and ▶ Correction keys to move the cursor to the point (*) you wish to edit.
 - The lengths of rests are indicated by the respective rest value × its multiplier.

Example:

- ζ 1-beat rest (quarter rest)
- γ 1/2-beat rest (eighth rest)
- ζ × 1 + γ 1-1/2-beat rest (dotted quarter rest)
- ζ × 10 10-beat rest

- To go to the end of the chord progression, while pressing the Reset key (⏮), press the ◀ key.

- Correct the chord data.

Chord data

When the chord name is displayed at the cursor position, you can press the **DELETE** key to erase the data and then store a new chord.

- If you do not erase the displayed data before entering new chord data, the new data is inserted at this point, and the displayed data is merely shifted by the note value of the new chord.
- Rests can also be erased. Each time the **DELETE** key is pressed, the rest is erased in units of ζ × 1. The γ rest is erased last.
- If you wish to cancel the REPEAT, enter an END command.

Control data

The name of the stored function (INTRO, FILL, etc.) is displayed. You can press the **DELETE** key to erase the data which is displayed.

■ TRACK CLEAR

To erase all data from the current track, press the CLR button, and then press the YES button on the confirmation display.

- If you wish to cancel the clear procedure, press the NO button.

Store a rhythm progression

Changes in the rhythm selection and tempo, as well as the intro, fill-ins and the ending, can be stored by measures with the step recording method.

1. On the SEQ MENU display, use the SONG \wedge and \vee buttons to select the song number. Then select RECORD & EDIT.
2. On the RECORD & EDIT display, select STEP RECORD.
 - The display changes to the PART SELECT display.
3. Using the balance buttons below the display, select the track to which the RHYTHM (RHY) part has been assigned.
 - The display changes to the STEP RECORD: RHYTHM input display similar to the following.

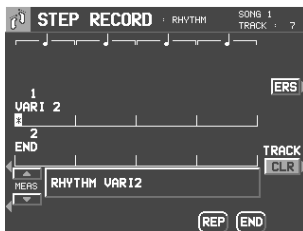

4. Use the MEAS \blacktriangle and \blacktriangledown buttons to go to the measure you wish to record.
5. Store the rhythm data.
 - Data which can be stored:
 - START/STOP**
Changes in the rhythm selection
 - RHYTHM VARIATION 1–4,**
 - COUNT INTRO, INTRO, FILL IN,**
 - ENDING**
Tempo changes
 - Be sure to store the **START/STOP** data in the measure in which the rhythm starts or stops.
 - If you are storing a **COUNT INTRO** or **INTRO**, store this data before the **START/STOP** data.
 - If the tempo is changed, the display changes to the confirmation display. After specifying the desired tempo, Press the YES button to store the specified tempo, or press the NO button to cancel the new tempo value.
6. Repeat steps 4 and 5 to continue storing the rhythm progression.

7. At the end of the rhythm progression, press the END button.
 - If the REP button is pressed instead of the END button, during playback the recorded rhythm progression is repeated.
 - The Keyboard exits the recording mode.

■ Correct the recorded rhythm progression

1. Follow the procedure to select the STEP RECORD: RHYTHM display.
2. Use the MEAS buttons to go to the measure you wish to modify. (The * is highlighted.)
3. Correct the rhythm data.
 - Press the ERS button to erase data at the cursor position.
 - If you wish to cancel the REPEAT, enter an END command.
 - If you select a rhythm with a different time signature, the time signature of all subsequent measures will also change.
 - If data has already been recorded in other tracks, you cannot select a rhythm with a different time signature.

■ TRACK CLEAR

- To erase all data from the current track, press the CLR button, and then press the YES button on the confirmation display.
- If you wish to cancel the clear procedure, press the NO button.

Track Assign

Each **SEQUENCER** part is already assigned to a track number. However, you can use the TRACK ASSIGN function to assign parts to tracks as you wish.

1. On the SEQ MENU display, use the SONG SELECT \wedge and \vee buttons to select the song number. Then select RECORD & EDIT.
2. On the RECORD & EDIT display, select TRACK ASSIGN.
 - The display looks similar to the following.

TRACK ASSIGN					
PRESET			SONG 1		
TRACK ASSIGN	LOCAL CONT	MIDI OUT	TRACK ASSIGN	LOCAL CONT	MIDI OUT
TR 1 RIGHT1	ON	ON	TR 9 PART 5	ON	ON
TR 2 RIGHT2	ON	ON	TR 10 PART 6	ON	ON
TR 3 LEFT	ON	ON	TR 11 PART 7	ON	ON
TR 4 PART 4	ON	ON	TR 12 PART 8	ON	ON
TR 5 CHORD	---	---	TR 13 PART 9	ON	ON
TR 6 CONTROL	ON	ON	TR 14 PART 11	ON	ON
TR 7 RHYTHM	ON	ON	TR 15 PART 12	ON	ON
TR 8 DRUMS	ON	ON	TR 15 PART 13	ON	ON

3. Use the TR \blacktriangle and \blacktriangledown buttons to select the track.
4. Use the TRACK ASSIGN \wedge and \vee buttons to select the part for the specified track.
 - When a part other than the CONTROL, APC, CHORD or RHYTHM part is assigned, the track assign procedure is completed at this point.
 - Either the CHORD part or APC part can be assigned to a track, but not both.
 - The CONTROL, APC, CHORD and RHYTHM parts cannot be assigned to more than one track.
 - You can use the ON and OFF buttons for LOCAL CONT. to specify whether or not the sound of the part assigned to this track is generated. Because no sound is generated for this instrument's parts assigned to tracks set to OFF through this procedure, use this setting to generate sound from an external sound source through the MIDI connectors.
 - You can use the MIDI OUT ON and OFF buttons to specify whether or not the data of the part assigned to this track is sent as MIDI data. When set to OFF, the data is not sent, even if MIDI equipment is connected.
5. When assigning the CONTROL, APC, CHORD or RHYTHM part, press the OK button.

■ TRACK ASSIGN PRESETS

A preset track assignment can be selected.

1. On the TRACK ASSIGN display, press the PRESET button.
 - The display looks similar to the following.



2. Use the SONG \wedge and \vee buttons to select the song number for which the preset track assignment will be effective.
 - If ALL is selected, the track assignment is effective for all the songs.
3. Select the track assign mode.
 - INITIAL:
Factory-preset settings.
 - TECHNICS MULTI RECORDING:
The optimum track assignment for multiplex recording.
 - GM MULTI RECORDING:
The optimum track assignment for creating GENERAL MIDI data.
4. Press the OK button.
 - "COMPLETED!" is shown on the display and the selected track assign mode is enabled.
 - You can confirm the track assignment settings on the TRACK ASSIGN display.

Quantize

The QUANTIZE function can correct the timing of your performance after it has been recorded. If the rhythm is slightly out of sync or inexact, it will automatically be corrected to the specified quantize level.

1. On the SEQ MENU display, select RECORD & EDIT.
2. On the RECORD & EDIT display, select QUANTIZE.
 - The display looks similar to the following.

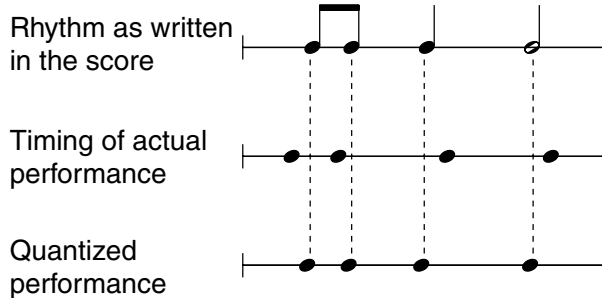

3. Use the TRACK \wedge and \vee buttons to specify the track number.
 - You cannot select the track for the CONTROL, RHYTHM or CHORD part.
 - If ALL is selected, all the tracks are quantized.
4. Use the FIRST MEAS \wedge and \vee buttons to specify the start point (measure number).
5. Use the LAST MEAS \wedge and \vee buttons to specify the end point (measure number).
6. Use the VALUE \wedge and \vee buttons to specify the quantize level.
 - Select from ♩, ♪, ♫, ♫₃, ♫₃, ♫₃, ♫₃. (A 3 denotes a triplet-type note.)

7. Use the STRENGTH \wedge and \vee buttons to select the amount of quantize (%).
 - 100% is a convenient setting. When set to 100%, the performance data is quantized exactly to the level specified for the VALUE (“just”). For example, at 50%, the data is quantized to a point that is half that of the just level. By this setting, you can attain an effect that is very slightly off-beat from the rhythm.

8. Use the WINDOW \wedge and \vee buttons to specify the range (%) affected by the quantize setting.
 - With the increment set to 100 for the VALUE, at a + setting, data close to the just point is corrected, and at a – setting, data far from the just point is corrected. For example, if set to –30% the quantize function affects data far from the just point, and if set to +30% the quantize function affects data close to the just point. +100% is usually a convenient setting.
 - The +100% setting and the –100% setting are the same.

Example: When VALUE is set to ♩

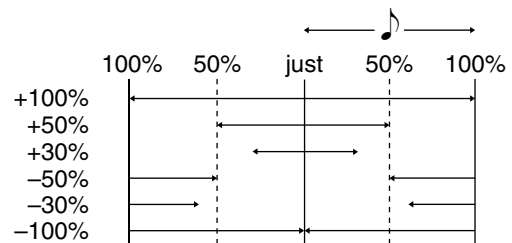

9. Press the OK button.
 - The confirmation display appears. Press the YES button to execute the function, or press the NO button to cancel the function.

Song Clear

Erase the recorded contents of all tracks.

1. On the SEQ MENU display, select RECORD & EDIT.
2. On the RECORD & EDIT display, select SONG CLEAR.
 - The display looks similar to the following.

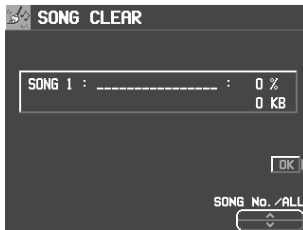

3. Use the SONG No./ALL \wedge and \vee buttons to specify the number of the song to erase.
 - The data size (KB) and the total amount of **SEQUENCER** memory or current song memory used is shown as a percentage (%) to the right of the song name.
 - If ALL is selected, all the songs recorded in the **SEQUENCER** will be erased.

4. Press the OK button.
 - The confirmation display appears. Press the YES button to execute the function, or press the NO button to cancel the function.
 - If the YES button is pressed, "COMPLETED!" appears on the display, the specified songs are erased.

Track Clear

Erase the contents of a specific track.

1. On the SEQ MENU display, select RECORD & EDIT.
2. On the RECORD & EDIT display, select TRACK CLEAR.
 - The display looks similar to the following.



3. Use the balance buttons to select the track or tracks you wish to clear.
 - A "CLR" mark is shown for the selected tracks.

4. Press the OK button.
 - The confirmation display appears. Press the YES button to execute the function, or press the NO button to cancel the function.
 - If the YES button is pressed, the specified tracks are erased.

Note Edit

You can edit performance (NOTE) data on a piano roll display. This differs from the normal STEP RECORD edit procedure, and is a convenient way to check the data for each note.

- Data other than NOTE data cannot be corrected or recorded. To correct or record other types of data, use the STEP RECORD display. (Refer to page 86.)

1. On the SEQ MENU display, select RECORD & EDIT.
2. On the RECORD & EDIT display, select NOTE EDIT.
3. On the PART SELECT display, select a track.
 - The CHORD, RHYTHM and CONTROL tracks cannot be selected.
 - The display looks similar to the following.

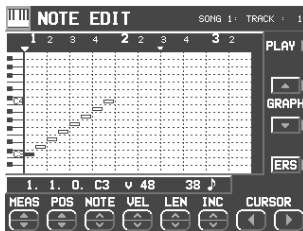

4. Use the MEAS ▲ and ▼ buttons to select the measure you wish to edit.
5. Use the CURSOR ◀ and ▶ buttons to move the cursor (▼) to the point you wish to edit.
 - Recorded performance (NOTE) data is shown as horizontal bars. Data selected for editing is highlighted.
 - You can use the INC ^ and v buttons to change the increment of cursor movement. The resolution can be set at ♩/96. However, if NOTE data is present between increments, the cursor will stop.
 - Use the POS ▲ and ▼ buttons to change the value.
 - Example: 10.2.48 indicates a point in measure 10, beat 2, point 48 (one point is 1/96 of a quarter note [♩]).
 - ■ is shown at the point where the END command is stored.

6. Select the data to edit (it changes to a highlighted horizontal bar). Edit the data.
 - Use the POS ▲ and ▼ buttons to move the cursor, the NOTE ^ and v buttons to change the note number, the VEL ^ and v buttons to change the velocity (how hard the keys are played), and the LEN ^ and v buttons to change the note length (1 = 1/96 of a quarter note [♩]).
 - Use the GRAPH ▲ and ▼ buttons to view a higher or lower section of the keyboard (in one-octave steps).
 - If the ERS button is pressed, the selected NOTE data is erased.

7. Repeat steps 4 to 6 to continue editing.

■ Inserting note data

You can also store note data on this display.

1. Specify the point where the new note data will be stored.
2. Use the LEN ^ and v buttons to specify the note length.
 - Examples of note lengths (♩ = 96)
 - 91: tenuto (95%)
 - 76: normal (80%)
 - 48: staccato (50%)
 - 24: cutting (25%)
3. Play a key on the keyboard to specify the note pitch (NOTE NUMBER) and velocity (how hard the key is played).
4. Repeat steps 1 to 3 to input more note data.

■ CYCLE PLAY

You can aurally check the data you are editing by accessing the CYCLE PLAY display from the NOTE EDIT display.

- If you wish other tracks to be played back, they should be selected beforehand on the SEQUENCER PLAY display. (Refer to page 81.)

1. On the NOTE EDIT display, press the PLAY button.
- The display looks similar to the following.



2. Use the START MEASURE \wedge and \vee buttons to select the beginning playback measure.
3. Use the END MEASURE \wedge and \vee buttons to select the last playback measure.

4. Press the **START/STOP** button.
 - Cycle playback of the specified measures begins.
 - If the SOLO button is turned on, playback changes to that of the recording track only. If it is turned off, all the tracks specified on the SEQUENCER PLAY display are played back.
5. To stop cycle playback, press the **START/STOP** button again.
 - During playback stop, if the **SEQUENCER RESET (FILL IN 1)** button is pressed, the **SEQUENCER** returns to the measure number specified in step 2. If the **SEQUENCER RESET** button is pressed again, the **SEQUENCER** returns to measure 1.

Drum Edit

The DRUMS part can be edited on a specialized display. This differs from the normal STEP RECORD edit procedure, and is a convenient way to check the data for each note.

1. On the SEQ MENU display, select RECORD & EDIT.
2. On the RECORD & EDIT display, select DRUM EDIT.
3. On the PART SELECT display, select the track for the DRUMS part.
 - The CHORD, RHYTHM and CONTROL tracks cannot be selected.
 - The display looks similar to the following.

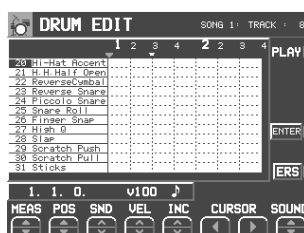

4. Use the SOUND \wedge and \vee buttons to select the percussion instrument you wish to edit.
 - The number to the left of the instrument name is its MIDI NOTE NUMBER in the Technics arrangement.
 - If sounds other than percussion instrument sounds are assigned, they are not displayed.
5. Use the MEAS \blacktriangle and \blacktriangledown buttons to select the measure you wish to edit.
6. Use the CURSOR \blacktriangleleft and \blacktriangleright buttons to move the cursor (\blacktriangledown) to the point you wish to edit.
 - Recorded performance data is shown as vertical bars. Data selected for editing is highlighted.
 - You can use the INC \wedge and \vee buttons to change the increment of cursor movement. The resolution can be set at $\text{♩}/96$. However, if NOTE data is present between increments, the cursor will stop.
 - Use the POS \blacktriangle and \blacktriangledown buttons to change the value.

(Continued on the next page)

Example: 10.2.48 indicates a point in measure 10, beat 2, point 48 (one point is 1/96 of a quarter note [♪]).

- **▬** is shown at the point where the END command is stored.
7. Select the data to edit (it changes to a long bar). Edit the data.
 - Use the POS ▲ and ▼ buttons to move the cursor, the SND ▲ and ▼ buttons to change the percussion instrument sound, and the VEL ▲ and ▼ buttons to change the velocity (how hard the keys are played).
 - If the ERS button is pressed, the selected NOTE data is erased.
 8. Repeat steps 4 to 7 to continue editing.

■ Inserting DRUMS data

You can also store DRUMS data on this display.

1. Specify the point where the new note data will be stored.
2. Use the VEL ▲ and ▼ buttons to specify the velocity (how hard the key is played).
3. Press the ENTER button to store the data.
 - Instead of the ENTER button, you can store data (including velocity data) by playing the keyboard. In this case, the instrument is that specified on the display, regardless of which key is played.
4. Repeat steps 1 to 3 to input more DRUMS data.

■ CYCLE PLAY

You can aurally check the data you are editing by accessing the CYCLE PLAY display from the DRUM EDIT display.

- The procedure is the same as for NOTE EDIT.
- If you wish other tracks to be played back, they should be selected beforehand on the SEQUENCER PLAY display. (Refer to page 81.)

Copy and paste the recorded data

You can copy and paste specific portions of the recorded data.

Select the function

1. On the SEQ MENU display, use the SONG SELECT \wedge and \vee buttons to select the number of the song. Then select COPY & PASTE.
 - The display looks similar to the following.



2. On the COPY & PASTE display, select a function.
3. Perform the editing procedures. (See below.)
 - During the editing procedure, if the indicator for the **TEMPO/PROGRAM** is lit, you can use the **TEMPO/PROGRAM** for the editing function.

SONG COPY

Copy all the recording data of a song to a specific song memory.



1. On the FROM side, use the SONG \wedge and \vee buttons to select the song number you wish to copy from.
2. On the TO side, use the SONG \wedge and \vee buttons to select the song number to copy to.
3. Press the OK button.
 - The confirmation display appears. Press the YES button to execute the function, or press the NO button to cancel the function.

TRACK COPY

Copy the recorded data from specific tracks of a song.

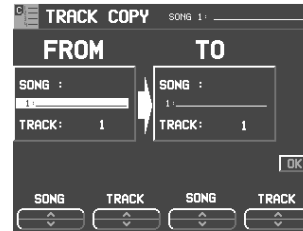

1. Specify the track you wish to copy from.
 - On the FROM side, use the SONG \wedge and \vee buttons and TRACK \wedge and \vee buttons to specify a track.
 - If ALL is selected, all the tracks of the specified song number will be copied.
2. Specify the track you wish to copy to (TO side).
3. Press the OK button.
 - The confirmation display appears. Press the YES button to execute the function, or press the NO button to cancel the function.
 - The track assignment settings are also copied. Note that in some cases, the CONTROL, RHYTHM and CHORD part data in the destination tracks may be lost.

TRACK MERGE

Merge the recorded contents of two tracks (source tracks) and store the merged contents in a third track (destination track).

- When the TRACK MERGE function is executed, the data is erased from the two source tracks.

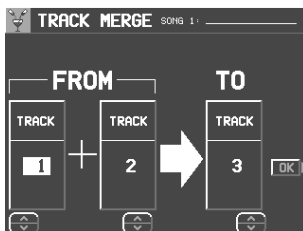

1. Select the two source tracks (FROM).
 - On the FROM side, use the TRACK ^ and v buttons to select the two source tracks.
 - You cannot select the track to which the CONTROL, RHYTHM or CHORD part has been assigned.
 - If the part assigned to the left source track ("left" meaning its position on the TRACK MERGE display) is different from the part assigned to the right source track, when the parts are merged in the destination track, the new track is assigned the same part as the left track.
2. Select the destination track (TO).
 - Use the TRACK ^ and v buttons to the right of the display to specify the track number.
3. Press the OK button.
 - The confirmation display appears. Press the YES button to execute the function, or press the NO button to cancel the function.

MEASURE COPY

Copy recorded data of specified measures to a specified point.

- On the destination track, the new data replaces the current measure contents.

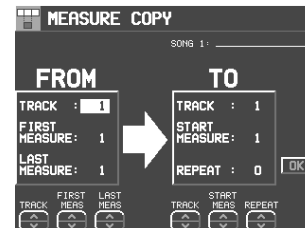

1. Specify the measures you wish to copy from the source track (FROM).
 - On the FROM side, specify the settings with the corresponding buttons.

TRACK:
Specify the track number you wish to copy the measures from.

 - You cannot select the track for the RHYTHM part or CHORD part in which a repeat command has been stored.
 - If ALL is selected, the specified measures are copied to all tracks at the same time.

FIRST MEAS:
Specify the first measure to copy.

LAST MEAS:
Specify the last measure to copy.
2. Specify where you wish to copy the selected measures to.
 - On the TO side, specify the settings with the corresponding buttons.

TRACK:
Specify the track number you wish to copy to.

 - Measures in a track for the CONTROL, RHYTHM or CHORD part can be copied only to the same track.

START MEAS:
Specify the start point to copy the selected measures to.

REPEAT:
Specify the number of times the selected measures are to be repeated.
3. Press the OK button.
 - The confirmation display appears. Press the YES button to execute the function, or press the NO button to cancel the function.
 - Note that if the END command is included in the source data, it is also copied. Any data following the END command is not copied.

MEASURE ERASE

Erase the recorded contents of specific measures. You can also specify which type of data is to be erased.

- Note that only the contents of the measures are erased, not the measures themselves; the length of the performance remains the same.



1. Use the TRACK \wedge and \vee buttons to specify the track number.
 - This function does not work for the RHYTHM part or CHORD part in which a repeat command has been stored.
 - If ALL is selected, data is erased from the specified measures of all the tracks at one time.
2. Use the FIRST MEAS \wedge and \vee buttons to specify the start point (measure number).
3. Use the LAST MEAS \wedge and \vee buttons to specify the end point (measure number).
4. Use the ERASE DATA \wedge and \vee buttons to specify the type of data to be erased.

ALL:

All data is erased.

NOTE:

Only note data is erased.

CONTROL:

Only control data (volume, effect and other panel settings as well as selection changes) is erased.

5. Press the OK button.
 - The confirmation display appears. Press the YES button to execute the function, or press the NO button to cancel the function.

MEASURE DELETE

Delete specified measures from a track.

- The length of the performance accordingly decreases by the number of deleted measures.



1. Use the TRACK \wedge and \vee buttons to select the track from which measures are to be deleted.
 - This function does not work for the CHORD or RHYTHM track in which the repeat function has been stored.
 - If ALL is selected, the specified measures are deleted from all the tracks at one time.
2. Use the FIRST MEAS \wedge and \vee buttons, to specify the first measure to delete.
3. Use the LAST MEAS \wedge and \vee buttons to specify the last measure to delete.
4. Press the OK button.
 - The confirmation display appears. Press the YES button to execute the function, or press the NO button to cancel the function.

MEASURE INSERT

Insert specified measures at a specified point.

- The length of the performance accordingly increases by the number of inserted measures.

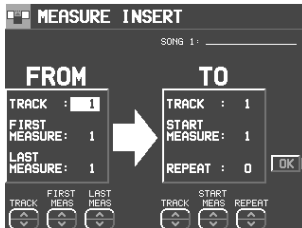

1. Specify the measures you wish to copy from the source track.
 - On the FROM side, specify the settings with the corresponding buttons.

TRACK:

Specify the track number you wish to copy the measures from.

- This function does not work for the CHORD or RHYTHM track in which the repeat function has been stored.
- If ALL is selected, the measures are inserted in all tracks at the same time.

FIRST MEASURE:

Specify the first measure to copy.

LAST MEASURE:

Specify the last measure to copy.

2. Specify where you wish to insert the selected measures.
 - On the TO side, specify the settings with the corresponding buttons.

TRACK:

Specify the track number.

- Measures from the CHORD, RHYTHM or CONTROL track can only be inserted in the same track.

START MEASURE:

Specify the start point to insert the selected measures.

REPEAT:

Specify the number of times the selected measures are to be repeated.

3. Press the OK button.
 - The confirmation display appears. Press the YES button to execute the function, or press the NO button to cancel the function.
 - Note that if the END command is included in the source data, it is also inserted. Any data following the END command is not inserted.

APC TO SMF CONVERT

This function converts data to Standard MIDI File (SMF) format, allowing you to play back song data created using this instrument's automatic accompaniment and/or PERFORMANCE PADS on an external sequencer or sound generator.



1. Use the TR ▲ and ▼ buttons to select the track you wish to convert.
 - In the PART column, the part name currently assigned is shown.
 - In the DATA column, a check mark (√) indicates a track in which data is stored.
 - Tracks in which RHYTHM, CONTROL, APC and CHORD parts are stored cannot be selected (--- is shown).
2. Use the APC/PAD ^ and v buttons to select the parts you wish to convert.
 - Parts that are set to OFF will not be converted.
3. Press the CONVERT button.
 - Note that after the conversion, the APC/CHORD part data is cleared; if necessary, save this data beforehand.
 - A confirmation display appears. Press EXECUTE to continue with the conversion, or press the CANCEL button if you wish to discontinue.
 - After the EXECUTE button is pressed, the conversion begins. Conversion takes the same length of time as playback.
 - If you wish to discontinue the conversion process midway, press the ABORT button.

Changing the note position etc. of the recorded data

You can change the note pitch and position etc. of recorded data.

Select the function

1. On the SEQ MENU display, use the SONG \wedge and \vee buttons to select the number of the song. Then select RANGE EDIT.
- The display looks similar to the following.

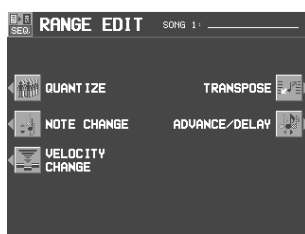

2. On the RANGE EDIT display, select a function.
3. Perform the editing procedures. (See below.)
- During the editing procedure, if the indicator for the **TEMPO/PROGRAM** is lit, you can use the **TEMPO/PROGRAM** for the editing function.

NOTE CHANGE

Change of pitch of specified notes.

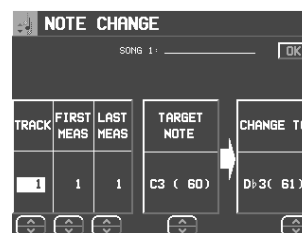

1. Use the TRACK \wedge and \vee buttons to select the track you wish to edit.
 - You cannot select the track for the CONTROL, RHYTHM or CHORD part.
 - If ALL is selected, all tracks will be edited.
2. Use the FIRST MEAS \wedge and \vee buttons to specify the start point (measure number) of the note change.
3. Use the LAST MEAS \wedge and \vee buttons to specify the end point (measure number) of the note change.
4. Use the TARGET NOTE \wedge and \vee buttons to specify the pitch of the note you wish to change.
 - The number next to the note name is its note number.
5. Use the CHANGE TO \wedge and \vee buttons to specify the pitch you wish to change to.
6. Press the OK button.
 - The confirmation display appears. Press the YES button to execute the function, or press the NO button to cancel the function.

VELOCITY CHANGE

Modify the recorded velocity in specific measures of specific tracks.



1. Use the TRACK \wedge and \vee buttons to select the track you wish to edit.
 - You cannot select the track for the CONTROL, RHYTHM or CHORD part.
 - If ALL is selected, all tracks will be edited.
2. Use the FIRST MEAS \wedge and \vee buttons to specify the start point (measure number) of the velocity change.
3. Use the LAST MEAS \wedge and \vee buttons to specify the end point (measure number) of the velocity change.
4. Use the VELOCITY \wedge and \vee buttons to specify the change in velocity.
 - The value you select will be added to or deleted from the current velocity.
5. Press the OK button.
 - The confirmation display appears. Press the YES button to execute the function, or press the NO button to cancel the function.

TRANPOSE

Change of key of specific measures of specific tracks.



1. Use the TRACK \wedge and \vee buttons to select the track you wish to edit.
 - You cannot select the track for the CONTROL, RHYTHM or CHORD part.
 - If ALL is selected, all tracks will be edited.
2. Use the FIRST MEAS \wedge and \vee buttons to specify the start point (measure number) of the transpose.
3. Use the LAST MEAS \wedge and \vee buttons to specify the end point (measure number) of the transpose.
4. Use the TRANPOSE \wedge and \vee buttons to specify the change in pitch.
 - Increments are in semitones. A value of 12 is one octave. A $-$ value lowers the pitch, and a $+$ value raises it.
5. Press the OK button.
 - The confirmation display appears. Press the YES button to execute the function, or press the NO button to cancel the function.

ADVANCE/DELAY

Speed up or delay the sound production of specified performance data.



- Use the TRACK \wedge and \vee buttons to select the track you wish to edit.
 - You cannot select the track for the CONTROL, RHYTHM or CHORD part.
 - If ALL is selected, all tracks will be edited.
- Use the FIRST MEAS \wedge and \vee buttons to specify the start point (measure number) of the change.

- Use the LAST MEAS \wedge and \vee buttons to specify the end point (measure number) of the change.
- Use the ADVANCE/DELAY \wedge and \vee buttons to accelerate or delay the timing of the sound production (–96 to +96).
 - A + value causes the notes to sound later, and a – value causes the notes to sound earlier.
- Press the OK button.
 - The confirmation display appears. Press the YES button to execute the function, or press the NO button to cancel the function.

SD Audio Synchro (KN2600)

The sound data on the SD card in the SD slot can be synchronized with SEQUENCER playback.

- On the SEQ MENU display, press the SD AUDIO SYNCHRO button.



- Use the PLAYLIST NUMBER \wedge and \vee buttons to select the number you wish to synchronize from the PLAYLIST.
- Play back the SEQUENCER song. (Refer to page 81.)

<Note>

When creating SEQUENCER data that is synchronized with SD AUDIO data, the environment in which the SD AUDIO data was created may result in data that is slightly out of sync with the SEQUENCER. When this occurs use the TEMPO ADJUST feature to compensate for this timing discrepancy (–127 to +127).

Part V Composer

Outline of the Composer

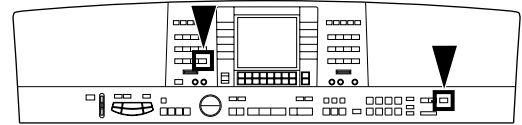

The **COMPOSER** enables you to create your own accompaniment patterns. A pattern is comprised of 8 parts: **DRUMS 1, 2**, **BASS** and **ACCOMP1–5** parts. These parts would form the backing of a song.

Rhythm components which can be stored

Different **INTRO 1, 2**, **VARIATION 1 to 4**, **FILL IN 1, 2** patterns can be created for each **MEMORY (A, B, C)**.

- Each **VARIATION** is made of a **PATTERN**, **FILL 1** and **FILL 2**.
- A **Maj** (major) and **Min** (minor) pattern is available for each of the **INTRO** and **ENDING 1** and **2**.

INTRO	VARI 1	VARI 2	VARI 3	VARI 4	ENDING
1 Maj 1 Min 2 Maj 2 Min	PATTERN FILL IN 1 FILL IN 2	PATTERN FILL IN 1 FILL IN 2	PATTERN FILL IN 1 FILL IN 2	PATTERN FILL IN 1 FILL IN 2	1 Maj 1 Min 2 Maj 2 Min

Memory capacity

Expressed in terms of notes, the total number of notes which can be stored in all the **COMPOSER** memories is about 13,000. The remaining memory available for recording is shown on the recording display as a percentage (%).

- When “Memory full!” appears on the display no more data can be stored in the **COMPOSER**.

■ MEMORY

Because the contents of the **MEMORY** are erased after the power is turned off, you should save the data on disks/SD cards if you wish to keep it. (Refer to pages 125, 140.)

COMPOSER menu

1. Press the **PROGRAM MENUS** button to turn it on.
- The display looks similar to the following.

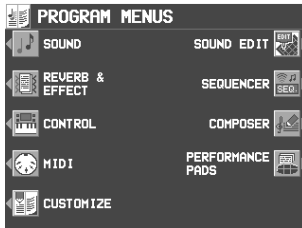

2. Select **COMPOSER**.
- The display looks similar to the following.

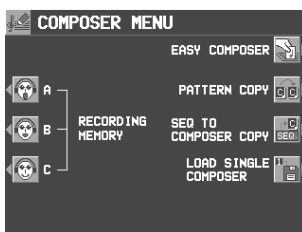

Summary of the COMPOSER menu items

RECORDING MEMORY-A

Create a memory in the **MEMORY A** bank.

RECORDING MEMORY-B

Create a memory in the **MEMORY B** bank.

RECORDING MEMORY-C

Create a memory in the **MEMORY C** bank.

EASY COMPOSER (page 106)

Create a rhythm pattern with a simplified procedure.

PATTERN COPY (page 115)

Copy a rhythm pattern into a memory.

SEQ TO COMPOSER COPY (page 116)

Copy recorded data in the **SEQUENCER** to the **COMPOSER**.

LOAD SINGLE COMPOSER

Recall the desired **COMPOSER** data from data saved on a disk/card. This procedure is the same as when **COMPOSER** is selected for **SINGLE LOAD**. (Refer to pages 121, 134.)

Three ways to record in the COMPOSER

There are three ways to create and record a rhythm.

■ Simple recording method (page 106)

Use **EASY COMPOSER** to quickly create a unique rhythm just by selecting a pattern for each part.

■ Create a completely new rhythm (page 106)

Compose all the parts of a completely new rhythm from scratch.

- You can use either realtime recording or step record for any part of the recording.

■ Pattern Copy (page 115)

Copy a preset rhythm or **SEQUENCER** data to a **COMPOSER** memory, edit it as you like, and then store it as a new rhythm.

Simple recording method

With EASY COMPOSER you can easily create a unique rhythm pattern by selecting a different style for each part of the rhythm.

1. On the COMPOSER MENU display, select EASY COMPOSER.
 - The display looks similar to the following.



2. Use the MEM \wedge and \vee buttons to select the memory in which to record your rhythm.
 - Select from A-vari 1 to 4, B-vari 1 to 4 and C-vari 1 to 4.
3. Use the PART \blacktriangle and \blacktriangledown buttons to select the part.
 - In the EASY COMPOSER, the new rhythm pattern is divided into 9 parts, to each of which a style and variation is assigned.
4. Use the STYLE \wedge and \vee buttons to select a style.

5. Use the VARI \wedge and \vee buttons to select the variation number.
 - The number of variations differs depending on the selected style.
 - A part which is set to OFF does not sound. Note that the “BsDrum&Snare” part cannot be set to OFF.

6. Repeat steps 3 to 5 to select styles for the other parts.

7. Press the SET button.
 - The rhythm pattern is played back.
 - If you are not satisfied with the rhythm pattern, repeat steps 3 to 7.
 - If you wish to correct the sounds or phrases in your rhythm pattern, press the EDIT button. The display changes to the recording display. (Refer to page 108.)
 - For playback, refer to page 111.

Create a completely new rhythm

Clear the memories and compose a completely new rhythm from scratch.

- You can also use this method when copying a pattern from a preset rhythm or the **SEQUENCER**.

Prepare to record

1. On the COMPOSER MENU display, select a memory in which to record (RECORDING MEMORY A, B, or C).
 - The display looks similar to the following.



2. Use the buttons below the display to select the pattern you want to create.
 - If the MEM CLR button is pressed, all the current contents of the MEMORY (A/B/C) are erased (a confirmation display appears).
 - You can press the NAMING button and assign a name to the MEMORY.



- To assign a name to each VARIATION, press the VARI button and select a number.
- On the RECORD MEMORY display, press the OK button.
 - The display looks similar to the following.



- Press the CLEAR THE ENTIRE PATTERN button.
 - The display looks similar to the following.



- Press the YES button.
 - All the data for the selected pattern is erased.
- Press the MEASURE SETTING button.

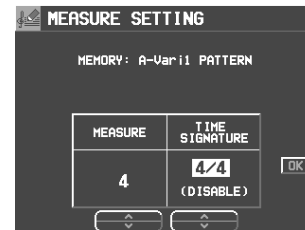

- Use the MEASURE ^ and v buttons to specify the number of measures in your new rhythm pattern (1 to 16).
- Use the TIME SIGNATURE ^ and v buttons to specify the meter of the pattern (1/4 to 8/4).
 - When the settings for the MEASURE and TIME SIGNATURE of the INTRO or ENDING patterns are changed, the Maj and Min settings change at the same time.
- Press the OK button.
- Press the EXIT button.

KEY SETTING

Set the key and chord in which you wish the recorded pattern to be played. If the recorded performance is played in a key or chord different from this setting, the automatic accompaniment will not be able to distinguish the correct chord.

- On the RECORDING display press the KEY SETTING button.
 - The display looks similar to the following.

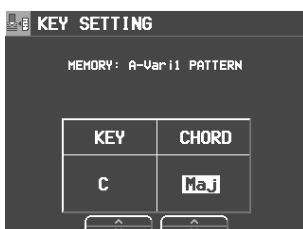

- Use the KEY ^ and v buttons to set the key. Use the CHORD ^ and v buttons to set the chord type (Maj/Min).
- When you have finished making the settings, press the EXIT button.

Recording procedure



1. In the START RECORDING area on the display, select the rhythm part you want to record first.

BAS: **BASS**

AC1–5: **ACCOMP 1–5**

DR1, 2: **DRUMS 1, 2**

- The metronome sound starts and the display looks similar to the following.



2. Adjust the tempo.

- The tempo is shown on the display as $\text{♩} = 120$.
- The tempo can be freely adjusted when you play back the rhythm pattern, so record at the tempo which is easiest for you to play.

3. Select the sound.

- For the **DRUMS** part, only sounds from the **DRUM KITS** sound group can be selected.
- For the **ACCOMP** and **BASS** parts, select sounds from groups other than the **DIGITAL DRAWBAR** sound groups.
- The sounds marked with # represent special guitar performances and changing them to other sounds may result in an unnatural, awkward sound expression.

4. Record the part.



- The specified number of measures are repeatedly played back, during which time any newly played notes are added to those already recorded. The current measure number is shown on the display as “MEASURE=”.

- Record the performance in C major for correct chord progressions during playback. Follow the **KEY SETTING** procedure if you wish to record the performance in a different scale.

- **PITCH BEND, MODULATION** (KN2600) (except for the **DRUMS** part) effects are also recorded.
- The **SUSTAIN ON/OFF** is also stored (except for the **DRUMS** part).

■ Button functions

PART BALANCE:

Adjust the volume of each part on the **PART BALANCE** display. (These settings are not recorded.)

PART SETTING:

You can make detailed settings for each part. (Refer to page 110.)

STEP RECORD:

Change to the **STEP RECORD** mode. (Refer to page 111.)

SOLO:

Mute all parts except the part which is currently being recorded.

- A **MUTE** mark is shown for the other parts on the display.
- To turn off the **SOLO** function, press this button again.

PART CLR:

Erase all recorded contents of the currently selected part.

NOTE CLR:

Data is erased one note or one percussion instrument (**DRUMS** part) sound at a time.

- Hold and press this button, and press the keyboard key that corresponds to the note or percussion instrument (**DRUMS** part) sound you wish to erase.

ALL ERAS:

The performance recorded in the selected part is erased for as long as this button is pressed.

QUANTIZE:

Smooth out any unevenness in the timing of your performance.

- Before recording, select the note value for the desired quantize level. (The quantize level is shown on the display as **QUANTIZE=**.)

KEY IN CHORD MODIFY <PAGE 2/2> (except for INTRO, ENDING, DRUMS):

Use the GROUP and TYPE \wedge and \vee buttons to select the type of pattern progression.

- This setting is for the sound that is going to be recorded from this time.
5. Use the buttons below the display to switch to a different recording part, and proceed to record each part in turn.
 6. When you have finished recording the rhythm, turn off the **PROGRAM MENUS** button.

Chord Modify Change

For data that has already been recorded, you can select the type of pattern progression for the bass and accomp parts.

- This function cannot be used for the INTRO and ENDING patterns.

1. On the RECORDING display, press the CHORD MODIFY CHANGE button.
- The display looks similar to the following.

PART	GROUP	MODIFY TYPE	FUNCTION
BASS	Melody	Basic	KEEP
ACCOMP1	Melody	In 7th G+B	KEEP
ACCOMP2	Melody	In 7th G+B	KEEP
ACCOMP3	Melody	In 7th G+B	KEEP
ACCOMP4	Melody	In 7th G+B	KEEP
ACCOMP5	Melody	In 7th G+B	KEEP

2. Use the PART \blacktriangle and \blacktriangledown buttons to select the part you wish to set.
3. Use the GROUP and MODIFY TYPE \wedge and \vee buttons to select the corresponding progression type.
 - If a progression type for which the note name is displayed (in C key) was selected for the chord group, played notes which are not displayed are changed to notes which are displayed.
4. Use the FUNCTION \wedge and \vee buttons to enable or disable the function.
 - KEEP: No change.
 - CHANGE: The change is enabled.
5. When you have finished making the settings for each part, press the OK button.
6. Press the **EXIT** button.

Part Setting

You can make detailed settings for each part.

- On the REALTIME RECORDING display, press the PART SETTING button.
 - The settings comprise 3 pages of the display. Use the **PAGE** buttons to switch pages.
- Use the PART ▲ and ▼ buttons to select a part.
- Use the ^ and v buttons to set the corresponding item.

<PAGE 1>

PART	PITCH POINT	SOUND	DIGI EFF
DRUM1	---	Standard Kit2	---
DRUM2	---	Standard Kit1	---
BASS	Ab	Electric Bass	(SOUND)
ACCOMP1	Ab	Pop E.P.	(SOUND)
ACCOMP2	Ab	Bright Solid Gtr	(SOUND)
ACCOMP3	Ab	Piano	(SOUND)
ACCOMP4	Ab	Piano	(SOUND)
ACCOMP5	Ab	Piano	(SOUND)

PITCH POINT:

The pitch at which the pattern progression sound is lowered by one octave.

- When the root note of the specified chord is higher than the set pitch point, the pitch of that part is automatically lowered by one octave, thus avoiding an unnaturally high accompaniment pitch.
- This is effective only for the part for which the Melody group was selected in CHORD MODIFY CHANGE.

SOUND:

Use the panel buttons to select the sound.

DIGI EFF:

Set the **DIGITAL EFFECT** to on or off.

- (SOUND) is the initialized setting of the sound.

<PAGE 2>

PART	BALANCE	PAN	REV	CHO	BEND RANGE
DRUM1	-15	---	47	0	12
DRUM2	0	---	0	0	12
BASS	-25	CENTER	0	0	12
ACCOMP1	-27	LEFT 53	55	0	12
ACCOMP2	-33	RIGHT 52	70	0	12
ACCOMP3	0	CENTER	55	0	12
ACCOMP4	0	CENTER	55	0	12
ACCOMP5	0	CENTER	55	0	12

BALANCE:

Adjust the volume balance.

PAN:

Adjust the stereo balance of each part (LEFT 64 – CENTER – RIGHT 63).

- At “LEFT 64”, the sound is all the way to the left, at “RIGHT 63” all the way to the right. The center point is CENTER.

REV:

Depth of the **REVERB** (0 to 127).

CHO:

Depth of the **CHORUS** (0 to 127).

BEND RANGE:

Adjust the range of pitch change when the **PITCH BEND** wheel is operated (0 to 12).

<PAGE 3>

PART	EQ-Hi Fc	EQ-Hi Gain	EQ-Low Fc	EQ-Low Gain
DRUM1	10kHz	+0.0	800Hz	-2.0
DRUM2	10kHz	+0.0	100Hz	+0.0
BASS	10kHz	+0.0	800Hz	-2.0
ACCOMP1	10kHz	-0.5	1kHz	-1.0
ACCOMP2	10kHz	+0.0	1kHz	-1.0
ACCOMP3	10kHz	+0.0	100Hz	+0.0
ACCOMP4	10kHz	+0.0	100Hz	+0.0
ACCOMP5	10kHz	+0.0	100Hz	+0.0

EQ-Hi:

Sound correction in the high range.

- Use the FC ^ and v buttons to adjust the standard frequency. Use the GAIN ^ and v buttons to set the ratio of change.

EQ-Low:

Sound correction in the low range.

- Use the FC ^ and v buttons to adjust the standard frequency. Use the GAIN ^ and v buttons to set the ratio of change.

Playback

1. In the **RHYTHM GROUP** section, press the **MEMORY** button.

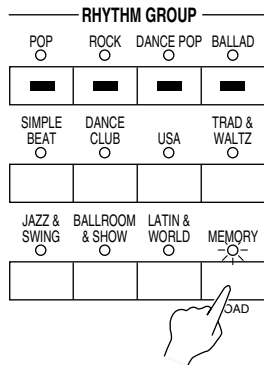

- The display looks similar to the following.



2. Select the desired memory (A/B/C).
3. Use the **VARIATION** buttons to select a variation.
4. Press the **START/STOP** button.
 - The **DRUMS** part begins to play back.
 - The **BASS** and **ACCOMP** parts are played back when you use the **AUTO PLAY CHORD**.

Step Record

Use **STEP RECORD** to store the notes one-by-one on the display. This is a convenient way to store complicated patterns that are difficult to play.

Recording procedure

1. While you are recording, press the **STEP RECORD** button.
 - The display changes to the **STEP RECORD** display similar to the following.

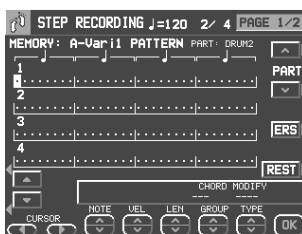

2. Use the **CURSOR** buttons to move the cursor to the note position you are going to store.
 - Each dot represents one-eighth of a quarter-note (a thirty-second note).
 - When storing triplets, it may not be possible to match the timing exactly with the 1/32-note steps. However, if you select triplet-type notes for the note length (**LENGTH**) in step 4 below, the timing is automatically corrected.

3. Use the **PAGE** button to access the **PAGE 2/2** display.



4. Use the left **LENGTH** buttons to specify the note value. Select from $\frac{3}{8}$, $\frac{2}{8}$, $\frac{1}{8}$, $\frac{1}{4}$, $\frac{3}{16}$, $\frac{1}{16}$, $\frac{3}{32}$, $\frac{1}{32}$, $\frac{1}{64}$, $\frac{1}{128}$ × 2 to 4. (A 3 denotes a triplet-type note.)
 - For note values other than these, use the right **LENGTH** buttons to specify the note value to be added to that which you specified with the left buttons.

Example: To record a dotted quarter-note (♩.)



(Continued on the next page)

5. Use the PHRS \wedge and \vee buttons to specify the actual length of the produced sound for the desired legato or staccato effect.

TENU (tenuto):	Sound is produced for 95% of the note length.
NORM (normal):	80%
STAC (staccato):	50%
CUTT (cutting):	25%

6. Specify the pitch and velocity of the note by playing the keyboard.

- The dot on the display where the note is stored changes to a * mark.
- When recording chords, you can store multiple notes at one position.

REST: To store a rest, after specifying the note LENGTH, press the REST button.

- Positions at which nothing is stored are read as rests.

ERS: If you make a mistake, move the cursor to the error, and after displaying the data you wish to erase, press the ERS button.

7. Repeat steps 2 through 6 to continue storing notes.

- To record a different part, use the PART \wedge and \vee buttons to select another part.
- The NOTE, VELOCITY, LENGTH, CHORD MODIFY and CONTROL can be revised later. Press the OK button after the revision.
- You can easily switch between the REALTIME mode and the STEP mode any time during recording. To return to the realtime recording display during the STEP RECORD mode, press the **EXIT** button.

Measure Edit

You can edit the recorded data one measure at a time.

Select the function you wish to edit.

1. During recording, press the MEASURE EDIT button.
- The display looks similar to the following.

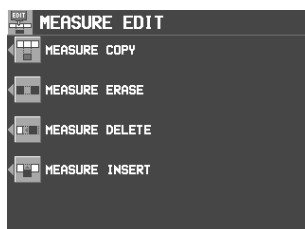

2. Select the function.

3. Follow the procedure to edit the function (see below).

- Only the contents of the same pattern can be edited.

MEASURE COPY

Copy recorded data of specified measures to a specified point.

- On the destination track, the new data replaces the current measure contents.

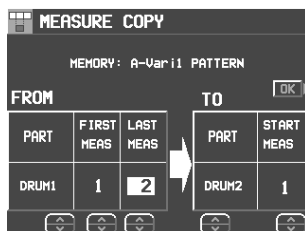

- Specify the measures you wish to copy from the source track (FROM).
- On the FROM side, specify the settings with the corresponding buttons.

PART:

Select the part to copy from. (If ALL is selected, all parts are copied.)

FIRST MEASURE:

Specify the first measure to copy.

LAST MEASURE:

Specify the last measure to copy.

- Specify where you wish to copy the selected measures to.
- On the TO side, specify the settings with the corresponding buttons.

PART:

Select the part to copy to.

START MEASURE:

Specify the start point to copy the selected measures to.

- Press the OK button.
- The confirmation display appears. Press the YES button to execute the function, or press the NO button to cancel the function.
- If the FROM and TO parts are the same and the FROM and TO measures overlap, copy is not possible.

MEASURE ERASE

Erase the recorded contents of specific measures.

- Note that only the contents of the measures are erased, not the measures themselves; the length of the performance remains the same.

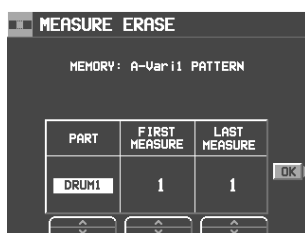

- Use the PART \wedge and \vee buttons to specify the part.
- If ALL is selected, data is erased from the specified measures of all the parts at one time.
- Use the FIRST MEASURE \wedge and \vee buttons to specify the start point (measure number).

- Use the LAST MEASURE \wedge and \vee buttons to specify the end point (measure number).
- Press the OK button.
- The confirmation display appears. Press the YES button to execute the function, or press the NO button to cancel the function.

MEASURE DELETE

Delete specified measures from all parts at once.

- The length of the performance accordingly decreases by the number of deleted measures.

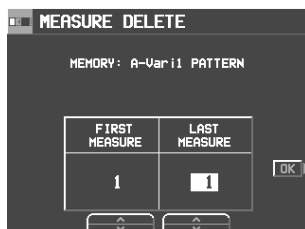

1. Use the FIRST MEASURE \wedge and \vee buttons, to specify the first measure to delete.
2. Use the LAST MEASURE \wedge and \vee buttons to specify the last measure to delete.
 - One measure is the smallest unit that can be deleted.
3. Press the OK button.
 - The confirmation display appears. Press the YES button to execute the function, or press the NO button to cancel the function.
 - When the INTRO or ENDING measures are deleted, the Maj and Min data are erased at the same time.

MEASURE INSERT

Insert blank measures at a specified point.

- The length of the performance accordingly increases by the number of inserted measures.

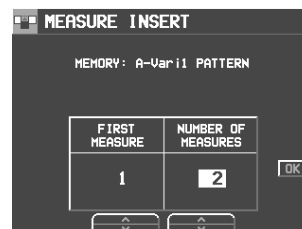

1. Use the FIRST MEASURE button to select the point (measure) where the measures are to be inserted.
2. Use the NUMBER OF MEASURE button to select the number of blank measures to insert.
 - No more than 16 measures total can be inserted.
3. Press the OK button.
 - The confirmation display appears. Press the YES button to execute the function, or press the NO button to cancel the function.
 - The Maj or Min data is inserted in the INTRO and ENDING at the same time.

Pattern Copy

Use this function to copy a pattern from a rhythm or from **SEQUENCER** data.

PATTERN COPY

Copy a rhythm to the **COMPOSER**.

- You can also copy a pattern from the **MEMORY**.

1. On the **COMPOSER MENU** display, select **PATTERN COPY**.

- The display looks similar to the following.

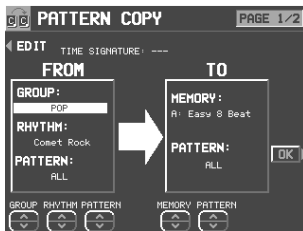

2. Select the pattern you wish to copy.

- In the **FROM** box, specify the settings with the corresponding buttons.

GROUP: Group name
RHYTHM: Rhythm name
PATTERN: Pattern name

- If **ALL** is selected, all the patterns are copied.

3. Select the memory you wish to copy to.

- In the **TO** box, specify the settings with the corresponding buttons.

MEMORY: Memory name (A, B or C)
PATTERN: Pattern name

- If **ALL** is selected, all the patterns are copied.

4. Press the **OK** button.

- When copying has been successfully completed, "COMPLETED!" appears on the display.

- If you wish to use the **COMPOSER** functions to edit the copied data, press the **EDIT** button, and follow the procedure to record a pattern.

■ Copying individual parts

1. Use the **PAGE** ^ and v buttons to select **PAGE 2/2**.

- The display looks similar to the following.

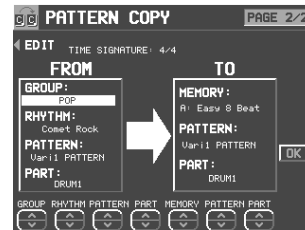

2. On the **FROM** side, use the buttons to specify the part to copy from.

- For the **DRUM** part you can specify the **DRUMS 1** or **2** part; for other parts you can specify a part other than a **DRUMS** part.

3. Specify the destination on the **TO** side to which the part will be copied.

4. Press the **OK** button.

SEQ TO COMPOSER COPY

Data from the **SEQUENCER** can be copied to a **COMPOSER** memory. For example, you can use a rhythm pattern on a song disk as the automatic accompaniment for your own performance.

1. Play back the song you wish to copy from **SEQUENCER** to confirm the tracks, the measures and the time signature you wish to copy.
2. Follow the procedure in “Prepare to record” to prepare the **COMPOSER** memory you will be copying to. (Refer to page 106.)
 - Be sure that time signature setting in the **SEQUENCER** data you are copying from and the time signature in the **COMPOSER** memory you are copying to are the same, or the data will not be copied successfully.
3. On the **COMPOSER MENU** display, select **SEQ TO COMPOSER COPY**.
 - The display looks similar to the following.

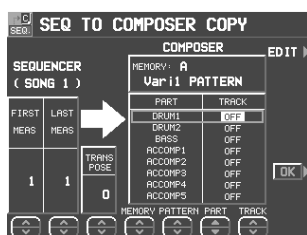

4. Use the **FIRST MEAS** \wedge and \vee buttons to specify the number of the first measure to copy.
5. Use the **LAST MEAS** \wedge and \vee buttons to specify the number of the last measure to copy.
6. Use the **TRANSPOSE** \wedge and \vee buttons to change the key of the copied measures (–24 to +24).
 - Units are in semitones.
7. Use the **MEMORY** \wedge and \vee buttons to specify the **COMPOSER** memory to copy to.
8. Use the **PATTERN** \wedge and \vee buttons to specify the pattern to copy to.

9. For each **COMPOSER** part, specify the **SEQUENCER** track from which to copy data.
 - Use the **PART** \blacktriangle and \blacktriangledown buttons to specify the part name, and the **TRACK** \wedge and \vee buttons to specify the track number.
 - Parts which are set to OFF are blank.
10. Press the **OK** button.
 - “COMPLETED!” is shown on the display.
 - If you wish to use the **COMPOSER** function to edit the copied data, press the **EDIT** button, and follow the procedure to record a pattern.
 - In the case of **INTRO** or **ENDING**, if a measure contains a **Maj** or **Min** command, it is reproduced in the other pattern as well.

Part VI Disk Drive (KN2400)

Outline of the Disk Drive function

The Disk Drive enables you to store recorded and stored data from this instrument's memories on disks, as well as play commercial recorded disks on this instrument.

Internal memory and Disk Drive

The storable internal memory of this instrument as well as the backup time are limited. However, the Disk Drive maximizes your control of data management by allowing you to store (SAVE) this instrument's data on disks, and then to recall (LOAD) it at any time.

- The BACK UP data will not be erased even with the passage of time.

■ The following data can be saved/loaded:

PERFORMANCE

CURRENT PANEL (The current panel settings)
PANEL MEMORY*
SEQUENCER
COMPOSER* (MEMORY contents)
SOUND MEMORY*
PERFORMANCE PADS (USER memories)
EFFECT MEMORY*

BACKUP

MIDI & FAVORITES

- When creating or saving song data, it is recommended that you use the performance data in the PERFORMANCE group.

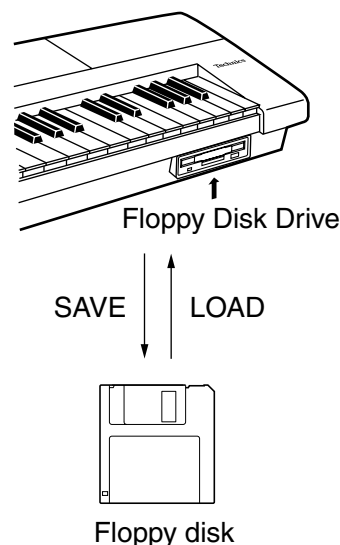

- Instead of using MIDI & FAVORITES as frequently loaded and saved data, it is recommended that you save it with other data as Keyboard backup data.
- A * mark indicates that data can be loaded to and from a specific memory (SINGLE LOAD).
- The **SEQUENCER** contents can be saved in one-song increments (SEQUENCER SONG SAVE).
- Please use 2HD disks to load/save BACKUP data.

Main parts of the Disk Drive

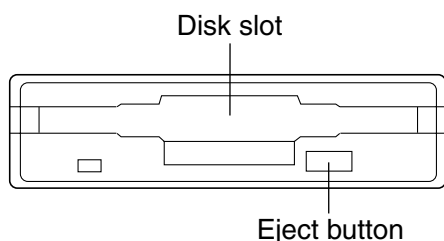

Eject button

Press to remove the disk from the Disk Drive.

- You can use 3.5 inch 2DD (720 KB) or 2HD (1.44 MB) disks; however, 2HD disks formatted as 2DD cannot be used.

Using commercial song disks

Not only disks recorded on this instrument, but also data from commercial song disks can be read on this instrument.

- This instrument accepts the following file formats:

TECHNICS File format
Standard MIDI File format

■ Loading Technics File format disks

Using Technics file format disks allows you load new SOUND EDIT, rhythm & accompaniments, **PANEL MEMORY**, **PERFORMANCE PADS** and Song data into your instrument to expand its potential even further.

■ About Standard MIDI Files

“Standard MIDI File” (SMF) is a standardized data format which makes it possible for music data to be exchanged among different sequencers. Data stored in this format on sequencers of different models can be played back on this instrument, and vice versa. Note, however, that Standard MIDI Files ensure the compatibility of data such as NOTE data (keyboard performance data), VELOCITY (how hard the keyboard is played), PROGRAM NUMBER data (voice number data), etc. Because it does not guarantee 100% faithful reproduction of recorded music which is replete with such data, it may be necessary for you to adjust the settings to your satisfaction.

- Only files with the “.MID” extension can be loaded.
- Standard MIDI File FORMAT 1 can be loaded, but not saved.
- This instrument’s **SEQUENCER** data can be saved to a disk in Standard MIDI File (FORMAT 0) and can be used by other equipment.

Playback of commercial song disks

DIRECT PLAY lets you enjoy playing commercially sold song disks directly from a disk. It’s fast because you don’t have to load the disk data into your instrument’s memory.

- DIRECT PLAY is possible from the following disks:

Standard MIDI File
Standard MIDI File with Lyrics
DISK ORCHESTRA COLLECTION™ (DOC)
PianoDisc™

* All product and company names are trademarks or registered trademarks of their respective owners.

* DISK ORCHESTRA COLLECTION is a trademark of the YAMAHA Corporation.

■ SMF with LYRICS

SMF with LYRICS is a format in which character information that is included with the MIDI data, such as karaoke lyrics, can be displayed. This instrument supports this format, making it possible to view the lyrics on the display while a performance is played back.

**SMF
LYRICS**

■ GENERAL MIDI LEVEL 2 (GM2)

This instrument complies with GENERAL MIDI (GM) LEVEL 2 standards. GM LEVEL 2 is a uniform world standard for MIDI sound generators that improves on existing GM standards, in order to realize an enhanced performance expression. Sound generators of this class can reproduce virtually the identical conditions that were in effect at the time of recording.

Equipment which conforms to GENERAL MIDI LEVEL 2 standards is indicated by the following logo.

**GENERAL
MIDI2**

- This instrument also conforms to GENERAL MIDI playback.

**GENERAL
MIDI**

Outline of the procedure

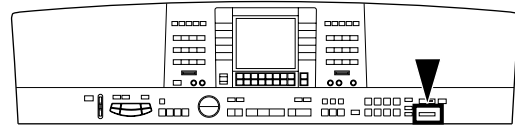

1. Insert the disk into the Disk Drive slot. Push it all the way in until you hear a click.
 - On this instrument, if the normal display is active, it automatically changes to the DISK MENU display when a disk is inserted into the Disk Drive (initialized settings). The PREFERENCES menu is used to specify which display is shown when a disk is inserted.
2. Select a menu on the DISK MENU display.
 - If the DISK MENU display does not appear, turn on the **DISK** button.
3. Follow the procedure for the function (see below).
 - When function is being set, if the **TEMPO/PROGRAM** indicator is lit, the **TEMPO/PROGRAM** is available for setting the current function.
4. When you have finished setting the functions, turn off the **DISK** button.

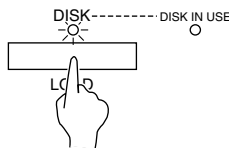

■ DISK IN USE

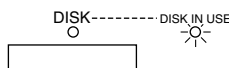

This indicator lights when data is being loaded or saved.

- To prevent data loss, do not eject the disk or turn off the power while this indicator is lit.

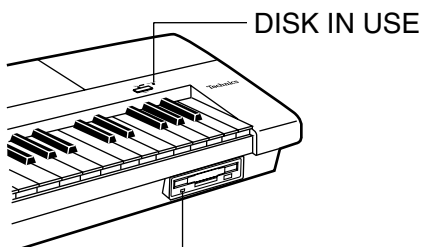

This indicator is lit continuously as long as the power is on.

■ About the menu



LOAD (page 120)

Load data from a disk into this instrument's memory.

SAVE (page 125)

Save data from this instrument's memory to a disk.

DIRECT PLAY (page 122)

Direct playback of SMF etc. commercial song disks and medley playback.

SONG MEDLEY (page 124)

Medley playback of songs in the disk (Technics format).

DISK TOOLS (page 128)

Disk management procedures, such as disk format.

PREFERENCES (page 130)

Used to specify which screen is to be jumped to as well as the preferred file when a disk is inserted.

Loading data

Recall (load) the data from the disk to this instrument's memories.

- Note that the load procedure causes any data which is currently stored in the relevant memories to be erased.

LOAD

Load data that saved to a disk into this instrument's memory.

1. Insert the disk with the stored data into the Disk Drive. Push it all the way in until you hear a click.

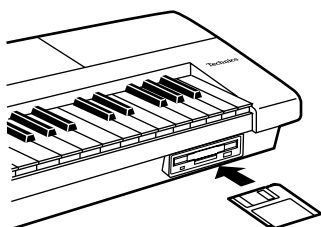

2. On the DISK MENU display, select LOAD.
 - The display looks similar to the following.

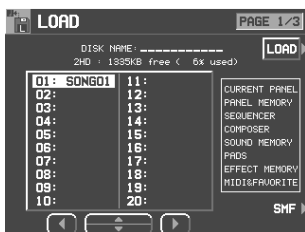

- If there are only SMF files on the disk, the display automatically changes to the SMF LOAD display.
3. Use the buttons below the display to select the song (Technics file) you wish to load.
 - If there are SMF files on the disk and you wish to load an SMF file, press the SMF button. (Refer to next page.)
 4. Press the LOAD button.
 - The LOAD operation begins.
 - When the operation has been successfully completed, "COMPLETED!" is shown on the display.
 - If song data was loaded, you can press the **START/STOP** button to begin playback when the SEQUENCER PLAY display is active.

- You can load the type of data for which only one song can be recorded in the **SEQUENCER**. (This type is available for disks used with older Technics models.) Note, however, that in this case, the song is loaded into SONG 1, but the data in SONG memories 2 to 10 are erased.
- You can also access the LOAD display by pressing the **DISK** button for a few seconds.

LOAD OPTION

Specify the kind of data you wish to load from the disk to your instrument.

1. Use the **PAGE** buttons to access the PAGE 2/3 LOAD OPTION display.
 - The display looks similar to the following.



2. Use the buttons below the display to specify the types of data you wish to load (YES/NO).
 - - - - - indicates that this type of data has not been saved.
 - This setting is canceled when you quit the LOAD display or when another file is selected.
3. Press the LOAD button.
 - The LOAD operation begins.

■ SINGLE LOAD

You can specify which data to load from a disk into a specific **PANEL MEMORY**, **COMPOSER (MEMORY)**, **SOUND MEMORY**, **EFFECT MEMORY** or **SEQUENCER** (when SONG SAVE was executed) memory.

1. Use the **PAGE** buttons to access the PAGE 3/3 SINGLE LOAD display.
- The display looks similar to the following.

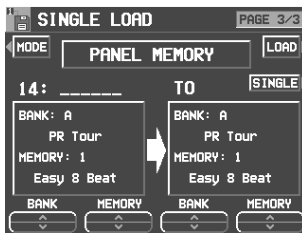

2. Use the **MODE** button to select the data you wish to load.
3. Use the **BANK/SINGLE** button to select the load increment. (except for **SEQUENCER**)
BANK:
 Load one bank at a time.
SINGLE:
 Load the smallest data increment.
4. Follow the appropriate procedure to load the specified data.
 - Specify the data source for SONG (left side), and the data destination (this instrument's memory location) for TO.

■ SMF LOAD

Load data which was saved in the "Standard MIDI File" (SMF) format.

1. On the **LOAD (PAGE 1/3)** display, press the **SMF** button.
- The display looks similar to the following.



- For disks which contain SMF files only, this display appears automatically when **LOAD** is selected on the **DISK MENU** display.

2. Use the buttons below the display to select the filename you wish to load.
 - If the number of files is 10 or more, you can use the **PREV** and **NEXT** buttons to go back or advance 10 files at a time.
 - If you press the **TECH** button, the display changes to the **LOAD** display for Technics format.
 - You can use the **INFORMATION** button to switch the displayed data.

DISK: Disk name
SONG: Song name

3. Use the **TO SONG** button to select the number to load to (this instrument's **SEQUENCER** song number).
 - Songs to load are specified one at a time.
 - The song name to load to is shown below the **TO SONG** button.
4. Use the **LOAD AS** button to specify the load method.
 Select from the following.
GM/GM2 → GM2:
 Activate the GM2 initialized settings, and load GM/GM2 data.
NX → NX:
 Active the NX SOUND settings, and load NX data.
GM/GM2 → NX:
 Activate the NX SOUND initialized settings, and load GM/GM2 data.
PREV. TEC → NX:
 Activate the NX SOUND initialized settings, and load SMF data that was saved in the **TECHNICS** mode on a previous model. (The volume balance and octave settings may differ from the saved settings.)

- If you select the setting which is different from that in which the song was stored, the sounds, octaves, and arrangement of percussion instrument sounds, etc. will be different.

5. Press the **LOAD** button.
 - The **LOAD** operation begins.
 - When the operation has been successfully completed, "COMPLETED!" is shown on the display.
 - If you press the **START/STOP** button, playback of the loaded data begins.
 - During the **LOAD** operation, data that cannot be processed by this instrument is ignored.

■ COMPOSER LOAD

Load **COMPOSER** data only from a disk.

1. In the **RHYTHM GROUP** section, press and hold the **LOAD (MEMORY)** button for a few seconds.

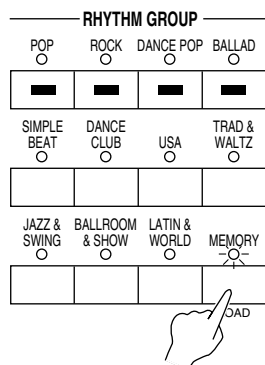

- The display looks similar to the following.



2. Select the name of the file you wish to load.
 3. Press the **LOAD** button.
- Data is loaded to this instrument's **COMPOSER** memory (**MEMORY**).

Direct Play

You can enjoy immediate playback of “Standard MIDI File” (SMF), “Disk Orchestra Collection” (DOC) and “PianoDisc” disks—all without loading the song data.

1. Insert the disk with the stored data into the Disk Drive.
 2. On the **DISK MENU** display, select **DIRECT PLAY**.
- The display looks similar to the following.

<Example: SMF>



3. Use the buttons below the display to select the song you wish to have played.
- If the number of files is 10 or more, you can use the **PREV** and **NEXT** buttons to go back or advance 10 files at a time.
 - For SMF files, use the **PLAY AS** button to specify a sound arrangement mode.

GM2: GENERAL MIDI LEVEL 2

NX: NX SOUND

PREV. TEC: Data from Technics instruments not having NX SOUND capability.

- For SMF files, you can use the **INFO** button to switch the displayed data.
DISK: Disk name
SONG: Song name
- For SMF files, use the **MIDI OUT** button to specify whether or not MIDI data is output during playback (ON/OFF). (This cannot be changed during playback.)

4. Press the **START** button.
- The selected song is played back.

■ Adjusting the playback tempo

Even with a song having recorded tempo data, you can use **TEMPO/PROGRAM** or **TAP TEMPO** to adjust the tempo to your liking.

- When the tempo is changed, all the tempo data of that song is automatically changed by the same ratio. Accordingly, even in song data in which tempo change data is stored, a single adjustment of the tempo produces a natural-sounding playback.

■ The display during playback

<Example: SMF>

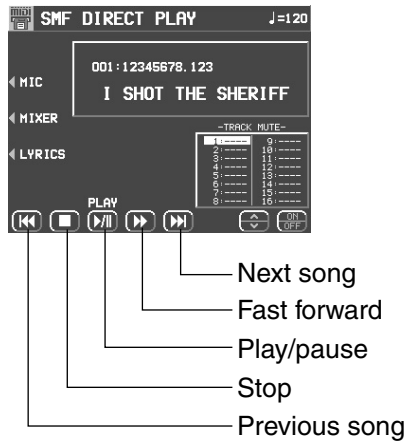

- During playback, the buttons below the display are used for player functions such as fast forward, pause, etc.
- During playback, if you press the MIXER button you can change the settings for each part.
- If you press the MIC button during playback, the display changes to the MIC REVERB & EFFECT setting display.
- For SMF disks:
For “SMF with LYRICS” disks, by pressing the LYRICS button, the lyrics are shown on the display.
For a “minus one” performance, use the TRACK MUTE ^, v buttons to select the channel you wish to mute. Use the ON/OFF buttons and set the track you want to MUTE to ON. Following this, you can play a keyboard performance on the channel which was last set to MUTE.
- For DOC disks:
You can use the PART 1, PART 2 and ORCH (other accompaniment parts) buttons to set the respective parts to ON or OFF.
- For PIANO DISC playback:
You can use the PART 1 and ORCH (other accompaniment parts) buttons to set the respective parts to ON or OFF.

■ MEDLEY PLAY

With DIRECT PLAY, songs saved on a disk can be played back continuously in a medley.

1. On the DIRECT PLAY display, set the MEDLEY settings.
 - If ALL is pressed, all the files are selected, and the songs are played back in order in a medley. If ALL is pressed again, the files are deselected.
 - You can use the buttons below the display to select a song to add to the song list, then press the ADD button to add it to the list. Repeat these steps to create your own list of songs to have played back. A M01, M02 etc. next to the file name indicates its order in the list.
 - If the number of files is 10 or more, you can use the PREV and NEXT buttons to go back or advance 10 files at a time.
 - You can delete a marked file from the medley song list by selecting it and pressing the ADD button.
 - Use the LOOP button to specify ON or OFF for repeat playback of the medley.
2. Press the START button.
 - Medley playback begins.
 - During medley playback, you can use the SKIP button to skip to the next song.

Song Medley

Songs saved from the **SEQUENCER** to a disk (disk data) in the TECHNICS FORMAT can be played back in a medley.

1. On the DISK MENU display, select SONG MEDLEY from the display.
 - The display looks similar to the following.



2. Select the order of files in the medley.
 - If ALL is pressed, all the files are selected, and the songs are played back in numerical in a medley.
 - You can select a file and song, then press the ADD button to add it to the song list. Repeat these steps to create your own list of songs to have played back. A M01, M02 etc. next to the file name indicates its order in the list.
 - You can delete a marked file from the medley song list by selecting it and pressing the ADD button.
 - Use the LOOP button to specify ON or OFF for repeat playback of the medley.
 - You can use the MODE button to select the medley mode.
 - 10 SNGS:
Songs 1 to 10 from each SONG are played in a medley.
 - 1 SONG:
Only song 1 from each SONG is played back in a medley.
3. Press the START button.
 - Medley playback begins.
 - During the performance, the display changes to the playback display.
 - During a medley performance, if you press the MIXER button you can change the settings for each part.
 - During a medley performance, you can use the SKIP button to skip to the next song.
 - If the disk contains SMF or other files, but no TECHNICS FORMAT file, the display changes to the DIRECT PLAY display.

Saving data

The recorded data and panel settings of this instrument can be saved on a disk.

Disks

You can use 3.5 inch 2DD (720KB) or 2HD (1.44MB) disks.

- How to distinguish the two disk types:

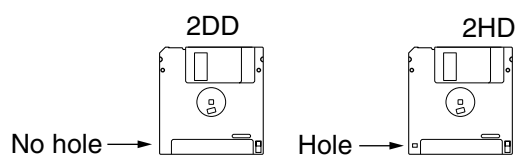

- Although 2HD disks can hold more data and are convenient for quick loading and saving, some models may be able to read only 2DD disks. Therefore, you may not be able to use your 2HD disk data with other musical instrument models.

- When saving data to the disk, the write-protect tab must be closed.

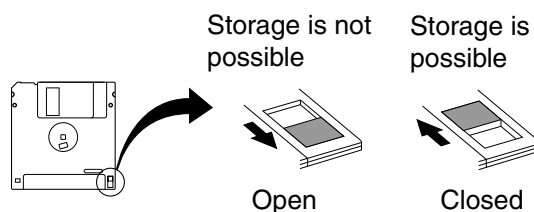

SAVE

1. Insert a formatted disk into the Disk Drive slot.
Push it all the way in until you hear a click.
 - A disk which is used with this instrument for the first time must first be formatted.
2. On the DISK MENU display, select SAVE.
 - The display looks similar to the following.



3. Select the type of data save you want.

TECHNICS FORMAT:

Save this instrument's data in the Technics File format.

SMF FORMAT 0:

Save the **SEQUENCER** data in the "Standard MIDI File" format (FORMAT 0).

■ TECHNICS FORMAT



- Use the buttons below the display to specify the file number you wish to save to.
 - The types of data that can be saved are shown in a frame on the right side of the display. If you press the SAVE button, all the indicated data is saved. Ordinarily PERFORMANCE data is selected, but you can use the SAVE OPTION to select specific data to save.
- If you wish to assign a name to the file, press the NAME button.
 - The display looks similar to the following.



- Use the buttons below the display to assign a name.
 - Set the character input position with the POSITION buttons, select the characters with the alphanumeric buttons and repeat name assignment.
 - Press the INS button to enter a space at the cursor position.
 - Press the DEL button to erase the character at the cursor position.
 - Press the CLR button to erase the entire name.
 - Press the →← button to center the name.
- Press the OK button.
 - The display returns to the SAVE display.
- Press the SAVE button.
 - The SAVE operation begins.
 - If you attempt to save data to a file number in which data is currently saved, the display changes to the confirmation display. Press the YES button to continue the SAVE procedure, or press the NO button if you wish to cancel it.

<SAVE OPTION>

Specify the kind of data you wish to save to the disk. To maximize effective use of disk memory or to minimize the save time, select only the type of data you wish to save.

- Use the **PAGE** buttons to access the 2/3 SAVE OPTION display.
 - The display looks similar to the following.



- Use the buttons below the display to specify the types of data you wish to save (YES/NO).
 - For PANEL MEMORY, select from NO/1 BANK/ALL. Selecting 1 BANK will save only bank A.
 - Press the PERFORM button to select all the performance data, or press the BACKUP button to select all the back up data at once.
 - If the ALL OFF button is pressed, all the settings change to NO.
- Press the SAVE button.
 - The SAVE operation begins.

<SEQUENCER SONG SAVE>

You can specify a single song in the **SEQUENCER** to save to the disk.

1. Use the **PAGE** buttons to access the 3/3 **SEQUENCER SONG SAVE** display.
- The display looks similar to the following.

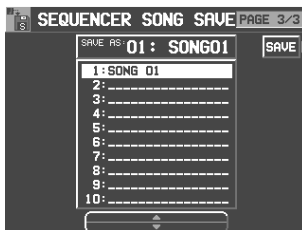

2. Use the buttons below the display to select the song number you wish to save.
3. Press the **SAVE** button.
- The **SAVE** operation begins.

■ **SMF FORMAT 0**

This instrument's **SEQUENCER** data can be saved in the "Standard MIDI File" format (**FORMAT 0**) for use on other instruments.

- What you can save in the SMF format (**FORMAT 0**) is ordinary performance data, such as note data. Data such as chord and rhythm data, **COMPOSER** data, etc. is not saved. If you wish to also save this special Technics data, save the data in the Technics File format.
- If you use the **APC TO SMF CONVERT** function of the **SEQUENCER**, you can convert the patterns of the automatic accompaniment, etc. to SMF data. (Refer to page 100.)



1. To overwrite a file, use the ▲ and ▼ buttons and then select a song name.
- If the number of files is 10 or more, you can use the **PREV** and **NEXT** buttons to go back or advance 10 files at a time.
2. If you wish to assign a name to the file, press the **NAME** button.
3. Use the buttons below the display to assign a name.
4. Press the **OK** button.
- The display returns to the **SAVE** display.
5. Use the **FROM SONG** buttons to select the **SEQUENCER** song number you wish to save.
- The song name to save from is shown below the **FROM SONG** button.
6. Use the **PANEL HEADER** buttons to specify **ON** or **OFF**.
 - ON:**
The sound and volume settings for each part are saved as data at the beginning of the file.
 - OFF:**
This data is not saved.

(Continued on the next page)

7. Use the 1 MEASURE SPACE buttons to select ON or OFF.

ON:

A one-measure space is added to the beginning of the file.

OFF:

No space is added.

- When there is various data other than performance data stored at the beginning of a file, the start of playback may be delayed. This can be avoided by set the 1 MEASURE SPACE to ON to inserting a before the beginning of the performance.
- When set to ON, a space is added each time a file is saved. Therefore, if you have already saved a file once with the 1 MEASURE SPACE set to ON, please set it to OFF each time the file is subsequently saved.

8. Use the SAVE AS button to select the sound generator mode (GM/GM2/NX).

9. Press the SAVE button.

- The SAVE operation begins.
- When the operation has been successfully completed, "COMPLETED!" is shown on the display.
- If you attempt to save data to a file name in which data is currently saved, the display changes to the confirmation display. Press the YES button to continue the SAVE procedure, or press the NO button if you wish to cancel it.

Disk management

Various disk management procedures, such as file delete, file copy, and disk format, are available from the DISK TOOLS menu.

DISK TOOLS

1. Insert the disk into the Disk Drive slot.
2. On the DISK MENU display, select DISK TOOLS from the display.
 - The display looks similar to the following.



3. Select a function and follow the procedure to execute it.
 - Use the buttons below the display to select a file.
 - You can press the SMF/TECH button to change to the display for procedures related to SMF/TECH files.
 - Use the buttons to the left and right of the display to access the corresponding setting display.

- **RENAME:**
Assign a name to a file.
- **DEL:**
Delete a file.
- **COPY (TECH):**
Copy a file.
- **MOVE (TECH):**
Replace a file.
- **INFO (DISK/SONG) (SMF files only):**
Select whether to display the disk data or the song names.
- **FORMAT**
Disks which are used for the first time with this instrument have to be formatted through the following procedure. When an unformatted disk is inserted into the Disk Drive slot and you attempt to execute the save or load procedure, the DISK FORMAT display appears. Follow the instructions shown to format the disk.

- Note that this procedure clears any data which is currently stored on the disk.
1. Select the type of format (2DD or 2HD).
- Be sure to select the type which is the same as your disk type.
 - If the type is automatically detected, the display changes directly to the following display, without showing the type select display.
 - The display looks similar to the following.

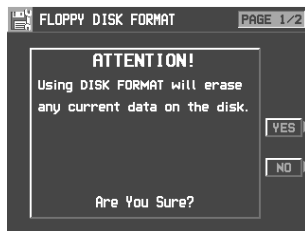

- If you wish to select the type again, use the **PAGE** button to access the PAGE 2/2 display.
2. Press the YES button to format the disk, or press the NO button to cancel the format.
- When the YES button is pressed, disk format begins. After about 1–2 minutes, formatting is completed and DISK NAMING display is shown.
3. Use the buttons below the display to assign a name.
- Set the character input position with the POSITION buttons, select the characters with the alphanumeric buttons and repeat name assignment.
 - Switch from upper to lower case letters with the ABC, abc button.
 - Press the INS button to enter a space at the cursor position.
 - Press the DEL button to erase the character at the cursor position.
 - Press the CLR button to erase the entire name.
 - Press the →← button to center the name.
4. Press the OK button.

Set the automatic display when a disk is inserted

When a disk is inserted in the Disk Drive, the display automatically changes to a disk-procedure display. Follow this procedure to customize the automatic display.

PREFERENCES

1. On the DISK MENU display, select PREFERENCES.
 - The display looks similar to the following.

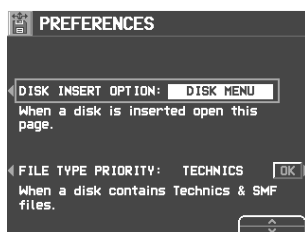

2. Use the buttons to the left of the display to select the item, and the \wedge and \vee buttons to change the setting.

DISK INSERT OPTION:

The display automatically changes to a disk-procedure display when a disk is inserted in the Disk Drive (OFF, DISK MENU, LOAD, DIRECT PLAY, SONG MEDLEY).

- During playback, recording or changing the settings, the displays unrelated to the settings made here do not change.

FILE TYPE PRIORITY:

Specify the desired priority ranking of displayed files when several types of files are recorded on one disk (TECHNICS/SMF).

3. Press the OK button.

Part VII SD Card (KN2600)

Outline of the SD card

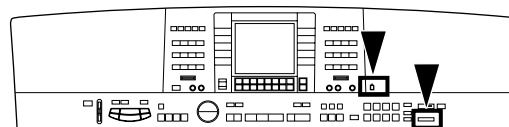

The data generated by this instrument can be stored and managed on an SD card in SMF or TECHNICS format.

Structure of the SD card format

SD-AUDIO	Music (audio) data
SD-SOUND	SMF data
PRIVATE	local data of the instrument

Management inner memory data

The instrument inner memory data can be managed using the high space capacity of the SD card. The data which can be saved and loaded is same as the **DISK DRIVE** (KN2400). (See page 119.)

Play an SD card

Besides saving, you can enjoy playback of audio or SMF data saved on the SD card. (Refer to pages 136, 137.)

SD-AUDIO

AUDIO data stored on an SD card using SD format software.

SD-SOUND

SMF data (SD-SOUND format) saved on the SD card

Outline of the procedure

1. Open the lid of the SD slot.

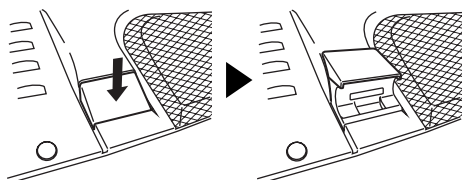

- Open it completely.

2. Insert the SD card.

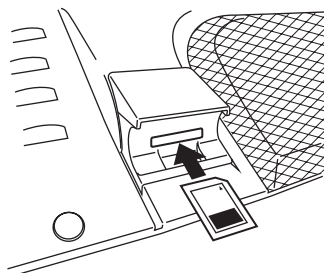

- Push the card until it locks as shown in the figure.

3. Close the lid.

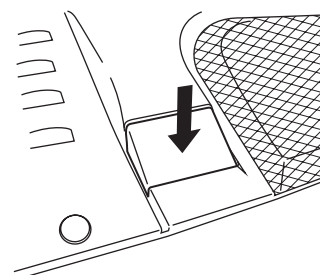

- No operation is possible when the lid is open.

4. Press the **SD** button to turn it on.

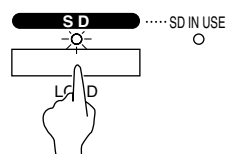

5. Select a menu on the SD MENU display.

6. Follow the procedure for the function (see below).

- When function is being set, if the **TEMPO/PROGRAM** indicator is lit, the **TEMPO/PROGRAM** is available for setting the current function.

7. When you have finished setting the functions, press the **SD** button to turn it off.

■ **SD IN USE**

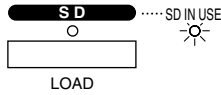

- This indicator lights when accessing to the SD card.

To prevent data loss, do not eject the card or turn off the power while this indicator is lit.

■ **Removing the SD card**

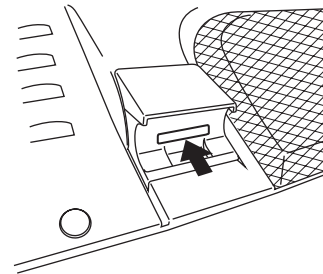

When the SD IN USE indicator is not lit, while opening the lid, push the center of the card to unlock it.

Attention

Note that no sound is produced when performing SD card operations, such as LOAD or SAVE. Also, the instrument produces no sound when one of following displays appears (The keyboard will emit sound.):

- LOAD (TECH) PAGE 3
- SD SONG MEDLEY
- COPY FROM DISK (SD TOOLS)
- SD-SOUND EXPORT/IMPORT (SD-TOOLS)

■ **SD MENU**

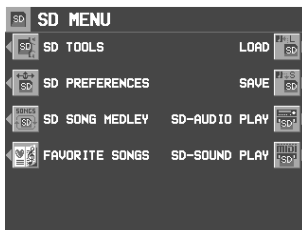

LOAD (page 130)
Load data into this instrument from the card.

SAVE (page 140)
Save data on the card from this instrument.

FAVORITE SONGS (page 143)
Arrange the order of your favorite songs stored on the card.

SD-AUDIO PLAY (page 136)
Play back audio data stored on the card.

SD-SOUND PLAY (page 137)
Play directory SD-SOUND (SMF) data on the card.

SD SONG MEDLEY (page 139)
Play back music data on the card (TECHNICS format) successively in a medley.

SD TOOLS (page 144)
Card management procedures, such as card format.

SD PREFERENCES (page 145)
Set the priority for displaying while saving or loading data.

Loading data

Load the data from the SD card to this instrument's memories.

- Note that the load procedure causes any data which is currently stored in the relevant memories to be erased.

SD LOAD

Load data that saved to a card into this instrument's memory.

1. Insert the SD card with the stored data into the SD slot. (See page 131.)
 - Close the lid securely.
2. Press the **SD** button to turn it on.

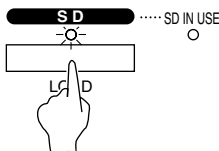

3. On the SD MENU display, select **LOAD**.
 - The display looks similar to the following.



- If there are only SMF files on the card, the display automatically changes to the SD-SOUND (SMF) LOAD display.

■ FOLDER



1. Use the buttons below the display to select the **SONG** you wish to load.
 - Select the folder name first, and then select the **SONG** name.
 - Press the **PREV** button for the previous page and the **NEXT** button for the next page.

4. Use the buttons to the right of the display to select the type of loading.

FOLDER:

Select files to load from a list of all folders and of saved songs in each folder.

ALPHABET (See page 134.)

Select files to load from an alphabetical list of all songs.

NUMBER (See page 134.)

Select files to load specifying folder and song numbers.

- The priority that sets which display is shown first can be set at the SD PREFERENCES display. (Refer to page 145.)

2. Press the **LOAD** button.

- The **LOAD** operation begins.
- When the operation has been successfully completed, "COMPLETED!" is shown on the display.
- If song data was loaded, you can press the **START/STOP** button to begin playback when the **SEQUENCER PLAY** display is active.
- You can load the type of data for which only one song can be recorded in the **SEQUENCER**. (This type is available for cards used with older Technics models.) Note, however, that in this case, the song is loaded into **SONG 1**, but the data in **SONG** memories 2 to 10 are erased.
- You can also access the **LOAD** display by pressing the **SD** button for a few seconds.

■ ALPHABET

Load the file from an alphabetical list of all songs saved in TECHNICS format on the SD card.

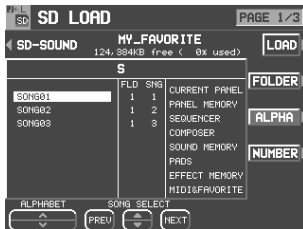

1. Use the ^ and v buttons to change the alphabetical letter or the display page.
2. Use the ▲ and ▼ buttons to specify the song to be loaded.
 - Press the PREV button for the previous page and the NEXT button for the next page.
3. Press the LOAD button.

■ NUMBER

From all songs saved in the TECHNICS FORMAT on the SD card, select a song by specifying the song number.

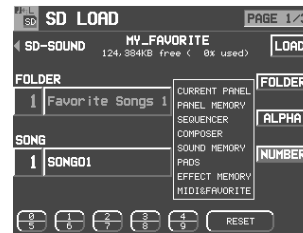

1. Use the buttons below the display to specify the song number.
 - Specify the FOLDER (01–99) first, and then select the SONG (01–20).
 - A number should be specified as a 2-digits number. (Press 0, 1 for the number 1.)
2. Press the LOAD button.

<LOAD OPTION>

Specify the kind of data you wish to load from the SD card to your instrument.

1. Use the PAGE buttons to access the PAGE 2/3 display.
 - The display looks similar to the following.

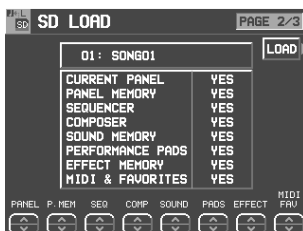

2. Use the buttons below the display to specify the types of data you wish to load (YES/NO).
 - - - - - - indicates that this type of data has not been saved.
 - This setting is canceled when you quit the LOAD display or when another file is selected.
3. Press the LOAD button.
 - The LOAD operation begins.

<SINGLE LOAD>

You can specify which data to load from an SD card into a specific PANEL MEMORY, COMPOSER (MEMORY), SOUND MEMORY, EFFECT MEMORY or SEQUENCER (when SONG SAVE was executed) memory.

1. Use the PAGE buttons to access the PAGE 3/3 display.
 - The display looks similar to the following.

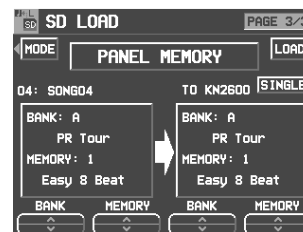

2. Use the MODE button to select the data you wish to load.
3. Use the BANK/SINGLE button to select the load increment. (except for SEQUENCER)
 - BANK: Load one bank at a time.
 - SINGLE: Load the smallest data increment.
4. Follow the appropriate procedure to load the specified data.
 - Specify the data source for SONG (left side), and the data destination (this instrument's memory location) for TO.

COMPOSER LOAD

Load **COMPOSER** data only from a card.

1. In the **RHYTHM GROUP** section, press and hold the **LOAD (MEMORY)** button for a few seconds.

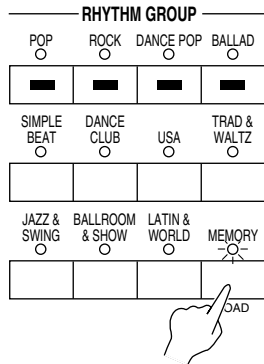

- The display looks similar to the following.



2. Use the buttons below the display to select the **SONG** you wish to load.
 - Select the folder name first, and then select the **SONG** name.
 - Press the **PREV** button for the previous page and the **NEXT** button for the next page.
3. Press the **LOAD** button.
 - Data is loaded to this instrument's **COMPOSER** memory (**MEMORY**).

SD-SOUND LOAD (SMF)

Load **SD-SOUND (SMF)** data from the SD card.

1. On the **LOAD (PAGE 1/3)** display, press the **SD-SOUND** button.
 - The display looks similar to the following.



- For cards which contain **SD-SOUND** data only, this display appears automatically when **LOAD** is selected on the **SD MENU** display.

2. Use the buttons below the display to select the **SONG** name you wish to load.
 - Use the **PLAYLIST** button to specify the **PLAYLIST** (see page 138), the **SONG SELECT** button to specify the **SONG**.
 - If you press the **PLAYLIST EDIT** button, the display changes to the **PLAYLIST EDIT** display. (See page 138.) If you press the **TECH** button, the display changes to the **LOAD** display for the **TECHNICS SONG**.
3. Use the **TO SONG** button to select the number to load to (this instrument's **SEQUENCER** song number).
 - Songs to load are specified one at a time.
 - The **SEQUENCER** song name to load to is shown below the **TO SONG** button.
4. Use the **LOAD AS** button to specify the load method.
 - Select from the following.
 - GM/GM2 → GM2:**
Activate the **GM2** initialized settings, and load **GM/GM2** data.
 - NX → NX:**
Active the **NX SOUND** settings, and load **NX** data.
 - GM/GM2 → NX:**
Activate the **NX SOUND** initialized settings, and load **GM/GM2** data.
 - PREV. TEC → NX:**
Activate the **NX SOUND** initialized settings, and load **SMF** data that was saved in the **TECHNICS** mode on a previous model. (The volume balance and octave settings may differ from the saved settings.)
5. Press the **LOAD** button.
 - If you select the setting which is different from that in which the song was stored, the sounds, octaves, and arrangement of percussion instrument sounds, etc. will be different.
 - The **LOAD** operation begins.
 - When the operation has been successfully completed, "**COMPLETED!**" is shown on the display.
 - If you press the **START/STOP** button, playback of the loaded data begins.
 - During the **LOAD** operation, data that cannot be processed by this instrument is ignored.

SD-Audio Play

Play back audio data on the SD card saved by a PC, etc.

1. Insert the SD card with the stored data to be played into the SD slot. (See page 131.)

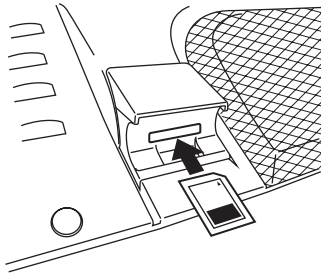

- Close the lid securely after inserting the card.

2. Press the **SD** button to turn it on.

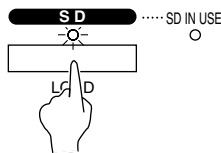

3. On the SD MENU display, select SD-AUDIO PLAY.

- The display looks similar to the following.



- Using the PLAY MODE button, you can select the type of playback.

NORMAL:

For playing back the songs in sequential order.

ALL REPEAT:

For playing back all the songs repetitively.

1 SONG REPEAT:

For playing back a song repetitively.

- You can select PLAY LIST using the PLAYLIST SELECT button as necessary.

4. Playback the data by pressing the button below the display.

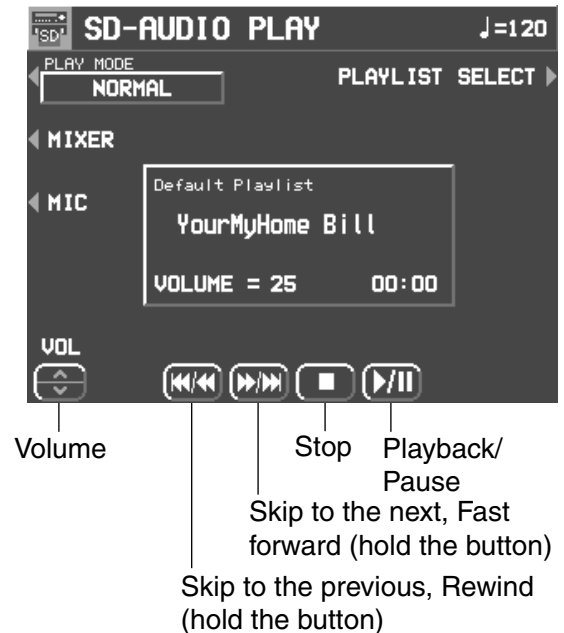

- Adjust the volume for playback using the VOL \wedge and \vee buttons.

SD-Sound Play

Play back SMF data saved on the SD card (SD-SOUND).

- Lyrics of the SMF with LYRICS files can be also displayed.

1. Insert the SD card with the stored data to be played into the SD slot. (See page 131.)
 - Close the lid securely after inserting the card.
2. Press the **SD** button to turn it on.
3. On the SD MENU display, select SD-SOUND PLAY.
 - The display looks similar to the following.



4. Press the buttons above the display to play back the data.
 - For the function of each button, see page 136.
 - Press the **PLAYLIST SELECT** button to select a **PLAYLIST**.



- Using the **PLAY MODE** button, you can select the type of playback.

NORMAL:

For playing back the songs in sequential order.

ALL REPEAT:

For playing back all the songs repetitively.

1 SONG:

For playing back only one song.

1 SONG REPEAT:

For playing back a single song repetitively.

- Press the **LYRICS** button to show the lyrics.
- The **PLAY AS** button functions like as the **LOAD AS** button. (Refer to page 135.)

- To have a minus-one play, use the \wedge and \vee buttons to select a part or parts and set ON/OFF to the part. The part being muted last is assigned to the keyboard, so that you can play the part with the keyboard. You can also assign the part to play with the keyboard using the **CONDUCTOR**.
- Adjust the volume for playback using **VOL**.

■ Adjusting the playback tempo

Even with a song having recorded tempo data, you can use **TEMPO/PROGRAM** or **TAP TEMPO** to adjust the tempo to your liking.

- When the tempo is changed, all the tempo data of that song is automatically changed by the same ratio. Accordingly, even in song data in which tempo change data is stored, a single adjustment of the tempo produces a natural-sounding playback.

Playlist

The instrument handles the SD-AUDIO/SD-SOUND files in PLAYLIST units. The explanation of the PLAYLIST is as follows.

PLAYLIST type

There are two types of PLAYLIST.

<DEFAULT PLAYLIST: (Total list)>

A collection of all data saved in an SD card. If you delete a song from the default PLAYLIST, the song data itself will be deleted on the card.

<PLAYLIST>

When the music data is transferred to the SD card from a PC, a play list is created automatically on the card. You can freely name this type of play lists. Also, you can create a new PLAYLIST which contains your favorite songs selected from the DEFAULT PLAYLIST or other PLAYLISTs.

MEMO

You can create PLAYLISTs on an SD card within the following limits.

- Maximum number of PLAYLISTs: 99
- Maximum number of songs: 999
- Maximum number of songs in a PLAYLIST: 99

PLAYLIST EDIT

You can edit a PLAYLIST for SD-SOUND freely except for the DEFAULT PLAYLIST.

- You can edit the DEFAULT PLAYLIST on the SD TOOLS display. (Refer to page 144.)

1. On the PLAYLIST SELECT display, press the EDIT button.
- The PLAYLIST SELECT display appears when you press the PLAYLIST SELECT button on the SD-SOUND display. (Refer to page 137.)
- The display looks similar to the following.



2. Edit the PLAYLIST.

- Select the songs to copy from in the left column of the display, assign to them desired song numbers for the TARGET PLAYLIST and press the SET button. This creates a new PLAYLIST of the selected songs with assigned song numbers.
- Use the MOVE button to change the order of the songs.

- Press the DEL button to delete the songs which are currently selected on the “Target Playlist.”
- Press the PLAYLIST NEW button to select a new, blank PLAYLIST as a TARGET PLAYLIST.
- Press the PLAYLIST DEL button to delete PLAYLIST which is currently selected as TARGET PLAYLIST.
- Press the TARGET PLAYLIST NAMING button to name the PLAYLIST which is being currently edited.

3. Press the OK button.

SD Song Medley

Songs saved from the SEQUENCER to an SD card in the TECHNICS FORMAT can be played back in a melody.

1. On the SD MENU display, select SD SONG MEDLEY.
 - The display looks similar to the following.

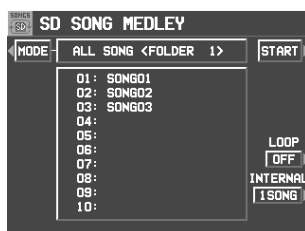

2. Press the MODE button to select the type of medley list.

ALL SONG:

A list of all songs in all folders

FOLDER:

A list of all songs in a selected folder.

- Press the FOLDER SELECT button to select the folder to play.

USER LIST 1-3:

Lists which can be set freely. (See below.)

- Use the LOOP button to specify ON or OFF for repeat playback of the medley.
- You can use the INTERNAL button to select the medley mode.

10 SNGS:

Songs 1 to 10 from each SONG are played in a medley.

1 SONG:

Only song 1 from each SONG is played back in a medley.

3. Press the START button.

- Medley playback begins.
- During the performance, the display changes to the playback display.
- During a medley performance, if you press the MIXER button you can change the settings for each part.
- During a medley performance, you can use the SKIP button to skip to the next song.

■ Making a USER LIST

You can create up to three USER LISTS.

1. Select one of three USER LISTS (1 to 3) using the MODE button and then press the USER LIST EDIT button.
2. Specify the order of songs to play in medley.
 - Select FOLDER and SONG, specify the sequence of songs in the LIST column to the right, press the SET button, and repeat those steps.
 - Press the DEL button to delete the songs selected in the LIST column.
 - The USER LIST settings are memorised independently on each card.

Saving Data

The internal data of this instrument can be saved on the SD card.

SAVE

1. Insert an SD card for saving into the SD slot.
(See page 131.)
2. Press **SD** button to turn it on.
3. On the SD MENU display, select **SAVE**.
 - The display looks similar to the following.



4. Select the type of data save you want.

TECHNICS FORMAT:

Save this instrument's data in the Technics File format.

SD-SOUND (SMF) FORMAT:

Save the SEQUENCER data as SD-SOUND (SMF) data.

■ TECHNICS FORMAT



1. Use the buttons below the display to specify the song number you wish to save to.
 - Select the **FOLDER** number first, and select the **SONG** number.
 - The types of data that can be saved are shown in a frame on the right side of the display. If you press the **SAVE** button, all the indicated data is saved. Ordinarily **PERFORMANCE** data is selected, but you can use the **SAVE OPTION** to select specific data to save.
2. If you wish to assign a name to the file, press the **SONG NAMING** button.
 - The display looks similar to the following.



3. Use the buttons below the display to assign a name.
 - Set the character input position with the **POSITION** buttons, select the characters with the alphanumeric buttons and repeat name assignment.
 - Switch from upper to lower case letters with the **ABC, abc** button.
 - Press the **INS** button to enter a space at the cursor position.
 - Press the **DEL** button to erase the character at the cursor position.
 - Press the **CLR** button to erase the entire name.
 - Press the **→←** button to center the name.
4. Press the **OK** button.
 - The display returns to the **SAVE** display.
 - If you wish to assign a name to the folder, press the **FOLDER RENAME** button and follow the operation described above.

5. Press the **SAVE** button.
 - The **SAVE** operation begins.
 - If you attempt to save data to a **SONG** number in which data is currently saved, the display changes to the confirmation display. Press the **YES** button to continue the **SAVE** procedure, or press the **NO** button if you wish to cancel it.

<SAVE OPTION>

Specify the kind of data you wish to save to the SD card. To maximize effective use of SD card memory or to minimize the save time, select only the type of data you wish to save.

1. Use the **PAGE** buttons to access the 2/3 display.
- The display looks similar to the following.



2. Use the buttons below the display to specify the types of data you wish to save (YES/NO).
 - For PANEL MEMORY, select from NO/1 BANK/ALL. Selecting 1 BANK will save only bank A.
 - Press the PERFORM button to select all the performance data, or press the BACKUP button to select all the back up data at once.
 - If the ALL OFF button is pressed, all the settings change to NO.
3. Press the SAVE button.
 - The SAVE operation begins.

<SEQUENCER SONG SAVE>

You can specify a single song in the **SEQUENCER** to save to the SD card.

1. Use the **PAGE** buttons to access the 3/3 display.
 - The display looks similar to the following.



2. Use the buttons below the display to select the song number you wish to save.
3. Press the SAVE button.
 - The SAVE operation begins.

MEMO

You can save data on an SD card within the limits as follows.

- Maximum number of folders: 99
- Maximum number of songs in a folder: 20
- Maximum number of letters for the song or folder name: 16

■ SD-SOUND (SMF) FORMAT

This instrument's **SEQUENCER** data can be saved in the SD-SOUND format. SD-SOUND data can be converted to the "Standard MIDI File" (SMF Format 0) format for use on other instruments.

- What you can save in the SMF format (FORMAT 0) is ordinary performance data, such as note data. Data such as chord and rhythm data, **COMPOSER** data, etc. is not saved. If you wish to also save this special Technics data, save the data in the Technics File format.
- If you use the APC TO SMF CONVERT function of the **SEQUENCER**, you can convert the patterns of the automatic accompaniment, etc. to SMF data. (Refer to page 100.)



1. To overwrite a song number that already has data, use the buttons below the display to select the song number you wish to save to.
2. If you wish to assign a name to the file, press the NAME button.
3. Use the buttons below the display to assign a name.
4. Press the OK button.
 - The display returns to the SAVE display.

(Continued on the next page)

5. Use the FROM SONG buttons to select the **SEQUENCER** song number you wish to save.
 - The song name to save from is shown below the FROM SONG button.

6. Use the PANEL HEADER buttons to specify ON or OFF.

ON:

The sound and volume settings for each part are saved as data at the beginning of the file.

OFF:

This data is not saved.

7. Use the 1 MEASURE SPACE buttons to select ON or OFF.

ON:

A one-measure space is added to the beginning of the file.

OFF:

No space is added.

- When there is various data other than performance data stored at the beginning of a file, the start of playback may be delayed. This can be avoided by set the 1 MEASURE SPACE to ON to inserting a before the beginning of the performance.
- When set to ON, a space is added each time a file is saved. Therefore, if you have already saved a file once with the 1 MEASURE SPACE set to ON, please set it to OFF each time the file is subsequently saved.

8. Use the SAVE AS button to select the sound generator mode (GM/GM2/NX).

9. Press the SAVE button.

- The SAVE operation begins.
- When the operation has been successfully completed, "COMPLETED!" is shown on the display.
- If you attempt to save data to a file number in which data is currently saved, the display changes to the confirmation display. Select the type of data saving.

AT CURSOR LOCATION:

The song is saved to where the cursor is currently located (overwrite).

AT A NEW LOCATION:

The song is saved as a newly added data with the last song number.

Create an album of your favorite songs

The FAVORITE SONGS display allows you to create an album of your favorite songs which are aligned in a desired order, making it easy to load your favorite song to play back immediately.

FAVORITE SONGS

1. Insert the SD card which contains the songs into the SD slot.
2. Press the **SD** button to turn it on.
3. On the SD MENU display, select FAVORITE SONGS.
 - The display looks similar to the following.



4. Use the ▲ and ▼ buttons to select the BANK to use.
 - Press the +10 button to jump up to the next group of 10 selections, press the -10 button to jump down a group.
5. Press the FAVORITE SETTING button.
 - The display looks similar to the following.



6. Select the song.
 - The TECHNICS files and SD-SOUND songs are selected differently.
7. Press and hold the SET button, and select the location to put the song.
8. Press the BANK NAMING button to name the BANK.
9. Repeat the steps 5 and 6.
10. When you have finished making the settings, press the OK button.

■ Recalling the FAVORITE SONGS display

1. On the SD MENU display, select FAVORITE SONGS.
2. Select the BANK.
3. Select the song.
 - The load operation begins.

SD card management

Various SD card management procedures, such as file delete, file copy, card format, and file rename are available from the SD TOOLS menu.

SD TOOLS

1. Insert the SD card to manage into the SD slot.
2. Press the **SD** button to turn it on.
3. On the SD MENU display, select SD TOOLS.
 - The display looks similar to the following.



4. Select a function and follow the procedure to execute it.
 - You can press the SD-SOUND/TECH button to change to the display for setting relevant file types.
 - If you press the FORMAT button, the display changes to the format display for SD CARD. (The current contents of the SD card are erased when the card is formatted.)

TECH TOOLS

SONG DELETE:

Delete a song.

SONG/FOLDER RENAME:

Change the name of a SONG or FOLDER.

COPY:

Copy songs on the SD card. Specify the FOLDER first and then the SONG to copy to.

SD-SOUND TOOLS

SONG DELETE:

When selecting a PLAYLIST other than the DEFAULT PLAYLIST, the specified SONG will be deleted from all the PLAYLISTS.

SONG RENAME:

Change the name of a SONG.

SD-SOUND EXPORT:



Convert SD-SOUND data to generic SMF data for use on an external instrument.

- SONGs in a specified PLAYLIST except for DEFAULT PLAYLIST are exported to the "IMEXPORT" directory at one time.
- Pressing ALL DELETE will delete all files; however, "read only" files will not be deleted.

SD-SOUND IMPORT:



Convert SMF data on the SD card to SD-SOUND data for use on this instrument.

- SMF files in the "IMEXPORT" directory are imported as SD-SOUND data, and they are used to create a new PLAYLIST.
- Specify the SMF files you wish to import using the SEL buttons. A "*" mark is shown on the selected files.

Set the priority of displays

Specify the desired priority of displays when the LOAD button is pressed on the control panel.

SD PREFERENCES

1. On the SD MENU display, select SD PREFERENCES.
 - The display looks similar to the following.

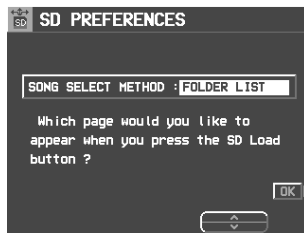

2. Use the \wedge and \vee buttons to choose the SONG SELECT METHOD.
 - Specify the top priority of the type of LOAD displays, when LOAD is selected on the SD MENU display (FOLDER LIST/LOAD BY NUMBER/ALPHABET SORT/SD-SOUND LOAD).
3. Press the OK button.

Part VIII Sound

Outline of the Sound

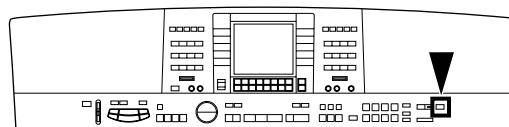

The **SOUND** mode is used for making fine adjustments to the functions related to sound, such as tone, and tuning.

1. Press the **PROGRAM MENUS** button to turn it on.

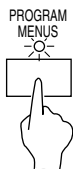

- The display looks similar to the following.

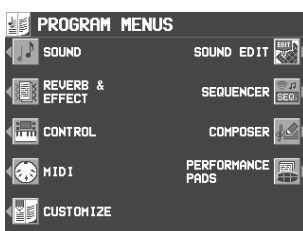

2. Select **SOUND**.

 - The display looks similar to the following.

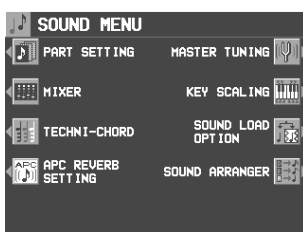

3. Select the desired menu.

Summary of the **SOUND** menu items

- PART SETTING** (page 147)
Set the various sound attributes for each part.
- MIXER** (page 150)
Use the **MIXER** display to visually adjust the major settings of each part.
- MASTER TUNING** (page 152)
Select the type of tuning for the instrument.
- KEY SCALING** (page 152)
Select the type of scaling (tuning).
- SOUND LOAD OPTION** (page 153)
Specify whether the various data accompanying a sound, such as effects, are used when the sound is recalled.

4. Follow the procedures on the corresponding menu display.

- When the **TEMPO/PROGRAM** indicator is lit, it indicates that the **TEMPO/PROGRAM** is available for setting the current function.

5. When you have finished setting the functions, press the **PROGRAM MENUS** button to turn it off.

■ A word about parts

The organization of the sound parts is as follows.

Normal parts:

RIGHT 1, RIGHT 2, LEFT, PART 1 to 16

- It is suggested that **PART 10** be used for the **DRUMS** part.

AUTO PLAY CHORD (automatic accompaniment) parts:

ACCOMP 1–5, BASS, DRUMS 1, 2, CHORD, R.BASS.

PERFORMANCE PADS part:
PADS

TECHNI-CHORD

Select the **TECHNI-CHORD** harmony style. (Refer to page 47.)

APC REVERB SETTING (page 154)

Adjust the degree of **REVERB** for each automatic accompaniment part.

SOUND ARRANGER

Changes the sound of each automatic accompaniment part. (Refer to page 59.)

Part Setting

Set the various sound attributes for each part.

Selecting an attribute

1. On the SOUND MENU display, select PART SETTING.
2. Use the PART SELECT \wedge and \vee buttons to select the part.

3. Use the buttons below the display to adjust each attribute (explained in detail following).

- The settings display is comprised of 5 pages. Use the **PAGE** buttons to switch pages.
- When you have completed adjustment of an attribute, use the buttons along the bottom of the display to select the next attribute you wish to adjust.

4. When you have completed adjusting all of the settings for one part, select another part and repeat the adjustment procedure as desired.

- The settings and effects of the PAN, EFFECT etc. may differ depending on the sound.

<PAGE 1>

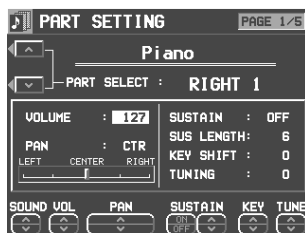

SOUND:

Use the SOUND \wedge and \vee buttons to select a sound.

- The buttons on the control panel may also be used to select a sound.

VOLUME:

Use the VOL \wedge and \vee buttons to adjust the volume (0 to 127).

PAN:

Use the PAN \wedge and \vee buttons to adjust the stereo balance (L64–CENTER(CTR)–R63).

- At L64, the sound is completely to the left, at R63 completely to the right. At CENTER, the sound is at the center. The display indicates the selected position.
- Even at the same numerical value, the stereo balance may differ slightly depending on the sound.

SUSTAIN:

Use the SUSTAIN ON/OFF buttons to enable or disable the **SUSTAIN** function.

Use the \wedge and \vee buttons to adjust the length of the sustain.

KEY SHIFT:

Use the KEY \wedge and \vee buttons to specify the amount of key shift (–24 to +24).

- A value of 1 means a shift of one semi-tone. To raise (or lower) the pitch one octave, set the value to +12 (or –12).
- The \vee button is used to lower the pitch, and the \wedge button to raise the pitch.

TUNING:

Use the TUNE \wedge and \vee buttons to adjust the fine tuning (–128 to +127).

- The \vee button is used to lower the pitch, and the \wedge button to raise the pitch.

<PAGE 2>

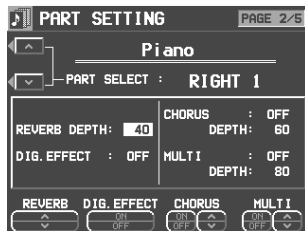
**REVERB:**

Use the REVERB \wedge and \vee buttons to adjust the depth of the **REVERB** (0 to 127).

DIGITAL EFFECT:

Use the DIG. EFFECT ON/OFF buttons to set the **DIGITAL EFFECT** to on or off.

CHORUS:

Use the CHORUS ON/OFF button to set the **CHORUS** to on or off. Use the \wedge and \vee buttons to adjust the depth of the effect (0 to 127).

MULTI:

Use the MULTI ON/OFF button to set the **MULTI EFFECT** to on or off. Use the \wedge and \vee buttons to adjust the depth of the effect (0 to 127).

<PAGE 3>

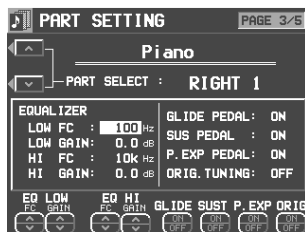
**EQ LOW:**

Use the EQ LOW FC, GAIN \wedge and \vee buttons to adjust the sound quality in the lower range.

EQ HIGH:

Use the EQ HIGH FC, GAIN \wedge and \vee buttons to adjust the sound quality in the upper range.

GLIDE PEDAL:

Use the GLIDE ON/OFF buttons to enable or disable the glide effect, if it has been assigned to the Foot Switch (sold separately).

- For Foot Switch settings, refer to page 172.

SUSTAIN PEDAL:

Use the SUST ON/OFF buttons to enable or disable the sustain effect, if it has been assigned to the Foot Switch (sold separately).

PART EXP PEDAL:

Use the EXP PDL ON/OFF buttons to enable or disable part expression by the expression pedal (sold separately).

- To enable the ON/OFF setting for each part, it is necessary to set EXPRESS. PEDAL to PART EXPRESSION on the FOOT CONTROLLERS display. (Refer to page 173.)

ORIGINAL TUNING:

Use the ORIG ON/OFF button to enable or disable the tuning for each sound.

- For details about ORIGINAL TUNING, refer to page 152.

<PAGE 4>

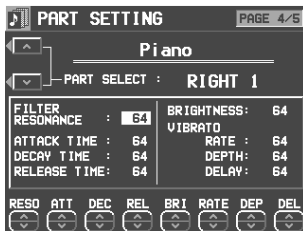
**FILTER RESONANCE:**

Use the RESO \wedge and \vee buttons to adjust the amount of resonance (0 to 127).

ATTACK TIME:

Use the ATT \wedge and \vee buttons to specify the attack time (0 to 127).

DECAY TIME:

Use the DEC \wedge and \vee buttons to specify the decay time (0 to 127).

RELEASE TIME:

Use the REL \wedge and \vee buttons to specify the release time (0 to 127).

BRIGHTNESS:

Use the BRI \wedge and \vee buttons to adjust the brightness of the sound (0 to 127).

VIBRATO RATE:

Use the RATE \wedge and \vee buttons to specify the vibrato speed (0 to 127).

VIBRATO DEPTH:

Use the DEP \wedge and \vee buttons to specify the vibrato depth (0 to 127).

VIBRATO DELAY:

Use the DEL \wedge and \vee buttons to specify the time interval from when the keys are played until the vibrato starts (0 to 127).

- The center value is 64 (± 0).

<PAGE 5>

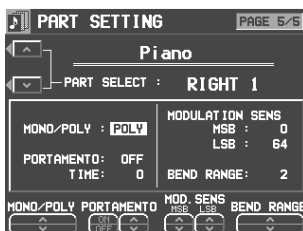
**MONO/POLY MODE:**

Use the MONO/POLY \wedge and \vee buttons to select the output mode.

PORTAMENTO:

Use the PORTAMENTO ON/OFF buttons to enable or disable the portamento function. (Portamento is a continuous gliding movement from one tone to another.)

Use the \wedge and \vee buttons to specify the portamento time.

- PORTAMENTO does not function for the POLY MODE.

MODULATION SENSITIVITY:

Use the MOD SENS \wedge and \vee buttons to adjust the sensitivity of the MODULATION.

- Use the MSB \wedge and \vee buttons (half-tone increments) and the LSB \wedge and \vee buttons to adjust the setting.

BEND RANGE:

Use the BEND RANGE \wedge and \vee buttons to specify the PITCH BEND range (0 to 12). Increments are in semi-tones.

- The higher the number, the greater the change in pitch when the **PITCH BEND** wheel is operated.

Mixer

Use the MIXER display to visually adjust the major settings of each part. Use this display to make broad, general changes to the settings.

- On the SOUND MENU display, select MIXER.
 - The MIXER display consists of 5 pages. Use the **PAGE** buttons to switch among the pages.
 - Each time the **OTHER PARTS/TR** button is pressed, the part that is displayed changes.
- Adjust each parameter.

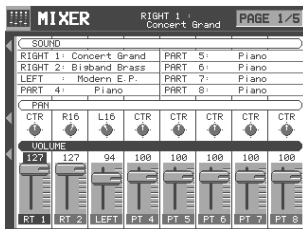

SOUND:

Select SOUND. Use the buttons below the display to set the sound for the corresponding part.

- The buttons in the **SOUND GROUP** can also be used to select the sound.

PAN:

Select PAN. Use the buttons below the display to adjust the stereo balance of the corresponding part (L64–CTR–R63).

VOLUME:

Select VOLUME. Use the buttons below the display to adjust the volume of the corresponding part (0 to 127).

- To mute a part, press both the corresponding balance buttons as the same time. To cancel the mute, press either balance button for the part.

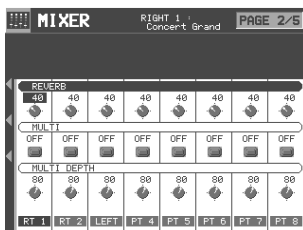

REVERB:

Select REVERB. Use the buttons below the display to set the level of the **REVERB** for the corresponding part (0 to 127).

MULTI:

Select MULTI. Use the buttons below the display to set the **MULTI EFFECT** to ON or OFF for each part.

MULTI DEPTH:

Select MULTI DEPTH. Use the buttons below the display to adjust the depth of the **MULTI EFFECT** for the corresponding part (0 to 127).

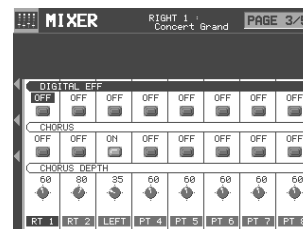

DIGITAL EFFECT:

Select DIGITAL EFF. Use the buttons below the display to set the **DIGITAL EFFECT** to ON or OFF for the corresponding part.

CHORUS:

Select CHORUS. Use the buttons below the display to set the **CHORUS** to ON or OFF for each part.

CHORUS DEPTH:

Select CHORUS DEPTH. Use the buttons below the display to set the depth of the **CHORUS** for the corresponding part (0 to 127).

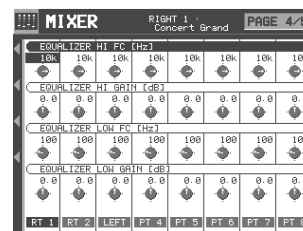

EQUALIZER HIGH:

Sound quality correction in the high range. Select EQUALIZER HI FC; use the buttons below the display to set the standard frequency. Select EQUALIZER HI GAIN; use the buttons below the display to set the ratio of change.

EQUALIZER LOW:

Sound quality correction in the low range. Select EQUALIZER LOW FC; use the buttons below the display to set the standard frequency. Select EQUALIZER LOW GAIN; use the buttons below the display to set the ratio of change.

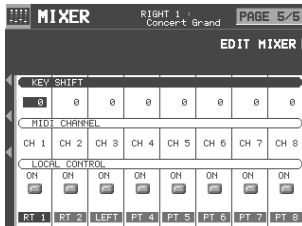
**KEY SHIFT:**

Select KEY SHIFT. Use the buttons below the display to adjust the shift width of the output pitch of each part (in semitone increments; -24 to +24).

MIDI CHANNEL:

Select MIDI CHANNEL. Use the balance buttons below the display to set the MIDI channel for each part (CH1–CH16).

- Information about MIDI channels can be found on page 190.

LOCAL CONTROL:

Select LOCAL CONTROL. Use the balance buttons below the display to turn LOCAL CONTROL ON or OFF for each part.

- Even at the same numerical value, the PAN and effects may differ depending on the sound.
- For some parts, such as the automatic accompaniment parts, the items that can be adjusted are limited.

■ EDIT MIXER

If you press the EDIT MIXER button on the PAGE 5/5 display, the display changes the setting display to modify the sounds.

<PAGE 1>

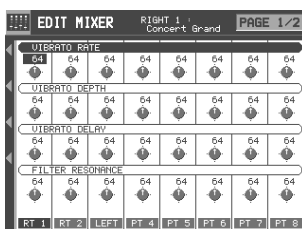
**VIBRATO RATE:**

Select VIBRATO RATE. Use the buttons below the display to adjust the vibrato speed for each part (0 to 127).

VIBRATO DEPTH:

Select VIBRATO DEPTH. Use the buttons below the display to adjust the vibrato depth for each part (0 to 127).

VIBRATO DELAY:

Select VIBRATO DELAY. Use the buttons below the display to specify the time interval from when the keys are played until the vibrato starts for each part (0 to 127).

FILTER RESONANCE:

Select FILTER RESONANCE. Use the buttons below the display to set the amount of resonance applied to each part (0 to 127).

<PAGE 2>

BRIGHTNESS:

Select BRIGHTNESS. Use the buttons below the display to set the amount of brightness applied to each part (0 to 127).

ATTACK TIME:

Select ATTACK TIME. Use the buttons below the display to set the sound attack time for each part (0 to 127).

DECAY TIME:

Select DECAY TIME. Use the buttons below the display to set the sound decay time for each part (0 to 127).

RELEASE TIME:

Select RELEASE TIME. Use the buttons below the display to set the release time for each part (0 to 127).

Master Tuning

This setting is used to fine-tune the pitch of the entire instrument. This is convenient when the Keyboard is played with other instruments or with a recorded performance.

1. On the SOUND MENU display, select MASTER TUNING.
 - The display changes to the following.

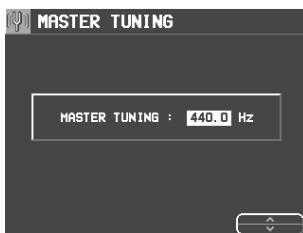

2. Use the \wedge and \vee buttons to adjust the pitch.

Key Scaling

For each part you can change the tuning of each key within a one-octave range. In addition to equal temperament tuning, you can perform in other types of scales, for example Arabic tuning.

1. On the SOUND MENU display, select KEY SCALING.
 - The display looks similar to the following.

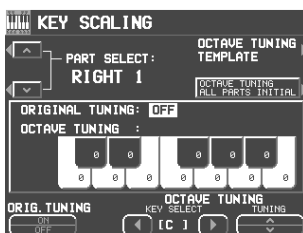

2. Press the OCTAVE TUNING TEMPLATE button.
 - The display looks similar to the following.

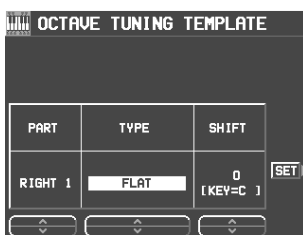

3. Use the PART \wedge and \vee buttons to select the part to set.
 - If ALL is selected, all the parts are set at once.

4. Use the TYPE \wedge and \vee buttons to select the type of tuning.
 - Select from FLAT, WERCKMEISTER, KIRNBERGER, ARABIC 1 to 5, SLENDRO, and PELOG.

5. Use the SHIFT \wedge and \vee buttons to select the key to perform in.

6. Repeat steps 3 to 5 for each part, as necessary.

7. Press the SET button.

- The OCTAVE TUNING for the specified type and key is automatically set.

■ Settings for each key.

On the KEY SCALING display, you can adjust the tuning for each key.

After selecting a key with the KEY SELECT \blacktriangleleft and \blacktriangleright buttons, the pitch can be adjusted using the TUNING \wedge and \vee buttons.

- The pitch can be raised or lowered by a maximum of one half-tone.
- You can use the PART SELECT \wedge and \vee buttons to switch the part.
- Use the ALL PARTS INITIAL button to return all parts to the flat tuning.

■ ORIGINAL tuning

Each instrument of each sound has its own original tuning data. This setting affects the tuning curve that spans the entire keyboard. So, for example, the acoustic piano-type sounds duplicate those of a real piano, in that the high notes are tuned slightly higher and the low notes slightly lower.

You can specify for each part whether this original tuning is enabled or not.

1. Use the PART SELECT \wedge and \vee buttons to select a part.
2. Use the ORIGINAL TUNING ON/OFF button to select ON or OFF.

Sound Load Option

The data for each individual sound is set with the most suitable effect settings, etc., but in some cases when switching from one sound to another and these settings are recalled, the setup is not the way you want it. By using the SOUND LOAD OPTION, you can adjust the settings so that specific data is not recalled.

1. On the SOUND MENU display, select SOUND LOAD OPTION.
 - The display looks similar to the following.

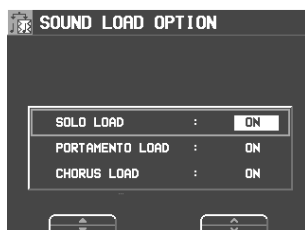

2. Use the \blacktriangle and \blacktriangledown buttons to select an item. Use the \wedge and \vee button to set the filter to ON or OFF.

APC Reverb Setting

Although an appropriate REVERB is applied for the automatic accompaniment parts depending on the rhythms by default, you can adjust the REVERB level for each part.

1. On the SOUND MENU display, select APC REVERB SETTING.
 - The display looks similar to the following.

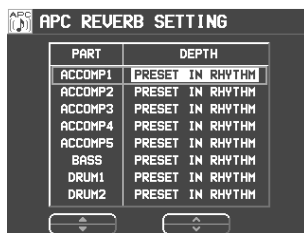

2. Use the PART ▲ and ▼ buttons to select the part, the DEPTH ^ and v buttons to set the value (PRESET IN RHYTHM, 0 – 127).
 - PRESET IN RHYTHM is an optimal preset value for each rhythm for use with the APC Reverb Setting.

Part IX Reverb & Effect

Outline of the Reverb & Effect

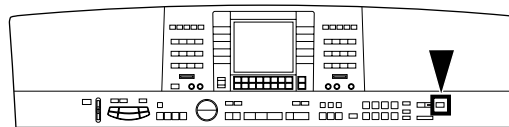

In the REVERB & EFFECT mode, you can make detailed settings related to this instrument's effects.

1. Press the **PROGRAM MENUS** button to turn it on.

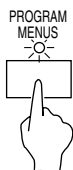

- The display looks similar to the following.



2. Select REVERB & EFFECT.
- The display looks similar to the following.



3. Select the desired menu.
4. Follow the procedures on the corresponding menu display.
 - When the **TEMPO/PROGRAM** indicator is lit, it indicates that the **TEMPO/PROGRAM** is available for setting the current function.
5. When you have finished setting the functions, press the **PROGRAM MENUS** button to turn it off.

Summary of the REVERB & EFFECT menu items

TONE CONTROL (page 156)

Settings for the entire instrument's final output sound quality.

REVERB:

REVERB type and detailed settings (page 43)

CHORUS:

CHORUS type and detailed settings (page 43)

MULTI:

MULTI EFFECT type and detailed settings (page 42)

MIC REVERB & EFFECT:

Settings for the effects that are applied to MIC. (page 44)

SOUND LOAD OPTION:

Specify whether the various data accompanying a sound, such as effects, are used when the sound is recalled. (page 153)

MIXER:

Use the MIXER display to visually adjust the major settings of each part. (page 150)

Tone Control

Settings for the entire instrument's final output sound quality.

1. On the REVERB & EFFECT display, select TONE CONTROL.
 - The display looks similar to the following.



2. Use the BASS \wedge and \vee buttons to adjust the low range and the TREBLE \wedge and \vee buttons for the high range.
 - Raising the settings excessively may cause distorted sounds. Lower the setting or the MAIN VOLUME.

Part X Sound Edit

Outline of the Sound Edit

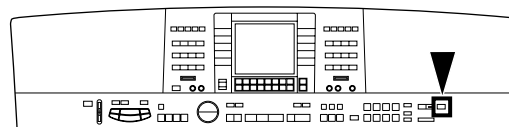

SOUND EDIT enables you to create your own new sound by altering one of the this instrument's preset sounds. Your new sound can be stored in one of the sound memory locations. SOUND EDIT has two methods of use. You can edit in detail using functions more commonly associated with a synthesizer, or you can use EASY EDIT which allows you to change some basic parameters on one page.

1. Select a sound to edit.
2. Turn on the **PROGRAM MENU** button.

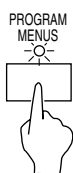

- The display looks similar to the following.

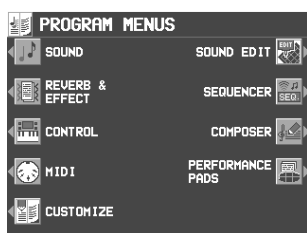

3. Select SOUND EDIT.
- The display looks similar to the following.



4. Select the desired menu and follow the procedures on the corresponding setting display.
 - To check the sound of a single tone, press the SOLO button to highlight the SOLO indication. Only the currently selected tone sounds when a key is played.
 - When the **TEMPO/PROGRAM** indicator is lit, it indicates that the **TEMPO/PROGRAM** is available for setting the current function.
5. When the sound is just the way you like it, on the SOUND EDIT MENU display press the WRITE button to store your new sound.

- Press the EDITED (or ORIGINAL) button to switch between the modified sound (EDITED) and the original sound (ORIGINAL). This allows you to compare the edited sound to the original sound as you are modifying it.

Summary of the SOUND EDIT menu items

EASY EDIT (page 158)

The most often used edit functions—such as brightness and attack speed—are assembled on one display for easy sound modification.

TONE (page 159)

Modify the tones which make up the sound.

PITCH (page 162)

Adjust the settings related to the pitch.

FILTER (page 163)

Adjust the amount of frequency cut in specific frequency ranges.

AMPLITUDE (page 165)

Volume settings.

LFO (page 167)

Cyclic modulation settings.

EFFECT (page 168)

Settings related to the various effects applied to the sound.

CONTROLLER (page 169)

Specify how wheel operation etc. affects the sound.

- When DRUM KIT sounds are selected and the SOUND EDIT is activated, the setting display looks different from that for other sounds, but the basic operation is the same. (To specify the percussion instrument you wish to edit, use the \wedge and \vee buttons to select the sound name, or alternatively, while pressing the keyboard key for the corresponding sound, press the NOTE SELECT button.)
- To record the DIGITAL DRAWBAR settings, first adjust the settings, then enter the SOUND EDIT mode, press the WRITE button and follow the procedure on the display.

Easy Edit

The most commonly used edit functions are consolidated on one display, providing convenient and quick editing operation.

1. On the SOUND EDIT menu display, select EASY EDIT.
- The display changes to the following.



2. Use the buttons below the display to specify the value of the attribute.
 - An effect may remain unchanged when EASY EDIT is used to set the value, if another EDIT function was first used to set the value to its upper or lower limit.
3. Press the WRITE button to store your new sound.
 - Storing your new sound is explained on page 169.
 - If a sound is stored in the EASY EDIT mode, and is later selected in the EASY EDIT mode, the displayed value of an attribute may be different from the value when it was stored. The sound itself, however, is exactly as it was stored.

Easy Edit items

BRILLIANCE:

Adjust the brightness of the sound.

VIBRATO DEPTH:

Set vibrato depth.

VIBRATO SPEED:

Set vibrato speed.

VIBRATO DELAY:

Set time delay between key played and vibrato start.

OCT SHIFT:

Shift the octave range.

ATTACK:

Adjust attack time.

RELEASE:

Adjust time of sound fade-out after key is released.

D. EFF:

Select type of effect. (Refer to page 168)

Tone Edit

Modify the separate tones which comprise the sound.

About tones

A sound may be made up of at most four tones.

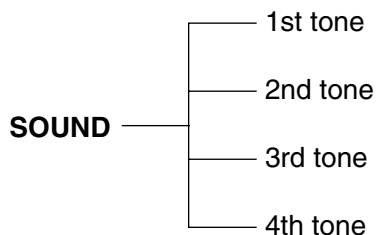

- A special process is used to produce real-sounding piano type tones. For this reason, some edit procedures for piano sounds, FILTER or AMPLITUDE for example, may differ from those for other sounds.

TONE SELECT

1. On the SOUND EDIT menu, select TONE.
 - The display looks similar to the following.

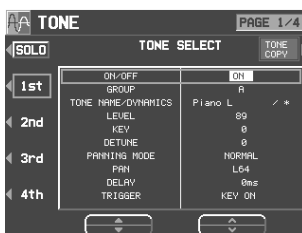

2. Use the buttons to the left of the display to select the tone you wish to edit (1st, 2nd, 3rd, 4th).
 - Use the ▲ and ▼ buttons to select a setting item and then the ^ and v buttons to specify a selection.
 - Use the ON/OFF buttons to select ON or OFF.
3. Select a sound for the tone.
 - Use the GROUP ^ and v buttons to select the group, and the TONE NAME ^ and v buttons to select the sound.
 - A “*” mark in the DYNAMICS column indicates that a TONE DYNAMICS change was made to the sound.
4. Use the LEVEL ^ and v buttons to adjust the volume.
5. Use the KEY ^ and v buttons to set the pitch of the output sound.
6. Use the DETUNE ^ and v buttons for fine adjustment of the pitch deviation.

7. Use the PANNING MODE ^ and v buttons to select mode. (NORMAL, RANDOM, STEREO R, STEREO L)
 - If STEREO R or STEREO L is selected for the MODE, the balance is fixed (cannot be moved).
8. Use the PAN ^ and v buttons to adjust the stereo balance.
 - CTR is the center point. At L64, the sound is all the way to the left, at R63 all the way to the right.
9. Use the DELAY ^ and v buttons to adjust the delay time of the sound.
 - The higher the number, the longer the delay before sound output.
10. Use the TRIGGER ^ and v buttons to select a trigger mode.

KEY ON:

The normal mode, in which sound is emitted when the key is played.

KEY OFF:

Sound is emitted when the key is released (like muted strings, for example).

LEGATO:

Sound is emitted only when the key is played legato.

NON LEG:

Sound is not emitted when the key is played legato.

PEDAL:

The sound is produced only while the **SUSTAIN** button is on.

CHORD:

The sound is emphasized when chords are played (like the cutting sound of a guitar, for example).

■ TONE COPY

You can copy the tone of a particular sound to a specified tone in the sound you are editing.

1. On the 1/4 display, press the TONE COPY button.
2. Use the FROM \wedge and \vee buttons to select the tone to copy from.
 - Use the OPTION \wedge and \vee buttons to select the item you wish to copy.
3. Use the TO \wedge and \vee buttons to select the tone you wish to copy to.
4. Press the OK button.
 - Tone copy is executed.

KEY LAYER

Adjust the relation of tone output to keyboard location.

1. Use the **PAGE** buttons to view the 2/4 display.
 - The display looks similar to the following.

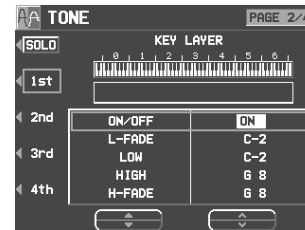

2. Use the buttons to the left of the display to select a tone (1st, 2nd, 3rd or 4th).
 - Use the \blacktriangle and \blacktriangledown buttons to select a setting item and then the \wedge and \vee buttons to specify a selection.
3. Use the L-FADE \wedge and \vee buttons and the LOW \wedge and \vee buttons to define the area of the lower range of tone output.
 - By entering different values for the L-FADE and LOW settings, you can define a sloping volume increase to the peak output volume which corresponds to the note pitch.
4. Use the HIGH \wedge and \vee buttons and the H-FADE \wedge and \vee buttons to define the area of the higher range of tone output.
 - By entering different values for the H-FADE and HIGH settings, you can define a sloping volume decrease from the peak output volume which corresponds to the note pitch.
 - By overlapping the L-FADE and H-FADE curves of each different tone, you can achieve a cross-fade effect, where the sound gradually changes in relation to pitch.
5. Repeat steps 2 to 4 for the other tones, as desired.

VELOCITY LAYER

Adjust these settings to regulate the tone output relative to the velocity.

1. Use the **PAGE** buttons to view the 3/4 display.
 - The display looks similar to the following.

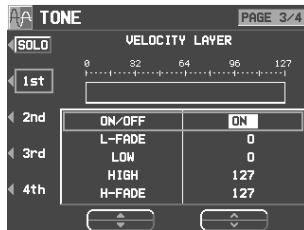

2. Use the buttons to the left of the display to select a tone (1st, 2nd, 3rd or 4th).
 - Use the ▲ and ▼ buttons to select a setting item and then the ^ and v buttons to specify a selection.
3. Use the L-FADE ^ and v buttons and the LOW ^ and v buttons to define the *pp* sound output area for the lower range.
4. Use the HIGH ^ and v buttons and the H-FADE ^ and v buttons to define the *ff* sound output area for the higher range.
 - By overlapping the L-FADE and H-FADE curves of each different tone, you can change the way the tone sounds relative to how hard or softly the keyboard is played.
5. Repeat steps 2 to 4 for the other tones, as desired.

TONE DYNAMICS

You can adjust the settings so that a different sound (tone) is output for each tone depending on the velocity (how hard the keys are played).

1. Use the **PAGE** buttons to view the 4/4 display.
 - The display looks similar to the following.



2. Use the buttons to the left of the display to select a tone.
3. Use the ▲ and ▼ buttons to select the column for the function you wish to adjust.
4. Select the tone waveform.
 - Use the GR ^ and v buttons to select the sound group. Use the TONE WAVEFORM ^ and v buttons to select the waveform.
5. Use the LEV ^ and v buttons to adjust the volume. Use the FLT ^ and v buttons to set the sound.
6. Use the VELOCITY ^ and v buttons to specify the velocity range.
 - When the upper limit of a waveform is set to 127, no more waveforms can be added.
7. Repeat steps 3 to 6 to edit the other waveforms, as desired.
8. Repeat steps 2 to 7 for the other tones, as desired.

Pitch Edit

Adjust the settings related to the pitch of the sound.

KEY SHIFT & DETUNE

1. On the SOUND EDIT menu display, select PITCH.
 - The display looks similar to the following.

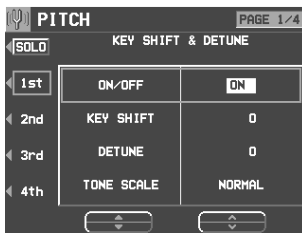

2. Use the buttons to the left of the display to select a tone (1st, 2nd, 3rd or 4th).
 - Use the ▲ and ▼ buttons to select a setting item and then the ^ and v buttons to specify a selection.
3. Use the KEY SHIFT ^ and v buttons to specify the output pitch.
 - Units are in semitones.
4. Use the DETUNE ^ and v buttons to fine-adjust the pitch.
 - Slight differences in the DETUNE values between the tones add fullness to the sound.
5. Use the TONE SCALE ^ and v buttons to select the type of scale (NORMAL, 1/2, 1/4, 1/8, 1/16, 1/32, 1/64, FIX).
 - NORMAL is the normal scale type. For example, when 1/2 is selected, a difference in pitch between one key and the adjacent key becomes half the normal pitch difference. When FIX is selected, the pitch is the same regardless of which key is played.

KEYBOARD OCTAVE

1. Use the PAGE buttons to view the 2/4 display.
 - The display looks similar to the following.



2. Use the OCT SHIFT ^ and v buttons to set the octave of the sound.

3. Use the RIGHT SPLIT ^ and v buttons to set the octave of the right part when the keyboard is split.

4. Use the LEFT SPLIT ^ and v buttons to set the octave of the left part when the keyboard is split.

PITCH ENVELOPE

Specify how the pitch changes over time, from the time the key is played to the time the sound dies out.

1. Use the PAGE buttons to view the 3/4 display.
 - The display looks similar to the following.



2. Use the buttons to the left of the display to select a tone.
 - Use the ▲ and ▼ buttons to select a setting item and then the ^ and v buttons to specify a selection.
3. Adjust the settings for the pitch change envelope.
 - Use the buttons below the display to set the corresponding values. The envelope is created on the display as you input the settings.
 - Use the TOTAL DEPTH ^ and v buttons to specify the maximum level.
 - Use the START PITCH ^ and v buttons to set the start point. Use the STOP PITCH ^ and v buttons to set the stop point.
4. Repeat steps 2 and 3 for the other tones, as desired.

PITCH ENVELOPE TOUCH & KEY FOLLOW

Specify how the pitch envelope changes in relation to note pitch.

1. Use the **PAGE** buttons to view the 4/4 display.



2. Use the buttons to left of the display to select a tone.

- Use the ▲ and ▼ buttons to select a setting item and then the ^ and v buttons to specify a selection.

3. Use the TOUCH ^ and v buttons to change the respective touch settings.

- Use the TIME ^ and v buttons to specify the time change depending on touch. Use the LEVEL ^ and v buttons to specify the pitch change level depending on touch.

- At a – setting, the softer the keys are pressed, the greater the change. At a + setting, the harder the keys are pressed, the greater the change.

4. Change the key follow settings for the ATTACK, DECAY and RELEASE.

- Use the ^ and v buttons corresponding to the ENVELOPE KEY FOLLOW attributes to adjust the settings. Use the CENTER ^ and v buttons to select the center of the bend direction.

Filter Edit

Make major changes to the sound by eliminating specific frequency ranges.

FILTER & EQUALIZER

1. On the SOUND EDIT menu, select FILTER.

- The display looks similar to the following.

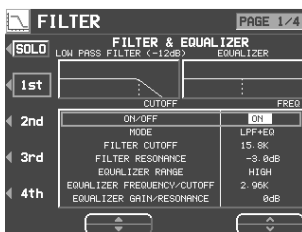

2. Use the buttons to the left of the display to select a tone.

- Use the ▲ and ▼ buttons to select a setting item and then the ^ and v buttons to specify a selection.

3. Use the MODE button to select the filter mode.

LPF(6)+EQ (low-pass filter + equalizer)

Signals higher than the cut-off frequency are cut. Normal sounds are softened.

HPF(6)+EQ (high-pass filter + equalizer)

Signals lower than the cut-off frequency are cut. Normal sounds are sharpened.

LPF24 (low-pass filter 24)

A stronger low-pass filter than LPF+EQ.

HPF24 (high-pass filter 24)

A stronger high-pass filter than HPF+EQ.

BPF (band-pass filter)

Cuts off signals that are not within in the area between the two specified CUTOFF frequencies.

- For this mode, adjust the settings on the EQUALIZER/FILTER side as well.

THRU

No filter effect is applied.

4. Use the CUTOFF \wedge and \vee buttons to set the frequency range which is cut by the filter.
5. Use the RESONANCE \wedge and \vee buttons to specify the resonance value (dB).
 - Resonance is effect which adds character to the sound by emphasizing the harmonic components of frequencies close to the cut-off frequency.

<Equalizer>

For LPF(6)+EQ/HPF(6)+EQ filters, the sound quality can be modified by the EQUALIZER.

RANGE

Select the setting range (HIGH or LOW).

FREQUENCY

Set the standard frequency.

GAIN

Set the level increase or decrease from the value set for FREQ (dB).

6. Repeat steps 2 to 5 for each tone, as desired.

TOUCH & KEY FOLLOW

Adjust how the filter is applied relative to touch and pitch.

1. Use the **PAGE** buttons to view the 2/4 display.
 - The display looks similar to the following.

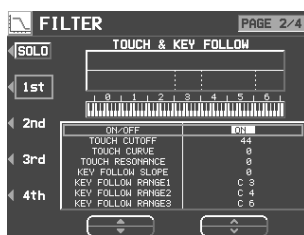

2. Use the buttons to the left of the display to select a tone.
 - Use the \blacktriangle and \blacktriangledown buttons to select a setting item and then the \wedge and \vee buttons to specify a selection.
3. Modify how the respective filters are applied relative to key touch.
 - Use the TOUCH CUT OFF \wedge and \vee buttons to specify the amount of change in the cut-off frequency. Use the TOUCH CURVE \wedge and \vee buttons to specify the curve of change. Use the TOUCH RESONANCE \wedge and \vee buttons to specify the degree of change in the resonance value.
4. Modify how the respective filters are applied relative to note pitch.
 - Use the KEY FOLLOW SLOPE \wedge and \vee buttons to adjust the bend slope. Use the KEY FOLLOW RANGE \wedge and \vee buttons to specify the pitch range.
5. Repeat steps 2 to 4 for the other tones, as desired.

FILTER ENVELOPE

Specify how the filter changes over time, from the time the key is played to the time the sound dies out.

1. Use the **PAGE** buttons view the 3/4 display.
 - The display looks similar to the following.

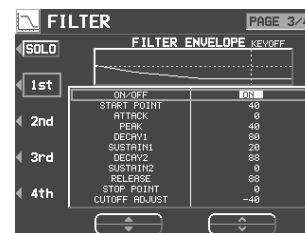

2. Use the buttons to the left of the display to select a tone.
 - Use the \blacktriangle and \blacktriangledown buttons to select a setting item and then the \wedge and \vee buttons to specify a selection.
3. Use the \wedge and \vee buttons to modify the respective filter envelopes.
 - Use the buttons below the display to adjust the respective settings.
 - You can use the CUTOFF ADJUST buttons to set the total upper and lower settings, the START POINT buttons to set the start point, and the STOP POINT buttons to set the stop point.
4. Repeat steps 2 and 3 for the other tones, as desired.

FILTER ENVELOPE TOUCH & KEY FOLLOW

Specify how the filter envelope (curve) changes relative to touch or note pitch.

- Use the **PAGE** buttons to view the 4/4 display.
 - The display looks similar to the following.

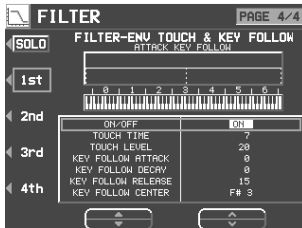

- Use the buttons to the left of the display to select a tone.
 - Use the ▲ and ▼ buttons to select a setting item and then the ^ and v buttons to specify a selection.

- Modify how the respective filter envelopes change relative to touch.

- Use the TOUCH TIME ^ and v buttons to specify the time change, and the TOUCH LEVEL ^ and v buttons to specify the level, relative to touch.
- At a – setting, the softer the keys are played, the greater the change. At a + setting, the harder the keys are played, the greater the change.

- Use the KEY FOLLOW ^ and v buttons to modify how the respective filter envelopes change relative to note pitch.
 - Adjust the respective slopes for attack, decay and release. Use the CENTER ^ and v buttons to specify the center of the bend slope by note name.

Amplitude Edit

Adjust the settings related to the volume of the sound.

LEVEL

- On the SOUND EDIT menu, select AMPLITUDE.
 - The display looks similar to the following.

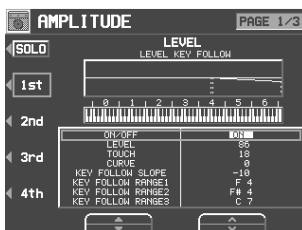

- Use the buttons to the left of the display to select a tone.
 - Use the ▲ and ▼ buttons to select a setting item and then the ^ and v buttons to specify a selection.

- Use the LEVEL ^ and v buttons to select the volume.

- Use the TOUCH ^ and v buttons to set the amount of volume change in relation to how hard the keyboard is played.
 - At a – value, the softer the keyboard is played, the louder the sound. At a + value, the harder the keyboard is played, the louder the sound.

- Use the CURVE ^ and v buttons to select the type of volume curve depending on touch.

- Change the respective key follow settings.
 - Use the KEY FOLLOW SLOPE ^ and v buttons to adjust the bend slope. Use the KEY FOLLOW RANGE (1–3) ^ and v buttons to specify the pitch range by note name.

- Repeat steps 2 to 6 for the other tones, as desired.

ENVELOPE

Specify how the volume changes over time, from the time the key is played to the time the sound dies out.

1. Use the **PAGE** buttons to view the 2/3 display.
 - The display looks similar to the following.

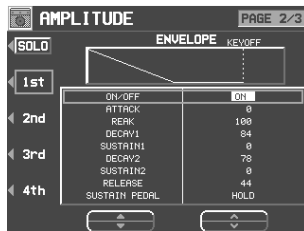

2. Use the buttons to the left of the display to select a tone.
 - Use the ▲ and ▼ buttons to select a setting item and then the ^ and v buttons to specify a selection.
3. Adjust the settings for the volume envelope.
 - Use the buttons below the display to set the corresponding values. The envelope is created on the display as you input the settings.
 - Use the SUSTAIN PEDAL ^ and v buttons to select the type of sustain.

LONG:

Extend the release time of the sound.

HOLD:

Maintain the key-pressed condition.

4. Repeat steps 2 and 3 for the other tones, as desired.

ENVELOPE TOUCH & KEY FOLLOW

Specify how the volume changes relative to touch or note pitch over time.

1. Use the **PAGE** buttons to view the 3/3 display.

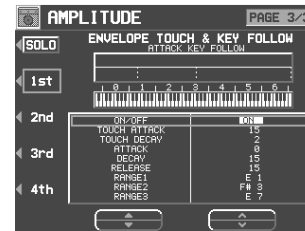

2. Use the buttons to the left of the display to select a tone.
 - Use the ▲ and ▼ buttons to select a setting item and then the ^ and v buttons to specify a selection.
3. Change the touch settings.
 - Use the TOUCH ATTACK ^ and v buttons to specify the ATTACK time change depending on touch. Use the TOUCH DECAY ^ and v buttons to specify the DECAY time change depending on touch.
 - At a – setting, the softer the keys are pressed, the greater the change. At a + setting, the harder the keys are pressed, the greater the change.
4. Change the key follow settings for the ATTACK, DECAY and RELEASE.
 - Use the RANGE buttons to specify the keyboard range.

LFO Edit

LFO can be applied to the pitch, amplitude, filter and/or pan to produce a cyclic modulation of the sound.

- Twelve LFO groups can be used.

LFO

1. On the SOUND EDIT MENU display, select LFO.
 - The display looks similar to the following.



2. Use the **PAGE** buttons to select the respective characteristics.
 - PAGE 1/4: PITCH (vibrato effect)
 - PAGE 2/4: AMPLITUDE (tremolo effect)
 - PAGE 3/4: FILTER (wah-wah effect)
 - PAGE 4/4: PANNING (auto pan effect)
3. Use the buttons to the left of the display to select a tone.
4. Adjust the respective assigned LFO's.
 - LFO which share the same number on other displays are also changed with this adjustment.

SELECT

Select the assigned LFO number (1 to 12)

SPEED

Adjust the modulation speed.

KEYSYNC

When playing more than one note, specify whether the LFO starts or not each time a key is pressed (ON/OFF).

- When KEYSYNC is set to ON: if, while playing one note, you play a second note, the LFO is applied to the second note as well.

PHASE

Degree of phase change.

5. Use the CONNECTION buttons to specify whether or not the LFO is applied to the tone.
 - An arrow mark indicates that the LFO is applied.

6. Use the TONE SETTINGS \wedge and \vee buttons to adjust the respective parameters.

PHASE

Phase

- A + indicates normal phase, and a – indicates an inverted phase.

WAVE

Modulate the waveform.

- SINE: Sine wave
- TRIANGLE: Triangle wave
- SQUARE: Square wave
- SAW TOOTH: Saw tooth wave
- RANDOM: Irregular pattern

DELAY

Delay time is the time elapsed from when the keyboard key is pressed until the modulation begins.

DEPTH

Modulation depth

TOUCH

Degree of modulation change in relation to touch

7. Repeat steps 2 to 6 for the other tones, as desired.

- You can press the OVERVIEW button to confirm the status of each LFO setting.

Effect Edit

These are settings related to the various effects applied to your edited sound.

EFFECT

1. On the SOUND EDIT menu display, select EFFECT.
- The display looks similar to the following.

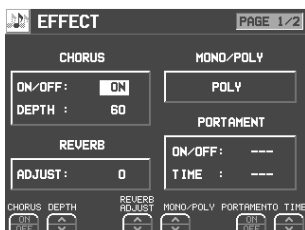

2. Use the CHORUS ON/OFF buttons set CHORUS to on or off. Use the respective DEPTH \wedge and \vee buttons to specify how the **CHORUS** is applied.
3. Use the REVERB ADJUST \wedge and \vee buttons to specify how the **REVERB** is applied.
4. Use the MONO/POLY \wedge and \vee buttons to select the sound output mode.
5. Use the PORTAMENTO ON/OFF buttons set portamento to on or off. Use the TIME \wedge and \vee buttons to set the portamento time.

DIGITAL EFFECT

1. Use the **PAGE** buttons to view the 2/2 display.
 - The display looks similar to the following.
 - The display for the effect type which is best-suited for the sound currently being edited is selected.

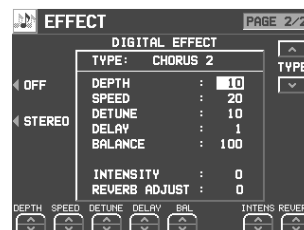

2. Use the TYPE \wedge and \vee buttons to select the type of effect.

<ON/OFF button>

Specify whether the **DIGITAL EFFECT** button turns on or off when the sound is selected. When set to ON, the **DIGITAL EFFECT** button turns on automatically when the sound is selected.

<STEREO/MONO button>

Select stereo (STEREO) or monaural (MONO) output of the effect.

3. Use the buttons along the bottom of the display to select the attribute you wish to adjust.

- When the type is changed, the parameters revert to the factory defaults.

Controller Edit

Specify how operation of the controllers, such as the wheels, etc., affects the sound.

CONTROLLER

1. On the SOUND EDIT menu display, select CONTROLLER.
 - The display looks similar to the following.

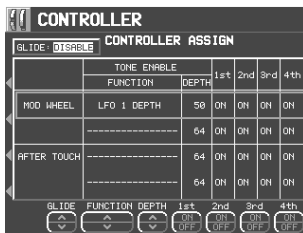

2. Use the buttons to the left of the display to select a controller.
 - Two functions can be assigned to each controller.
3. Use the FUNCTION \wedge and \vee buttons to select a function for the controller.
4. Use the DEPTH \wedge and \vee buttons to set the depth of the function applied by the controller.

5. Use the ON/OFF \wedge and \vee buttons to set the controller to on or off for each tone.
 - When set to INV, the effect is applied inversely.

6. Repeat steps 2 to 5 for the other controllers, as desired.

7. Use the GLIDE \wedge and \vee buttons to select whether or not the glide effect is active.

ENABLE:
The glide effect is enabled.

DISABLE:
The glide effect is disabled.

- To assigning a function to the foot switch, refer to page 172.

Store the new sound

The **MEMORY** button in the **SOUND GROUP** section accesses memory banks reserved for the sounds you create with the SOUND EDIT. You can store up to 40 original sounds then select the sounds just like the other sounds in the **SOUND GROUP**.

Procedure

1. When you have edited the sound to just the way you like it, on the SOUND EDIT menu display press the WRITE button.
 - The display changes to the MEMORY WRITE display.



2. To assign a name to your new sound, press the SOUND NAMING button.
 - If you do not assign a name to your sound, the name becomes the same as the original sound from which you started. In this case, skip to step 5.
 - The display changes to the SOUND NAMING display.



3. Use the buttons below the display to assign a name.
 - Set the character input position with the POSITION buttons, select the characters with the alphanumeric buttons and repeat name assignment.
 - Switch from upper to lower case letters with the ABC, abc button.
 - Press the INS button to enter a space at the cursor position.
 - Press the DEL button to erase the character at the cursor position.
 - Press the CLR button to erase the entire name.
 - Press the →← button to center the name.
4. When you have finished typing the name, press the OK button.
 - The display returns to the MEMORY WRITE display.
5. Use the ^ and v buttons to select the MEMORY number in which to store the new sound (1–40).
6. Press the OK button.
 - The new sound is stored, and “COMPLETED!” is shown on the display.
 - The SOUND EDIT mode is turned off.
 - The stored sound memories can be saved on a disk/an SD card for recall at a later time. (Refer to pages 125, 140.)

Select a new sound

You can select your original sound just like the other sounds in the **SOUND GROUP**.

1. In the **SOUND GROUP** section, press the **MEMORY** button.



- The list of sounds is shown on the display.
2. Select the desired sound from the list on the display.

Part XI Control

Outline of Control functions

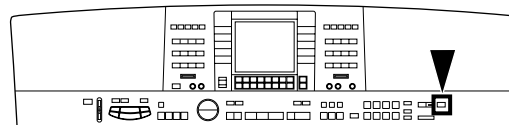

Various settings related to the operation of this instrument are adjusted with the CONTROL functions.

1. Press the **PROGRAM MENUS** button to turn it on.

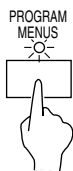

- The display looks similar to the following.

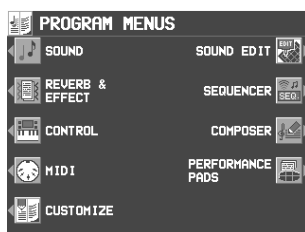

2. Select CONTROL.

- The display looks similar to the following.

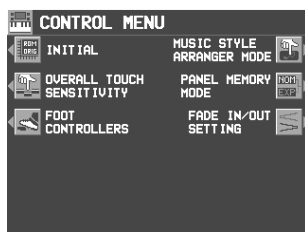

3. Select a function.

INITIAL

Return the settings and memories to the factory-preset status. (Refer to page 186.)

OVERALL TOUCH SENSITIVITY (page 172)

Adjust the amount of keyboard touch response.

FOOT CONTROLLERS (page 172)

Assign functions to the separately sold Foot Switch and Foot Controller, etc.

PANEL MEMORY MODE

Define which panel settings are stored when the **PANEL MEMORY** is used. (Refer to page 66.)

MUSIC STYLE ARRANGER MODE

Define which panel settings change by pressing a **FILL IN** button when the **MUSIC STYLE ARRANGER** is used. (Refer to page 63.)

FADE IN/OUT SETTING

Settings related to the **FADE IN/FADE OUT**. (Refer to page 58.)

4. Follow the procedure to adjust the settings.

- While you are adjusting the settings, when the **TEMPO/PROGRAM** indicator is lit, it indicates that the **TEMPO/PROGRAM** is available for setting the current function.

5. When you have finished setting the functions, press the **PROGRAM MENUS** button to turn it off.

Overall Touch Sensitivity

This instrument features INITIAL TOUCH (the volume, for example, changes depending on how hard the keyboard is played).

1. On the CONTROL MENU display, select OVERALL TOUCH SENSITIVITY.
 - The display looks similar to the following.

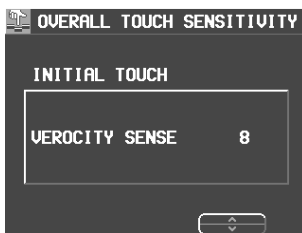

2. Use the \wedge and \vee buttons to adjust the amount of keyboard touch response (0 to 9).
 - When set to 0, initial touch sensitivity is turned off.

Foot Controllers

If an optional Foot Switch and/or Expression Pedal (sold separately) is connected, you can assign it one of several functions, allowing convenient and fast control during your performance.

1. On the CONTROL MENU display, select FOOT CONTROLLERS.
 - The display looks similar to the following.



2. Use the CONTROLLER \blacktriangle and \blacktriangledown buttons to select a switch name, and the FUNCTION \wedge and \vee buttons to select its function.

■ FOOT SWITCH

OFF:

No function is assigned.

SOFT PEDAL:

Soft on/off

SOSTENUTO PEDAL:

Sostenuto on/off

P. MEM INCREMENT:

Increment the **PANEL MEMORY** number selection by 1.

P. MEM DECREMENT:

Decrement the **PANEL MEMORY** number selection by 1.

P. MEM BANK INC.:

Change to the next **PANEL MEMORY** bank in order.

P. MEM BANK DEC.:

Change to the previous **PANEL MEMORY** bank in order.

PANEL MEMORY 1 to 8:

The specified **PANEL MEMORY** number is turned on.

P. MEM INC.+DEC.:

Press the switch to increment the **PANEL MEMORY** number selection by one; release the switch to return to the previous number.

START/STOP:

START/STOP button on/off

FILL IN 1:

FILL IN 1 button on

FILL IN 2:

FILL IN 2 button on

INTRO & ENDING 1:

INTRO & ENDING 1 button on

INTRO & ENDING 2:

INTRO & ENDING 2 button on

SUSTAIN:

SUSTAIN button on/off

GLIDE:

Glide on/off (The glide effect “bends” the pitch down by about one semitone.)

TECHNI-CHORD:

TECHNI-CHORD button on/off

DIGITAL EFFECT:

DIGITAL EFFECT button on/off

MULTI EFFECT:

MULTI EFFECT button on/off

ROTARY SLOW/FAST:

TREMOLO SLOW/FAST of the **DIGITAL DRAWBAR**

MIC REVERB:

MIC REVERB button on

MIC EFFECT:

MIC EFFECT button on

PUNCH RECORD:

Punch in/punch out

APC HOLD:

Memorize the chord specified for the automatic accompaniment.

FADE IN:

FADE IN button on/off

FADE OUT:

FADE OUT button on/off

PAD 1 to 6:

Specified **PERFORMANCE PADS** on

TAP TEMPO:

TAP TEMPO button on.

■ EXPRESS. PEDAL

TOTAL EXPRESSION:

The volume for all parts changes when the expression pedal is operated.

PART EXPRESSION:

The volume changes only for parts for which PART EXP PEDAL was turned ON on the PART SETTING display for SOUND. (Refer to page 148.)

- The initialized settings are as follows:

FOOT SWITCH	SUSTAIN
EXPRESS. PEDAL	TOTAL EXPRESSION

- For connection of a Foot Switch, etc., refer to page 188.

Part XII Customize

Outline of Customize functions

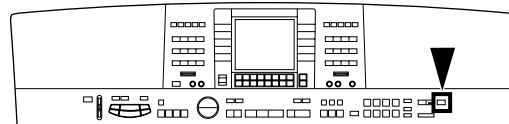

Many of this instrument's settings can be customized for maximum playing convenience and ease.

1. Press the **PROGRAM MENUS** button to turn it on.
 - The display looks similar to the following.

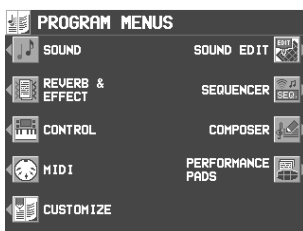

2. Select **CUSTOMIZE**.
 - The display looks similar to the following.



(KN2400)

3. Select a function.

FAVORITES SETTING

FAVORITES display settings (page 33)

DISPLAY TIME OUT (page 175)

Adjust settings related to the screen display.

DATA PROTECTION (page 176)

Specify when you don't want the data to change in cases where it normally does, for instance during disk load and when automatic settings are made, etc.

MIDI SETTING LOAD OPTION (page 176)

Specify how MIDI data is handled when data is loaded from a disk.

LANGUAGE SETTING

Select your preferred language for the displayed messages.

- The display is different, but the operation is the same as for **HELP** (page 33).

DISK PREFERENCES (KN2400)

Automatic display when a floppy disk is inserted (page 130).

SD PREFERENCES (KN2600)

Specify the desired priority of displays when the **LOAD** button is pressed on the control panel (page 145).

4. Follow the procedure to adjust the settings.

- While you are adjusting the settings, when the **TEMPO/PROGRAM** indicator is lit, it indicates that the **TEMPO/PROGRAM** is available for setting the current function.

5. When you have finished setting the functions, press the **PROGRAM MENUS** button to turn it off.

Display Time Out

Numerous message displays and setting displays conveniently guide you through the operation steps of this instrument. Once you become familiar with the operation of your instrument, however, you may wish to shorten or even suspend the display time of the message displays.

1. On the CUSTOMIZE display, select DISPLAY TIME OUT.

- The display looks similar to the following.

DISPLAY TYPE	TIME
SAVE REMINDER	HOLD
'COMPLETED' MESSAGE	2 sec
ARE YOU SURE?	DEFAULT
ERROR MESSAGE	1 sec
SOUND/RHYTHM SELECT	HOLD
EASY SETTING	DEFAULT

2. Use the DISPLAY TYPE \wedge and \vee buttons to select the function.

SAVE REMINDER:

Reminder display (OFF, DEFAULT, HOLD, 1 to 10 sec)

'COMPLETED' MESSAGE:

Operation successfully completed (OFF, DEFAULT, HOLD, 1 to 10 sec)

ARE YOU SURE?:

Display requires user action for confirmation (OFF, DEFAULT, HOLD)

ERROR MESSAGE:

Error notification display (DEFAULT, HOLD, 1 to 10 sec)

SOUND/RHYTHM SELECT:

Sound/rhythm and **PERFORMANCE PADS BANK** selection display (DEFAULT, HOLD, 1 to 10 sec)

EASY SETTING:

Display time when the setting display was accessed pressing and holding a panel button (DEFAULT, HOLD, 1 to 10 sec)

- When set the OFF, the display will not appear.
- When set to DEFAULT, the display time returns to the initialized setting.
- You can specify 1 to 10 seconds for the display time.
- When set to HOLD, the **DISPLAY HOLD** automatically turns on.

3. Use the TIME \wedge and \vee buttons to change the setting.

4. Press the OK button.

- Some messages may be displayed even if they are set to OFF.

Data Protection

Data which you don't want to change but which is normally overwritten during disk load, song change, or the automatic setting functions, etc. can be protected from accidental overwriting.

1. In the CUSTOMIZE MENU display, select DATA PROTECTION.
 - The display looks similar to the following.

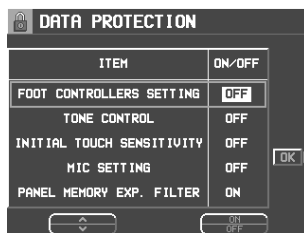

2. Use the ITEM ^ and v buttons to select an item.

3. Use the ON/OFF button to select ON or OFF.

ON:
The data is protected and will not be changed.

OFF:
The data is not retained.

4. Repeat steps 2 and 3 for each item.

5. Press the OK button.

MIDI Setting Load Option

Specify how MIDI data is handled when data is loaded from a disk.

1. On the CUSTOMIZE MENU display, select MIDI SETTING LOAD OPTION.
 - The display looks similar to the following.

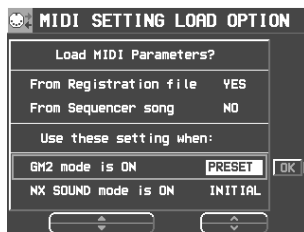

2. Use the ▲ and ▼ buttons to select an item.

■ Load MIDI Parameters?

From Registration file:

Specify whether MIDI data is also loaded when panel data is loaded (NO/YES).

From Sequencer Song:

Specify whether MIDI data is loaded or changed when **SEQUENCER** data is loaded or when the SONG is changed by the **SEQUENCER SONG SELECT**, **SONG COPY** or **TRACK ASSIGN** (NO/YES).

- The MIDI settings are always stored at the start of each recorded **SEQUENCER SONG** and when **PANEL WRITE** is executed. In the initialized state, the MIDI settings are not loaded even when the SONG is changed. However, changing this setting to YES will cause the stored MIDI settings to also load in these cases.

■ Use these settings when:

GM2 mode ON:

Specify how the MIDI settings of this instrument are affected when GM2 is on.

- Select from INITIAL, (initialized settings), PRESET (MIDI PRESETS), and KEEP (the settings do not change).

NX SOUND mode ON:

Specify how the MIDI settings of this instrument are affected when NX SOUND is ON.

- Select from INITIAL, (initialized settings), PRESET (MIDI PRESETS), and KEEP (the settings do not change).

3. Use the ^ and v buttons to change the setting.

4. Press the OK button.

Part XIII MIDI

What is MIDI?

MIDI (Musical Instrument Digital Interface) is the international standard for digital communication of electronic musical instrument data. This means that any equipment which has a MIDI terminal—such as electronic musical instruments and personal computers—can easily exchange digital data with other MIDI equipment without resorting to complicated conversions or connections.

MIDI terminals

(On the rear panel)

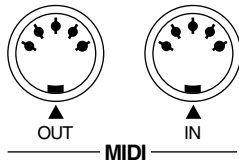

IN:

The terminal by which this instrument receives data from other equipment.

OUT:

The terminal that transmits data from this instrument to other equipment.

- For these connections, use a commercially available MIDI cable.

Connection examples

- To generate sound from a connected instrument by playing this instrument

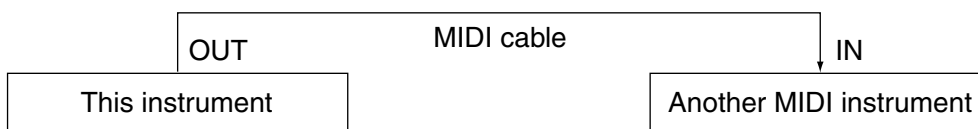

- To generate sound from this instrument by operating a connected instrument

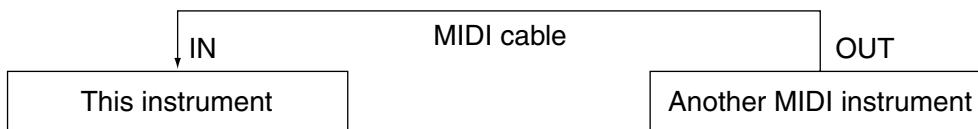

- To connect with a MIDI sequencer

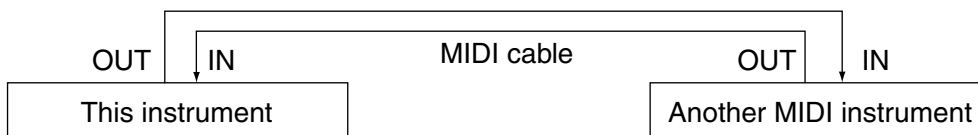

MIDI channels

Many different kinds of performance data are sent using just one MIDI cable. This is possible because MIDI signals are sent and received through 16 different “basic channels” (numbered 1 to 16). In order for the exchange of data to take place, the channels on the transmission side must match the channels on the receiving side. This characteristic also makes it possible to link multiple sound generators and to control each by matching specific channels.

The following kinds of data can be transmitted/received.

■ NOTE data

This is the most basic kind of MIDI data which is exchanged, and is used to specify which keys are played and how hard they are played.

NOTE NUMBER: Number specifying which key is played.

NOTE ON: Specifies that a key is played.

NOTE OFF: Specifies that a key is released.

VELOCITY: Specifies how hard a key is struck.

- MIDI notes are assigned numbers from 0 to 127, with middle C (C3) as 60. Note pitches are in semitone increments, with the higher numbers assigned to the higher pitches.

■ PROGRAM CHANGE

This is sound change data. When a different sound is selected on the transmitting instrument, the sound on the receiving instrument also changes.

■ CONTROL CHANGE

These are volume, sustain, effect, etc. data used to enhance performance expression. Each function is distinguished by its control number, and the function which can be changed by the control differs depending on the instrument.

■ EXCLUSIVE data

This is data that is specific to this instrument, and data for the GENERAL MIDI LEVEL 2 mode setting.

Outline of MIDI functions

1. Press the **PROGRAM MENUS** button to turn it on.

- The display looks similar to the following.

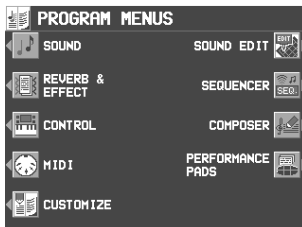

2. Select MIDI.

- The display looks similar to the following.

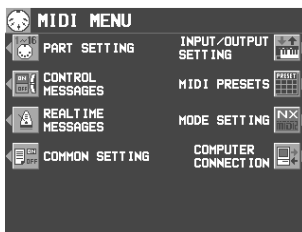

Summary of the MIDI menu items

PART SETTING (page 180)

Set the MIDI CHANNEL, OCTAVE and LOCAL CONTROL settings for each part.

CONTROL MESSAGES (page 181)

Enable or disable the exchange of various CONTROL data.

REALTIME MESSAGES (page 181)

Enable or disable the exchange of REALTIME COMMANDS, and select the CLOCK mode.

COMMON SETTING (page 182)

Set the functions which are common to all parts.

INPUT/OUTPUT SETTING (page 183)

Settings which determine how various performance data is treated during data transmission and reception.

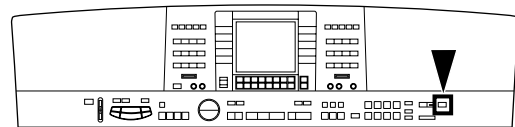

3. Select a function.

4. Follow the procedure to adjust the settings.

- While you are adjusting the settings, when the **TEMPO/PROGRAM** indicator is lit, it indicates that the **TEMPO/PROGRAM** is available for setting the current function.

5. When you have finished setting the functions, press the **PROGRAM MENUS** button to turn it off.

Part Setting

Follow this procedure to set the functions which can be set for each part: MIDI CHANNELs, the OCTAVE data to NOTE data during transmission, and LOCAL CONTROL (whether or not the sound generator of this instrument is active during transmission).

1. On the MIDI MENU display, select PART SETTING.
 - The display looks similar to the following.

PART	CHANNEL	OCTAVE	LOCAL
RIGHT1	1	0	ON
RIGHT2	2	0	ON
LEFT	3	0	ON
CONTROL	OFF	---	---
CHORD	OFF	0	ON

2. Use the PART ▲ and ▼ buttons to select a part.
 - The list of parts covers 4 pages. Use the **OTHER PARTS/TR** button or **PAGE** button to view different parts.
3. Use the CHANNEL ^ and v buttons to select a MIDI CHANNEL for the part (OFF, 1 to 16).
 - A part which has been set to OFF cannot be used to transmit or receive MIDI data.
 - The initialized settings are as follows:

RIGHT 1	1
RIGHT 2	2
LEFT	3
PART 1	OFF
PART 2	OFF
PART 3	OFF
PART 4	4
PART 5	5
PART 6	6
PART 7	7
PART 8	8
PART 9	9
PART 10	10
PART 11	11
PART 12	12
PART 13	13
PART 14	14
PART 15	15
PART 16	16
CONTROL	OFF
ACCOMP 1 – 5	OFF
BASS	OFF
DRUMS 1 – 2	OFF
CHORD	OFF

4. Use the OCTAVE ^ and v buttons to set the octave shift value (–3 to 3).
 - Octave shift is set for transmitted data only; however the transmitted and received octave shifts are linked. For example, if the transmitted octave shift is set to 1, the received octave shift is automatically set to –1.
5. Use the LOCAL ^ and v buttons to enable or disable this instrument's sound generator.
 - When set to ON, the performance from this instrument is transmitted as MIDI data and also sounds from this instrument. When set to OFF, the performance from this instrument is transmitted as MIDI data but does not sound from this instrument.
6. Repeat steps 2 to 5 for each part as desired.

Control Messages

Enable or disable the exchange of various control data.

1. On the MIDI MENU display, select CONTROL MESSAGES.
 - The display looks similar to the following.
 - The CONTROL MESSAGES display consists of 3 pages. Use the **PAGE** buttons to switch between pages.

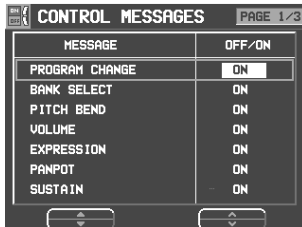

2. Use the MESSAGE ▲ and ▼ buttons to select the control message.

3. Use the ON and OFF ^ and v buttons to specify on or off for the control message.

ON:

Data for the control operation is exchanged.

OFF:

Data for the control operation is not exchanged.

- The BANK SELECT setting is effective only when PRG. CHANGE is set to ON.
- The EFFECT & REVERB setting controls the **DIGITAL EFFECT**, **CHORUS**, **MULTI** and **REVERB** on/off.
- RPN is the general term for KEY SHIFT, TUNING, PITCH BEND RANGE and MODULATION SENSITIVITY.

4. Repeat steps 2 and 3 for each control as desired.

Realtime Messages

Enable or disable the exchange of **START/STOP** data (REALTIME COMMANDS), and select the CLOCK mode.

1. On the MIDI MENU display, select REALTIME MESSAGES.
 - The display looks similar to the following.



2. Use the buttons on the left side of the display to select a function.
3. Use the VALUE ^ and v buttons to change the setting.

REALTIME COMMANDS

ON:

Rhythm and **SEQUENCER** start/stop, continue, and song position pointer data can be transmitted/received.

OFF:

This data cannot be transmitted/received.

CLOCK

INTERNAL:

This instrument's internal clock is used to control the performance. The clock of the connected equipment is disabled.

MIDI:

The clock of the connected equipment is used to control the performance. This instrument's clock is disabled. (The tempo is displayed as "♩ = ---.")

- The CLOCK is set to INTERNAL when the power to this instrument is turned on.

4. Repeat steps 2 and 3 for the other function if desired.

Common Setting

Set the functions which are common to all parts.

1. On the MIDI MENU display, select COMMON SETTING.
 - The display looks similar to the following.

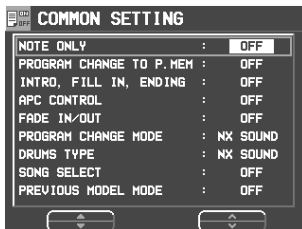

2. Use ▲ and ▼ buttons to select the item.

NOTE ONLY:

Of the performance data, specify whether or not only note data is exchanged.

PROGRAM CHANGE TO P. MEM:

Enable or disable the exchange of program change numbers for the **RIGHT 1** part by operation of the **PANEL MEMORY** buttons.

- For this setting, the **PANEL MEMORY 1** to **8** program change numbers correspond to the bank numbers as follows:
BANK A = 0 to 7
BANK B = 8 to 15 ...

INTRO, FILL-IN, ENDING:

Enable or disable the exchange of intro, fill-in and ending data.

APC CONTROL:

Enable the exchange of data for the on/off status of the **AUTO PLAY CHORD**'s BASIC, ADVANCED and PIANIST modes.

FADE IN/OUT:

Specify whether or not FADE IN/OUT data is exchanged.

PROGRAM CHANGE MODE

NX SOUND:

Program change numbers are standardized among NX SOUND Technics models which are set to this mode. The program change number assigned to a given sound on one model is assigned to the same sound on all models which are set to the same mode.

PREVIOUS TECH:

Program change numbers are standardized among non-NX SOUND Technics models which are set to this mode. The program change number assigned to a given sound on one model is assigned to the same sound on all models which are set to the same mode.

MAP R:

GS basic sounds are transmitted and received as GS program change numbers.

MAP Y:

XG basic sounds are transmitted and received as XG program change numbers.

*GS is a trademark of Roland Corporation. XG is a trademark of Yamaha Corporation.

DRUMS TYPE

NX SOUND:

Keyboard percussion instrument sounds correspond to the same key note numbers for connected NX SOUND Technics models that are set to this type.

PREVIOUS TECH:

Keyboard percussion instrument sounds correspond to the same key note numbers for connected non-NX SOUND Technics models that are set to this type.

SONG SELECT

ON:

Song number data can be exchanged.

OFF:

Song number data cannot be exchanged.

PREVIOUS MODEL MODE

ON:

INTRO, FILL IN, ENDING and APC CONTROL, FADE IN/OUT data are converted to CONTROL CHANGE data for previous models * and then transmitted.

OFF:

The above settings are not converted.

- * "Previous models" include all Technics instrument models except for:
 KN7000/6500/6000
 PR604/804/603/703/903/1000

3. Use ^ and v buttons to change the setting.

4. Repeat steps 2 and 3 for the other settings as desired.

Mode Setting

Initialize the settings for when the NX SOUND or GM LEVEL 2 mode is ON.

1. On the MIDI MENU display, select MODE SETTING.

- The display looks similar to the following.

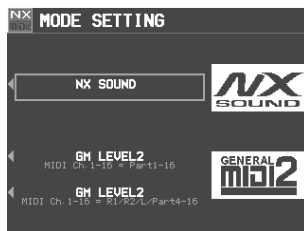

2. Select the mode.

- There are two modes for GM LEVEL 2 depending on the parts to use.
- The confirmation display appears. Press the YES button to execute the function, or press the NO button to cancel the function.

Input/output Setting

Make the settings which determine how various performance data is treated during data transmission and reception.

1. On the MIDI MENU display, select INPUT/OUTPUT SETTING.

- The display looks similar to the following.

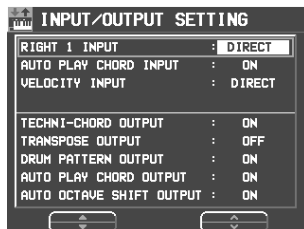

2. Use the ▲ and ▼ buttons to select the item.

RIGHT 1 INPUT

CONDUCTOR:

When data for the **RIGHT 1** part is received, the **CONDUCTOR** determines which part it is used for.

DIRECT:

When data for the **RIGHT 1** part is received, it is treated as **RIGHT 1** data, and performance data for all parts is received on their respective basic channels.

AUTO PLAY CHORD INPUT

ON: Input data for the **ACCOMP**, **BASS**, **APC** and **CHORD** parts is received.

OFF: Data for the above parts is not received.

- MIDI channels should be assigned to the above parts before exchanging data.

VELOCITY INPUT

DIRECT:

The **VELOCITY** value of received **NOTE ON** data is treated as is.

OFFSET:

The **VELOCITY** value of received **NOTE ON** data is offset (–50 to 50).

- Select **VELOCITY OFFSET VALUE**. Use the ▲ and ▼ buttons to change the value.
- All the values are offset from the current value by the fixed amount.
- The upper (127) and lower (1) limits cannot be exceeded.

FIX:

The **VELOCITY** value of all received **NOTE ON** data is set to a fixed value. (1 to 127)

- Select **VELOCITY FIXED VALUE**. Use the ▲ and ▼ buttons to change the value.

TECHNI-CHORD OUTPUT

ON: Keyboard notes generated by the **TECHNI-CHORD** function are also transmitted.

OFF: Only key note data of the pressed keys is transmitted.

TRANSPOSE OUTPUT

ON: The note data of the transposed notes is transmitted.

OFF: The note data of the played keys is transmitted.

DRUM PATTERN OUTPUT

- ON: Data from the **DRUMS** part is transmitted.
- OFF: Data from the **DRUMS** part is not transmitted.

AUTO PLAY CHORD OUTPUT

- ON: The data for the **ACCOMP** and **BASS** parts is transmitted.
- OFF: The data for the above parts is not transmitted.
- MIDI channels should be assigned to the above parts before exchanging data.

AUTO OCTAVE SHIFT OUTPUT

- ON: If the octave has been automatically changed, the data of the transposed notes is transmitted, depending on the sound.
- OFF: The note data of the played keys is transmitted.

3. Use the \wedge and \vee buttons to select the setting.

4. Repeat steps 2 and 3 for each item as desired.

MIDI Presets

Establish the optimum settings depending on how this Keyboard is connected to other equipment, and on whether this Keyboard is used as the master or the slave.

- On the MIDI MENU display, select MIDI PRESETS.
 - The display looks similar to the following.

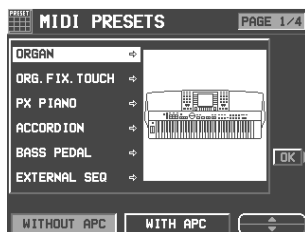

- Use the \blacktriangle and \blacktriangledown buttons to select the connection setup.
 - The PAGE 1/4 display shows connection setups with this instrument as the SLAVE. And the PAGE 2/4 display shows connection setups with this instrument as the MASTER.
 - The MASTER is the instrument used to transmit data, and the SLAVE is the instrument used to receive the data.
 - Use the buttons below the display to select WITHOUT APC (the **AUTO PLAY CHORD** is not used) or WITH APC (the performance includes **AUTO PLAY CHORD**).

3. Press the OK button.

- When the settings have been successfully stored, "COMPLETED!" appears on the display.

Notice

When an instrument such as an organ or accordion with separate or divided keyboards dedicated to melody and chords is used as the master instrument, if this instrument's split point is set to a note below the lowest note of the melody keyboard of the master instrument, it is possible to produce melody notes on multiple parts by this instrument's **CONDUCTOR** settings.

- Assign the RIGHT 1 channel as the CHANNEL for the melody keyboard. Assign the CHORD channel (or if you also wish the played note to be produced, CHORD + LEFT) as the CHANNEL for the chord keyboard.
- You will also have to specify CONDUCTOR as the RIGHT 1 INPUT for the INPUT/OUTPUT SETTING.

■ Storing user settings

After you change the MIDI settings, you can store your customized settings in USER.

1. Adjust the various MIDI settings.
2. Go to PAGE 4/4 of the MIDI PRESETS display.
 - The display looks similar to the following.



3. Use the WITH SPLIT POINT? button to specify whether or not to also store the keyboard split point (YES/NO).
4. Press the WRITE button.

■ Recalling the USER settings

1. Go to PAGE 3/4 of the MIDI PRESETS display.



2. Press the OK button.

Computer Connection

These settings are used to select the mode related to MIDI signal flow when a personal computer is connected to the **USB** terminal of this instrument.

- When connecting to a personal computer, install the USB driver on the included CD-ROM to the computer first. (Refer to the separate manual for more information.)

1. Turn off the power to this instrument.
2. Connect a personal computer to the **USB** terminal on the rear of this instrument.
3. Turn on the power to this instrument.
4. On the MIDI MENU display, select COMPUTER CONNECTION.
 - The display looks similar to the following.

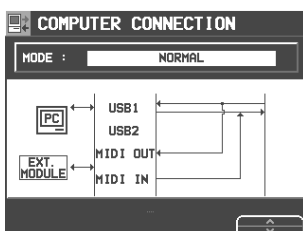

5. Use the ^ and v buttons to select a mode.

NORMAL:

Ordinary mode

PC as master:

The mode which is appropriate for data transmission

KN as master:

The mode when this instrument is used as the master keyboard.

KN as slave:

The mode when this instrument is used as a slave instrument.

INTERFACE:

The mode when this instrument is used as a connecting device between a PC with only USB terminals and an instrument with only MIDI terminals.

Initialize

This Keyboard has many settable functions and storable memories. However, you can return the settings and memory to the factory-preset status.

INITIAL

1. Press the **PROGRAM MENUS** button to turn it on.

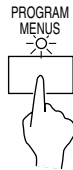

- The display changes to the following.

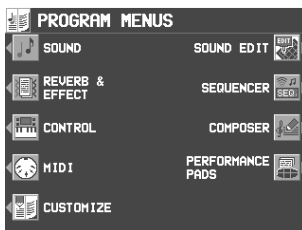

2. Select **CONTROL**.

- The display looks similar to the following.

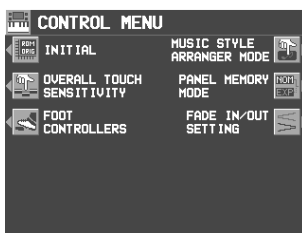

3. Select **INITIAL**.

- This display changes to the following.



4. Use the **▲** and **▼** buttons to select the desired type of initialization.

- **PERFORMANCE** includes all the items which are listed below it.

5. Press the **OK** button.

- The display changes to the confirmation display. Press the **YES** button if you wish to execute the initialization. Press the **NO** button if you wish to cancel the procedure.



- Initialization begins. When initialization is completed, "COMPLETED!" is shown on the display and the Keyboard returns to the normal performance mode.
- The **USER MIDI** and **FAVORITES** are not initialized by this procedure.

You can also reset all the **PERFORMANCE** items with the following procedure:
 Turn off the power to this instrument once. Then, while pressing the three lower left buttons in the **RHYTHM GROUP** section (**JAZZ & SWING**, **BALLROOM & SHOW** and **LATIN & WORLD**) at the same time, turn the power on again.

About the performance data

PERFOR- MANCE	CURRENT PANEL settings
	PANEL MEMORY
	SEQUENCER
	COMPOSER (MEMORY contents)
	PERFORMANCE PADS (USER memories)
	SOUND MEMORY
	EFFECT MEMORY
BACKUP	MIDI (USER for the MIDI PRESETS) & FAVORITES

- The BACK UP data will not be erased even with the passage of time.
- The backup memory does not function for the stored contents until the power has been on for about 10 minutes.
- If you wish to retain the settings and stored memory contents for recall at a later time, store the desired data on a disk/SD card.
- Data from previous Technics models may be limited to PERFORMANCE data.

Separately sold options

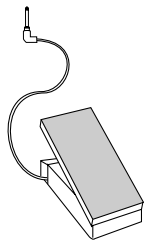

SZ-E2
Expression Pedal

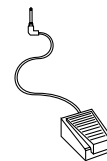

SZ-P1
Foot Switch

PLUG-IN feature

This model is compatible with third-party extension plug-in software for the **KN2400/KN2600**. See plug-in documentation for information about software features and operation.

Terminals

Back panel terminals

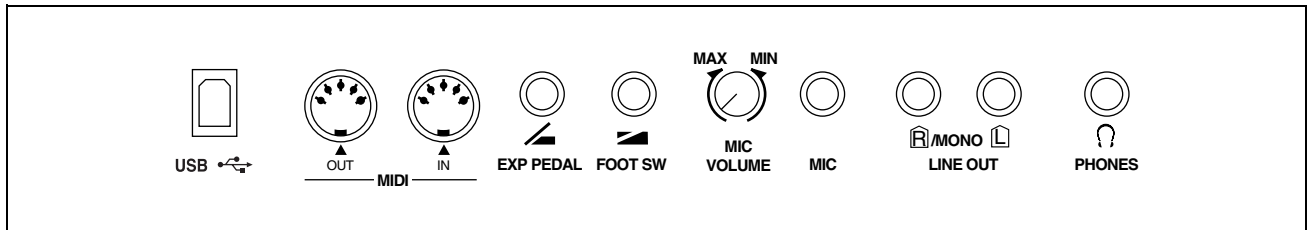

USB

This terminal allows connection to a personal computer with a USB cable (commercially available type AB cable).

Used with the applications on the included CD-ROM, you can record this instrument's audio sound or manage the instrument data with your PC.

- **Applications**

- **Audio Recorder:**

- Application for Recording this instrument's sounds and for saving recorded digital audio files in WAV, WMA (Windows Audio Format) and MP3 formats.

- **Song Manager:**

- Application for managing this instrument's data on your PC by means of a USB cable.

MIDI

These terminals are for connection to another MIDI instrument. (Refer to page 177.)

EXP PEDAL

The optional SZ-E2 Expression Pedal (sold separately) can be connected to this terminal to control the volume.

FOOT SW

An optional SZ-P1 Foot Switch (sold separately) can be connected to each terminal to control various functions. (Refer to page 172.)

MIC

A microphone can be connected to this terminal. (Refer to page 44.)

- Adjust the volume using **MIC VOLUME**.

LINE OUT

The total sound of this instrument can be output from this terminal.

- For monaural output, connect the plug only in the **R/MONO** terminal.

PHONES

Headphones can be connected to this instrument.

- When headphones are plugged into this jack, the speakers of this instrument are disabled.

Symptoms which appear to be signs of trouble

The following changes in performance may occur in the Technics Keyboard but do not indicate trouble.

	Phenomenon	Remedy
Sounds and effects	The buttons, keys, etc. malfunction.	<ul style="list-style-type: none"> • Turn off the POWER button once, then turn it on again. If this procedure is not successful, turn off the POWER button once. Then, while pressing the three lower left buttons in the RHYTHM GROUP section (JAZZ & SWING, BALLROOM & SHOW and LATIN & WORLD) at the same time, turn the POWER button on again. (Note that, in this case, all programmable settings, functions and memories return to their factory-preset status.)
	No sound is produced when the keys are pressed.	<ul style="list-style-type: none"> • The MAIN VOLUME is at the minimum setting. Adjust the volume with the MAIN VOLUME control. • The volumes for the selected parts are set to the minimum levels. Use the balance buttons to set the volumes of the relevant parts to appropriate levels. (Refer to page 29.) • The part is muted. (Refer to page 30.) • The LOCAL CONTROL for a part performed on the keyboard is set to OFF. Set the LOCAL CONTROL to ON. (Refer to page 180.)
	Only percussive instrument sounds are produced when the keyboard is played.	<ul style="list-style-type: none"> • In the SOUND GROUP section, the DRUM KITS button is on.
	The volume is very low when the keyboard is played.	<ul style="list-style-type: none"> • The volume setting in the SEQUENCER contents is very low. Follow the INITIAL procedure to reset the settings. (Refer to page 186.)
	The sound you hear is different from the sound you selected.	<ul style="list-style-type: none"> • This sometimes occurs when you play back SEQUENCER or COMPOSER data which was created on a different model, or when MIDI data is received from a connected instrument. Select the desired sounds again.
Rhythm	The rhythm does not start.	<ul style="list-style-type: none"> • The DRUMS volume is set to the minimum level. Use the balance buttons to set the DRUMS volume to an appropriate level. • A SEQUENCER PLAY button is on. When you are not playing back the SEQUENCER performance, turn off the SEQUENCER PLAY button. • CLOCK is set to MIDI. Set CLOCK to INTERNAL. (Refer to page 181.)
AUTO PLAY CHORD	No sound is produced for the automatic accompaniment, or only the sounds of some parts are produced.	<ul style="list-style-type: none"> • An ACCOMP part does not sound if its corresponding volume is set to the minimum level. Use the respective balance buttons to set the ACCOMP 1–5 volumes to appropriate levels.
SEQUENCER	Storage is not possible.	<ul style="list-style-type: none"> • The remaining memory capacity of the SEQUENCER is 0. Follow the SONG CLEAR or TRACK CLEAR procedure to erase the memory. (Refer to page 93.)
	The playback measure indication is different from when the performance was recorded.	<ul style="list-style-type: none"> • The number of measures corresponds to the time signature of the rhythm selected at the start of recording. To change the rhythm in the middle of the song, record the rhythm change in the RHYTHM part. (Refer to page 90.)

Phenomenon		Remedy
COMPOSER	Storage is not possible.	<ul style="list-style-type: none"> The remaining memory capacity of the COMPOSER is 0.
	Setting the time signature is not possible.	<ul style="list-style-type: none"> The time signature cannot be changed for a pattern which is currently recorded in the COMPOSER. If you wish to change the time signature, first follow the procedure to clear the memory. (Refer to page 107.)
	The playback timing of the rhythm pattern is different from the timing with which it was recorded.	<ul style="list-style-type: none"> The QUANTIZE function was on when the pattern was recorded and the timing was automatically corrected. Set the quantize level to a smaller note unit or to OFF when recording. (Refer to page 108.)
Disk/SD card	The Disk Drive produces a noise during recording or playback.	<ul style="list-style-type: none"> This occurs when the Disk Drive is reading a disk. It does not indicate a problem.
	When the procedure to load from a disk/SD card is performed, the contents of the keyboard memory are erased.	<ul style="list-style-type: none"> When performing the load operation from a disk/SD card, the keyboard memory changes to that of the data loaded from the disk. If you wish to preserve a song which is stored in the keyboard memory, save it on a disk/SD card before performing the load procedure.
MIDI	Data cannot be exchanged through MIDI terminals.	<ul style="list-style-type: none"> Match the channels on the transmitting side and the receiving side. (Refer to page 180.)
	The sound quavers or is distorted.	<ul style="list-style-type: none"> When the USB terminal or both the MIDI IN and OUT terminals are connected to a computer, depending on the computer software the received data may be sent back to the instrument just as it is. Because of this the sound generated from the keys and the sound generated from the returned data are both produced, causing undesirable effects, such as the sounds canceling each other out, for example. In this case, either change the software settings to prevent received data from being returned, or set the MIDI LOCAL CONTROL to off.
Other	Noise from a radio or TV can be heard.	<ul style="list-style-type: none"> This sometimes occurs when electrical equipment such as a radio or TV is used near the instrument. Try moving such electrical equipment further away from the instrument. The sound may be coming from a nearby broadcast station or amateur radio station. If the sound is bothersome, consult your dealer or service center.
	The cabinet becomes warm during use.	<ul style="list-style-type: none"> This instrument has a built-in power source that heats the cabinet to some degree. This is not an indication of trouble.

Error messages

No.	Contents
00	The data on the disk that you are using is for a different product.
01	An error has occurred while the disk was loading. Please try again!
02	There is no disk in the Disk Drive.
03	The file that you tried to load is empty.
05	An error has occurred while the disk was saving. Please try again!
06	The disk that you are using is write protected. Please remove the write protection and try again.
07	The disk that you are using is full. Please use another disk.
08	An error has occurred while the disk was formatting. The disk that you are using may be faulty. Please try formatting another disk.
10	The data is already copy protected.
15	The song you are trying to save is empty.
16	This STANDARD MIDI FILE is incompatible with this instrument and cannot be loaded.
17	This is not a STANDARD MIDI FILE.
18	The timebase (PPQ resolution) that you tried to load is not 24/48/96/192/288/384 PPQ.
20	A problem has occurred with your SEQUENCER Data. This might be due to a damaged or faulty disk.
21	Memory full
22	It is necessary to press REC STOP to complete this procedure.
23	It is impossible to change the time signature because it has already been set in the existing tracks.
24	A rhythm track already exists. It is impossible to assign two tracks to rhythm.
25	It is only possible to change the velocity on a melody track.
26	It is only possible to merge melody tracks. Tracks such as rhythm, chord and control cannot be merged.

No.	Contents
27	It is only possible to copy melody tracks. Tracks such as rhythm, chord and control cannot be copied.
28	This song is too long to be saved as a MIDI file.
29	The MIDI file that you have tried to load exceeds the memory capacity of this instrument and cannot be played. The SEQUENCER memory has been cleared.
30	It is not possible to change the time signature of a COMPOSER pattern after it has been recorded. If you want to proceed, you must first clear the entire COMPOSER pattern.
31	The time signature of the pattern from which you are copying is different from the COMPOSER memory that you are using. Either: Change the time signature of the COMPOSER memory or: Copy from a pattern that has the same time signature
32	Memory full
33	Select a Track before setting parameters for AUTO PUNCH RECORD.
43	The file that you are trying to load was saved on a previous KN keyboard. It is only possible to load using the "PERFORMANCE" option.
44	It is impossible to edit a Drum Kit. Please select a different sound from any group except Keyboard Percussion.
46	It is only possible to insert MELODY Tracks. Tracks such as RHYTHM, CHORD and CONTROL cannot be inserted.
47	This procedure is not possible with a composer pattern or the metronome. Please select a preset rhythm pattern.
54	It is not possible to record using preset banks, compile banks, or control banks. Please select one of the user banks.
55	Special tracks such as CHORD (APC), RHY and CTL exist in the song from which you are copying and are incompatible with the destination song because it is in the GM mode.

No.	Contents
56	AUTO PUNCH recording has been unsuccessful because SEQUENCER operation was interrupted before the PUNCH OUT measure was reached.
58	The song that you have tried to load exceeds this instrument's available memory and cannot be loaded. The selected song memory has been cleared.
62	The computer connection is not active because the computer port switch is set to MIDI. Please turn the power off, set the switch to the desired setting and turn the power back on.
63	This Bitmap is in the wrong format for the KN and cannot be loaded. See the Owners Manual for more details.
64	Please select the Panel Memory that you want to name.
65	It is not possible to use the CHORD FINDER in this mode. Please select CHORD FINDER from HOME page or CHORD STEP RECORD page.
66	SOLO pads are special pads which include Chord information. Please use SOLO pads when the rhythm and accompaniment is playing.
67	There are no APC or CHORD tracks. Select and APC track or CHORD track, and try again.
68	It is not possible to record directly into the SOLO pads. Record on the SEQUENCER and Copy the melody and chord information into a SOLO pad.
69	It is not possible to delete all measures.
70	It is not possible to insert over 16 measures in a PATTERN.
71	It is not possible to set the start measure to the measures you set to copy.

Index

A	
ADVANCED	53
AMPLITUDE	165
APC CONTROL (MIDI)	182
AUTO PLAY CHORD	52
AUTO PLAY CHORD INPUT (MIDI)	183
AUTO PLAY CHORD OUTPUT (MIDI)	184
AUTO SETTING	68

B	
BACKUP	117
Backup memory	187
BANK	67
BANK VIEW	64
BASIC	53
BEAT	50
BEND RANGE	149

C	
CHORD FINDER	55
CHORD STEP RECORD	92
CHORUS	43
CLOCK (MIDI)	181
COMMON SETTING (MIDI)	182
COMPOSER	104
COMPUTER CONNECTION	185
CONDUCTOR	39
CONTRAST	32
CONTROL	171
CONTROL MESSAGES (MIDI)	181
COUNT INTRO	51
CUSTOMIZE	174

D	
DEMO	16
DIGITAL DRAWBAR	37
DIGITAL EFFECT	41
DIRECT PLAY (KN2400)	122
Disk Drive (KN2400)	117
DISK (KN2400)	119
Display	30
DISPLAY TIME OUT	175
DISPLAY HOLD	32
DRUM EDIT	95
DRUM PATTERN OUTPUT (MIDI)	184
DRUMS TYPE (MIDI)	182

E	
EASY COMPOSER	106
EASY EDIT	158
EASY REC	77
Error messages	191
EXIT	32
EXP PEDAL	188
Expression Pedal	187

F	
FADE IN/OUT	57
FAVORITES	33
FILL IN	51
FILTER	163
FINGERED	53
FOOT CONTROLLERS	172
FOOT SW	188
Foot Switch	187

G	
GENERAL MIDI LEVEL 2	118
GLIDE	172

H	
Headphones	188
HELP	33

I	
INITIAL	186
INPUT/OUTPUT SETTING (MIDI)	183
INTRO & ENDING	51

K	
KEY SCALING	152
KEY SHIFT	147

L	
LANGUAGE SELECT	33
LEFT HOLD	55
LFO	167
LINE OUT	188
LOAD (DISK)	120
LOAD (SD)	130
LOCAL (MIDI)	180

M	
MAIN VOLUME	15
MASTER TUNING	152
MEASURE COPY	98
MEASURE ERASE	99
MEASURE & TIME SIGNATURE	107
MEMORY, AUTO PLAY CHORD	54
MEMORY, RHYTHM GROUP	111
MEMORY, SOUND GROUP	170
Menu	31
MIC	188
MIDI	177
MIDI PRESETS	184
MIDI SETTING LOAD OPTION	176
MIXER	150
MODULATION (KN2600)	45
MULTI EFFECT	42
Music stand	14
MUSIC STYLIST	60

MUSIC STYLE ARRANGER	62
MUTE	30
N	
NOTE EDIT	94
NOTE ONLY (MIDI)	182
O	
ON BASS	54
ONE TOUCH PLAY	60
Options	187
OTHER PARTS/TR	31
OVERALL TOUCH SENSITIVITY	172
P	
PAGE	31
PAN	147
PANEL MEMORY	64
PART SELECT	36
PART SETTING (SOUND)	147
PART SETTING (MIDI)	180
PATTERN COPY	115
PERFORMANCE	117
PERFORMANCE PADS	67
PIANIST	54
PITCH	162
PITCH BEND	45
PROGRAM CHANGE MODE (MIDI)	182
PUNCH RECORD	84
Q	
QUANTIZE, COMPOSER	108
QUANTIZE, SEQUENCER	92
R	
REALTIME COMMANDS (MIDI)	181
REALTIME RECORD	78
REVERB	43
RHYTHM GROUP	49
RIGHT 1 INPUT (MIDI)	183
S	
SAVE (DISK) (KN2400)	125
SAVE (SD) (KN2600)	140
SD CARD (KN2600)	131
SET	64
SEQUENCER	73
SEQUENCER PLAY	81
SEQUENCER RESET	81
SEQUENCER SONG SAVE	127
SOLO	67
SONG CLEAR	93
SONG SELECT	84
SOUND	146
SOUND ARRANGER	59
SOUND EXPLORER	37
SOUND EDIT	157
SOUND GROUP	36
Specifications	195

SPLIT POINT	40
Standard MIDI File	118
START/STOP	51
STEP RECORD	86
STEP RECORD: CHORD	88
STEP RECORD: RHYTHM	90
STOP	67
SUSTAIN	41
SYNCHRO & BREAK	50
T	
TAP TEMPO	50
TECHNI-CHORD	47
TEMPO/PROGRAM	50
TONE	159
TONE CONTROL	156
TONE SELECT	159
TRACK ASSIGN	91
TRACK CLEAR	93
TRACK MERGE	98
TRANSPOSE	46
Troubleshooting	190
U	
USB	188
V	
VARIATION	49
VELOCITY CHANGE	102
Volume balance	30

Specifications

		SX-KN2400	SX-KN2600
KEYBOARD		61 KEYS (WITH INITIAL TOUCH)	
SOUND GENERATOR		PCM	
MAX. POLYPHONY		64 NOTES	
SOUNDS	NUMBER OF SOUNDS	1024 SOUNDS (990 SOUNDS +2 ORGAN DRAWBARS + 32 DRUM KITS)	1064 SOUNDS (1030 SOUNDS +2 ORGAN DRAWBARS + 32 DRUM KITS)
	SOUND GROUP	PIANO, GUITAR & HARPSI, STRINGS & VOCAL, BRASS, MALLET & ORCH PERC, ORGAN & ACCORDION, SAX & WOODWIND, SYNTH, BASS, DRUM KITS, DIGITAL DRAWBAR	
	SOUND EXPLORER	○	
EFFECT		SUSTAIN, DIGITAL EFFECT, MULTI EFFECT, REVERB, CHORUS	
WHEEL		PITCH BEND	PITCH BEND, MODULATION
PART SELECT		RIGHT 1, RIGHT 2, LEFT	
TRANPOSE		±12 NOTES	
RHYTHMS	NUMBER OF RHYTHMS	170 RHYTHMS × 4 VARIATIONS	
	RHYTHM GROUP	POP, ROCK, BALLAD, JAZZ & SWING, DANCE POP, SIMPLE BEAT, DANCE CLUB, TRAD & WALTZ, BALLROOM & SHOW, LATIN & WORLD, USA	
FAVORITES		○	
CONTROLS		MAIN VOLUME, MIC VOLUME, BALANCE, MUTE, CONDUCTOR, START/STOP, INTRO & ENDING 1, INTRO & ENDING 2, FILL IN 1, FILL IN 2, COUNT INTRO, SYNCHRO&BREAK, TEMPO/PROGRAM, TAP TEMPO, FADE IN/OUT, SPLIT POINT	
PERFORMANCE PADS		20 PRESET BANKS × 6 PADS WITH SOLO, USER BANK × 3, COMPILER BANKS × 2, CONTROL PRESET × 1, STOP, AUTO SETTING	
AUTO PLAY CHORD		MODE: BASIC, ADVANCED 1, 2, PIANIST MEMORY, ON BASS, CHORD FINDER, LEFT HOLD	
MUSIC STYLE ARRANGER		○	
SOUND ARRANGER		○	
MUSIC STYLIST		○	
ONE TOUCH PLAY		○	
TECHNI-CHORD		○	
PANEL MEMORY		3 BANKS × 8, SET, NEXT BANK, BANK VIEW	
SEQUENCER		16 TRACKS RESOLUTION: 1/96 PER BEAT STORAGE CAPACITY: APPROX.40000 NOTES (10 SONG MAX.) INPUT MODES: EASY RECORD, REALTIME RECORD, STEP RECORD FUNCTIONS: RECORD & EDIT, COPY & PASTE, RANGE EDIT	
COMPOSER		8 PARTS: BASS, ACCOMP 1 – 5, DRUMS 1, 2 STORAGE CAPACITY: APPROX. 13000 NOTES INPUT MODES: EASY COMPOSER, REALTIME RECORD, STEP RECORD FUNCTIONS: PATTERN COPY, SEQ TO COMPOSER COPY, LOAD SINGLE COMPOSER MEMORY: 3 BANKS	
DISK		3.5 inch DISK DRIVE for 2HD (1.44MB), 2DD (720KB) LOAD, SAVE, DIRECT PLAY, SONG MEDLEY, DISK TOOLS, PREFERENCES	—

	SX-KN2400	SX-KN2600
SD CARD	—	LOAD, SAVE, FAVORITE SONGS, SD SONG MEDLEY, SD-AUDIO PLAY, SD-SOUND PLAY, SD TOOLS, SD PREFERENCES
SOUND	PART SETTING, MIXER, MASTER TUNING, KEY SCALING, TECHNI-CHORD, SOUND LOAD OPTION, APC REVERB SETTING, SOUND ARRANGER	
SOUND EDIT	EASY EDIT, TONE, PITCH, FILTER, AMPLITUDE, LFO, EFFECT, CONTROLLER MEMORY: 40, 1 USER DRUM KIT	
REVERB & EFFECT	MIC REVERB & EFFECT, SOUND LOAD OPTION, MIXER, MULTI, CHORUS, REVERB, TONE CONTROL	
CONTROL	INITIAL, OVERALL TOUCH SENSITIVITY, FOOT CONTROLLERS PANEL MEMORY MODE, MUSIC STYLE ARRANGER MODE, FADE IN/OUT SETTING	
CUSTOMIZE	FAVORITE SETTING, DISPLAY TIME OUT, MIDI SETTING LOAD OPTION, DATA PROTECTION, LANGUAGE SETTING, DISK PREFERENCES (KN2400)/SD PREFERENCES (KN2600)	
MIDI	PART SETTING, CONTROL MESSAGES, REALTIME MESSAGES, COMMON SETTING, INPUT/OUTPUT SETTING, MIDI PRESETS, MODE SETTING, COMPUTER CONNECTION	
DISPLAY	LCD PAGE, CONTRAST, EXIT, DISPLAY HOLD	
HELP	○	
DEMO	○	
TERMINALS	PHONES, FOOT SW, EXP PEDAL, LINE OUT (R/MONO, L), MIDI (IN, OUT), USB, MIC	
OUTPUT	36 W (18 W × 2)	40 W (20 W × 2)
SPEAKERS	12 cm × 2, 6.5 cm × 2	
POWER REQUIREMENT	75 W AC120/220/230–240V 50/60 Hz AC120V 60 Hz (NORTH AMERICA AND MEXICO) AC220–240V 50/60 Hz (EUROPE, AUSTRALIA AND NEW ZEALAND)	
DIMENSIONS (W × H × D)	105.7 cm × 16.2 cm × 40.4 cm (41-5/8" × 6-3/8" × 15-29/32")	
NET WEIGHT	11.7 kg (25.8 lbs)	11.4 kg (25.1 lbs)
ACCESSORIES	AC CORD, MUSIC STAND, CD-ROM (AUDIO RECORDER, SONG MANAGER, USB DRIVER)	AC CORD, MUSIC STAND, CD-ROM (AUDIO RECORDER, SONG MANAGER, USB DRIVER), SD CARD

- Design and specifications are subject to change without notice.
- The SD logo is a trademark. 

(For U.S.A.)

PANASONIC CONSUMER ELECTRONICS COMPANY,
DIVISION OF MATSUSHITA ELECTRIC CORPORATION OF AMERICA
One Panasonic Way, Secaucus, New Jersey 07094

PANASONIC SALES COMPANY, DIVISION OF MATSUSHITA ELECTRIC
OF PUERTO RICO, INC.,
Ave. 65 de Infantería, Km. 9.5
San Gabriel Industrial Park, Carolina, Puerto Rico 00985

Panasonic / Technics Musical Instrument Products Limited Warranty

Limited Warranty Coverage

If your product does not work properly because of a defect in materials or workmanship, Panasonic Consumer Electronics Company or Panasonic Sales Company (collectively referred to as "the warrantor") will, for the length of the period indicated on the chart below, which starts with the date of original purchase ("warranty period"), at its option either (a) repair your product with new or refurbished parts, or (b) replace it with a new or a refurbished product. The decision to repair or replace will be made by the warrantor.

Product	Parts	Labor	Service
Technics Organs, Digital Pianos, Digital Ensemble Series, Tone Cabinets, Panasonic Digital Pianos	Three (3) Years	One (1) Year	In-Home or Carry-In
Technics Keyboards	One (1) Year	One (1) Year	In-Home or Carry-In
Panasonic Keyboards, Synthesizers, Sound Modules, Expansion Boards, Disk Drives, Drum Percussion Units, MIDI Orchestra, Keyboard Amplifiers, Foot Pedals, Foot Controllers, Personal Music PA Systems	One (1) Year	One (1) Year	Carry-In or Mail-In
USB Reader/Writer, Personal Computer Card Adapters (in exchange for defective item)	One (1) Year	Not Applicable	Carry-In or Mail-In
SD Memory Cards (in exchange for defective item)	Ninety (90) Days	Not Applicable	Carry-In or Mail-In

During the "Labor" warranty period there will be no charge for labor. During the "Parts" warranty period, there will be no charge for parts. You must carry-in or mail-in your product or arrange for in-home service, as applicable, during the warranty period. If non-rechargeable batteries are included, they are not warranted. This warranty only applies to products purchased and serviced in the United States or Puerto Rico. This warranty is extended only to the original purchaser of a new product which was not sold "as is". A purchase receipt or other proof of the original purchase date is required for warranty service.

Carry-In, Mail-In or In-Home Service

For Carry-In, Mail-In or In-Home Service (as applicable) in the United States call 1-800-211-PANA(7262) or visit the website (<http://www.panasonic.com>).
For assistance in Puerto Rico call Panasonic Sales Company (787)-750-4300 or fax (787)-768-2910.

In-Home service, if applicable, requires clear, complete and easy access to the product by the authorized servicer and does not include removal or re-installation of an installed product. It is possible that certain in-home repairs will not be completed in-home, but will require that the product, or parts of the product, be removed for shop diagnosis and/or repair and then returned.

Limited Warranty Limits And Exclusions

This warranty ONLY COVERS failures due to defects in materials or workmanship, and DOES NOT COVER normal wear and tear or cosmetic damage. The warranty ALSO DOES NOT COVER damages which occurred in shipment, or failures which are caused by products not supplied by the warrantor, or failures which result from accidents, misuse, abuse, neglect, mishandling, misapplication, alteration, faulty installation, set-up adjustments, misadjustment of consumer controls, improper maintenance, power line surge, lightning damage, modification, rental use of the product, service by anyone other than a Factory Servicenter or other Authorized Servicer, or damage that is attributable to acts of God.

THERE ARE NO EXPRESS WARRANTIES EXCEPT AS LISTED UNDER "LIMITED WARRANTY COVERAGE". THE WARRANTOR IS NOT LIABLE FOR INCIDENTAL OR CONSEQUENTIAL DAMAGES RESULTING FROM THE USE OF THIS PRODUCT, OR ARISING OUT OF ANY BREACH OF THIS WARRANTY, INCLUDING WITHOUT LIMITATION, LOSS OF GOODWILL, PROFITS OR REVENUE, LOSS OF USE OF THIS PRODUCT OR ANY ASSOCIATED EQUIPMENT, COST OF SUBSTITUTE EQUIPMENT, DOWNTIME COSTS, OR CLAIMS OF ANY PARTY DEALING WITH BUYER FOR SUCH DAMAGES. (As examples, this excludes damages for lost time, cost of having someone remove or re-install an installed unit if applicable, travel to and from the servicer, loss of media, data or other memory content. The items listed are not exclusive, but are for illustration only.) **ALL EXPRESS AND IMPLIED WARRANTIES, INCLUDING THE WARRANTY OF MERCHANTABILITY, ARE LIMITED TO THE PERIOD OF THE LIMITED WARRANTY.**

Some states do not allow the exclusion or limitation of incidental or consequential damages, or limitations on how long an implied warranty lasts, so the exclusions may not apply to you.

This warranty gives you specific legal rights and you may also have others rights which vary from state to state. If a problem with this product develops during or after the warranty period, you may contact your dealer or Servicenter. If the problem is not handled to your satisfaction, then write to the warrantor's Consumer Affairs Department at the addresses listed for the warrantor.

PARTS AND SERVICE (INCLUDING COST OF AN IN-HOME SERVICE CALL IF APPLICABLE) WHICH ARE NOT COVERED BY THIS LIMITED WARRANTY ARE YOUR RESPONSIBILITY.

Customer Services Directory

**For Product Information, Operating Assistance, Literature Request, Dealer Locations, and all Customer Service inquiries please contact:
1-800-211-PANA (7262), Monday-Friday 9 am-9 pm; Saturday-Sunday 9 am-7pm, EST.**

**Web site: <http://www.panasonic.com>
You can purchase parts, accessories or locate your nearest servicenter by visiting our Web Site.**

Accessory Purchases:

1-800-332-5368 (Customer Orders Only)
Panasonic Servicses Company 20421 84th Avenue South, Kent, WA 98032
(6 am to 5 pm Monday-Friday; 6 am to 10:30 am Saturday; PST)
(Visa, MasterCard, Discover Card, American Express, Check)

**Service in Puerto Rico
Matsushita Electric of Puerto Rico, Inc. Panasonic Sales Company/Factory Servicenter:
Ave. 65 de Infantería, Km. 9.5, San Gabriel Industrial Park, Carolina, Puerto Rico 00985
Phone (787) 750-4300 Fax (787) 768-2910**

MEMO

MEMO

Matsushita Electric Industrial Co., Ltd.

Web Site: <http://www.panasonic.co.jp/global/>