



DR-202

Dr.Groove

Owner's Manual

Thank you, and congratulations on your choice of the BOSS DR-202 Dr. Groove.

Before using this unit, carefully read the sections entitled:

- USING THE UNIT SAFELY (page 2-3)
- IMPORTANT NOTES (page 8)

These sections provide important information concerning the proper operation of the unit.

Additionally, in order to feel assured that you have gained a good grasp of every feature provided by your new unit, Owner's manual should be read in its entirety. The manual should be saved and kept on hand as a convenient reference.

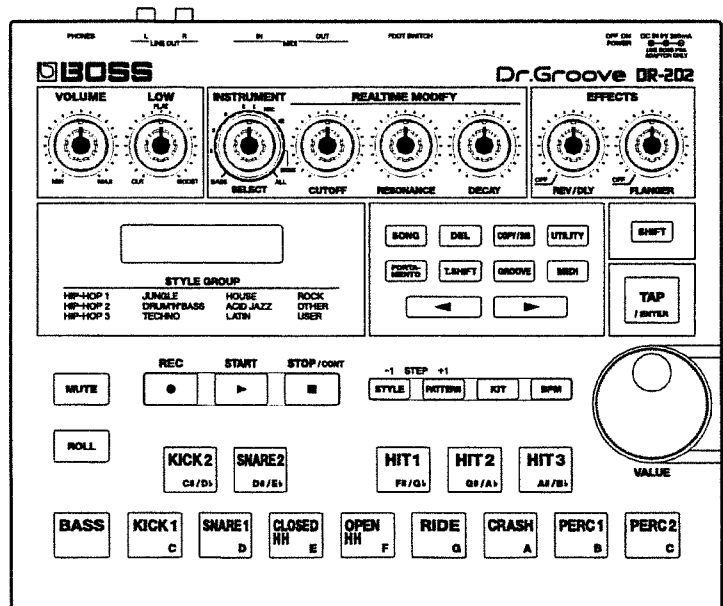

USING THE UNIT SAFELY

INSTRUCTIONS FOR THE PREVENTION OF FIRE, ELECTRIC SHOCK, OR INJURY TO PERSONS

About ⚠ WARNING and ⚠ CAUTION Notices

⚠ WARNING	Used for instructions intended to alert the user to the risk of death or severe injury should the unit be used improperly.
⚠ CAUTION	Used for instructions intended to alert the user to the risk of injury or material damage should the unit be used improperly. * Material damage refers to damage or other adverse effects caused with respect to the home and all its furnishings, as well to domestic animals or pets.

About the Symbols

	The ⚠ symbol alerts the user to important instructions or warnings. The specific meaning of the symbol is determined by the design contained within the triangle. In the case of the symbol at left, it is used for general cautions, warnings, or alerts to danger.
	The ⚡ symbol alerts the user to items that must never be carried out (are forbidden). The specific thing that must not be done is indicated by the design contained within the circle. In the case of the symbol at left, it means that the unit must never be disassembled.
	The ● symbol alerts the user to things that must be carried out. The specific thing that must be done is indicated by the design contained within the circle. In the case of the symbol at left, it means that the power-cord plug must be unplugged from the outlet.

ALWAYS OBSERVE THE FOLLOWING







⚠ WARNING

- Before using this unit, make sure to read the instructions below, and the Owner's Manual.
- Do not open (or modify in any way) the unit or its AC adaptor.
- Do not attempt to repair the unit, or replace parts within it (except when this manual provides specific instructions directing you to do so). Refer all servicing to your retailer, the nearest Roland Service Center, or an authorized Roland distributor, as listed on the "Information" sheet.
- Never use or store the unit in places that are:
 - Subject to temperature extremes (e.g., direct sunlight in an enclosed vehicle, near a heating duct, on top of heat-generating equipment); or are
 - Damp (e.g., baths, washrooms, on wet floors); or are
 - Humid; or are
 - Dusty; or are
 - Subject to high levels of vibration.
- Make sure you always have the unit placed so it is level and sure to remain stable. Never place it on stands that could wobble, or on inclined surfaces.
- Use only the specified AC adaptor (PSA-120/230/240), and make sure the line voltage at the installation matches the input voltage specified on the AC adaptor's body. Other AC adaptors may use a different polarity, or be designed for a different voltage, so their use could result in damage, malfunction, or electric shock.







⚠ WARNING

- Avoid damaging the power cord. Do not bend it excessively, step on it, place heavy objects on it, etc. A damaged cord can easily become a shock or fire hazard. Never use a power cord after it has been damaged.
- This unit, either alone or in combination with an amplifier and headphones or speakers, may be capable of producing sound levels that could cause permanent hearing loss. Do not operate for a long period of time at a high volume level, or at a level that is uncomfortable. If you experience any hearing loss or ringing in the ears, you should immediately stop using the unit, and consult an audiologist.
- Do not allow any objects (e.g., flammable material, coins, pins); or liquids of any kind (water, soft drinks, etc.) to penetrate the unit.
- Immediately turn the power off, remove the AC adaptor from the outlet, and request servicing by your retailer, the nearest Roland Service Center, or an authorized Roland distributor, as listed on the "Information" page when:
 - The AC adaptor or the power-supply cord has been damaged; or
 - Objects have fallen into, or liquid has been spilled onto the unit; or
 - The unit has been exposed to rain (or otherwise has become wet); or
 - The unit does not appear to operate normally or exhibits a marked change in performance.







WARNING

- In households with small children, an adult should provide supervision until the child is capable of following all the rules essential for the safe operation of the unit. 
- Protect the unit from strong impact. (Do not drop it!) 
- Do not force the unit's power-supply cord to share an outlet with an unreasonable number of other devices. Be especially careful when using extension cords—the total power used by all devices you have connected to the extension cord's outlet must never exceed the power rating (watts/amperes) for the extension cord. Excessive loads can cause the insulation on the cord to heat up and eventually melt through. 
- Before using the unit in a foreign country, consult with your retailer, the nearest Roland Service Center, or an authorized Roland distributor, as listed on the "Information" sheet. 
- Batteries must never be recharged, heated, taken apart, or thrown into fire or water. 

CAUTION

- The unit and the AC adaptor should be located so their location or position does not interfere with their proper ventilation. 
- Always grasp only the plug or the body of the AC adaptor when plugging into, or unplugging from, an outlet or this unit. 
- Whenever the unit is to remain unused for an extended period of time, disconnect the AC adaptor. 
- Try to prevent cords and cables from becoming entangled. Also, all cords and cables should be placed so they are out of the reach of children. 
- Never climb on top of, nor place heavy objects on the unit. 
- Never handle the AC adaptor body, or its plugs, with wet hands when plugging into, or unplugging from, an outlet or this unit. 
- Before moving the unit, disconnect the AC adaptor and all cords coming from external devices. 

CAUTION

- Before cleaning the unit, turn off the power and unplug the AC adaptor from the outlet. 
- Whenever you suspect the possibility of lightning in your area, disconnect the AC adaptor from the outlet. 
- If used improperly, batteries may explode or leak and cause damage or injury. In the interest of safety, please read and observe the following precautions (p.7). 

 - Carefully follow the installation instructions for batteries, and make sure you observe the correct polarity. 
 - Avoid using new batteries together with used ones. In addition, avoid mixing different types of batteries.
 - Whenever the unit is to remain unused for an extended period of time, save any important data in another MIDI device (e.g., a sequencer), and then remove the batteries.
 - If a battery has leaked, use a soft piece of cloth or paper towel to wipe all remnants of the discharge from the battery compartment. Then install new batteries. To avoid inflammation of the skin, make sure that none of the battery discharge gets onto your hands or skin. Exercise the utmost caution so that none of the discharge gets near your eyes. Immediately rinse the affected area with running water if any of the discharge has entered the eyes.
 - Never keep batteries together with metallic objects such as ballpoint pens, necklaces, hairpins, etc.
- Used batteries must be disposed of in compliance with whatever regulations for their safe disposal that may be observed in the region in which you live. 

Contents

Features of the DR-202.....	5
Front and Rear Panel.....	6
Inserting the batteries	7
IMPORTANT NOTES	8

Quick Start 9

Making Connections/Switching Power On/Off	9
Let's Listen to a Demo Song	12
How to Play Patterns.....	14
How to Change Kits	15
Let's Turn the Dials to Change the Tone	16
Let's Record a Pattern.....	18
Let's Make a Song	20
Restoring the Original Factory Settings (Factory Reset)	22

Chapter 1 Overview of the DR-202 24

Organization of the DR-202.....	24
About the Sound Generator	24
About the Sequencer.....	25
Organization of Modes.....	26

Chapter 2 Performing Patterns and Songs 27

Performing Patterns.....	27
Performing Songs.....	27
Changing the Tempo (BPM).....	28
Changing the Kit.....	29
Modifying a tone in real time using the control knobs (Realtime Modify).....	29
Adding Effects.....	30
Muting for Each Instrument.....	32

Chapter 3 Performing with the Pads 33

Playing Drums.....	33
Performing with Bass Sounds	35
Performing with an External MIDI Sound Module.....	36

Chapter 4 Recording Patterns 37

A Note About Recording	37
Realtime Recording.....	38
Step Recording	41

Chapter 5 Editing Patterns 45

Editing of Patterns	45
Giving a Groove to the pattern (Groove Quantize)	47
Changing the Pattern Setup Information	48
Deleting Patterns.....	50
Copying Patterns.....	50

Chapter 6 Creating Songs 52

About Recording.....	52
Creating Songs (Song Recording).....	52
Deleting Songs.....	53
Copying Songs.....	54

Chapter 7 Creating Original Kits 55

Changing the Kit Setup	55
Copying a Kit.....	56

Chapter 8 Connecting External MIDI Devices 57

What is MIDI?.....	57
MIDI Settings.....	58
Synchronizing Performances with External MIDI Devices	61
Controlling an SP-202 or MS-1.....	62

Chapter 9 Other Functions (Utility Mode) 63

Utility Settings.....	63
-----------------------	----

Troubleshooting 64

Error Message List 67

Parameter List 68

Instrument List 70

Preset Kit List 71

Preset Pattern List 72

Roll Types List 78

Groove Template List 79

MIDI Implementation 80

MIDI Implementation Chart 88

Specifications 89

Index 90

Blank Chart 93

Features of the DR-202

Ultra-Powerful Dance Rhythm Machine

Features bass parts in addition to drums, and comes loaded with 400 different preset patterns that can be accessed instantaneously for hip-hop, trip-hop, drum'n'bass, and minimal techno.

Contains All Kinds of Sounds for Dance Music

While of course offering a complete collection of vintage sounds from machines such as the TR-808/909 and TB-303, the DR-202 additionally contains a range of new sounds ideal for hip-hop, including "plastic" sounds.

Control Features Suited to Live Performance

Features a Real-Time Modify function which allows you to alter the sound in real time, simply by adjusting the control knobs while a pattern is being played. It also features a mute function, which allows you to instantaneously mute a particular part or rhythm instrument; and a Roll function, which allows ultra-high speed rolls of the drum'n'bass type. With these features, more effective live performances are assured.

Combines Easily with Analog Disks

With its one-touch return-to-top-of-song feature, and tap-it-in BPM matching, the unit can be effectively used for playing in sync with analog disks.

Quick and Easy Creation Of Various "Grooves"

The unit's Groove Quantize function allows you to create many different types of "grooves," such as "shuffle beat" and "groovy."

Front and Rear Panel

■ Front Panel

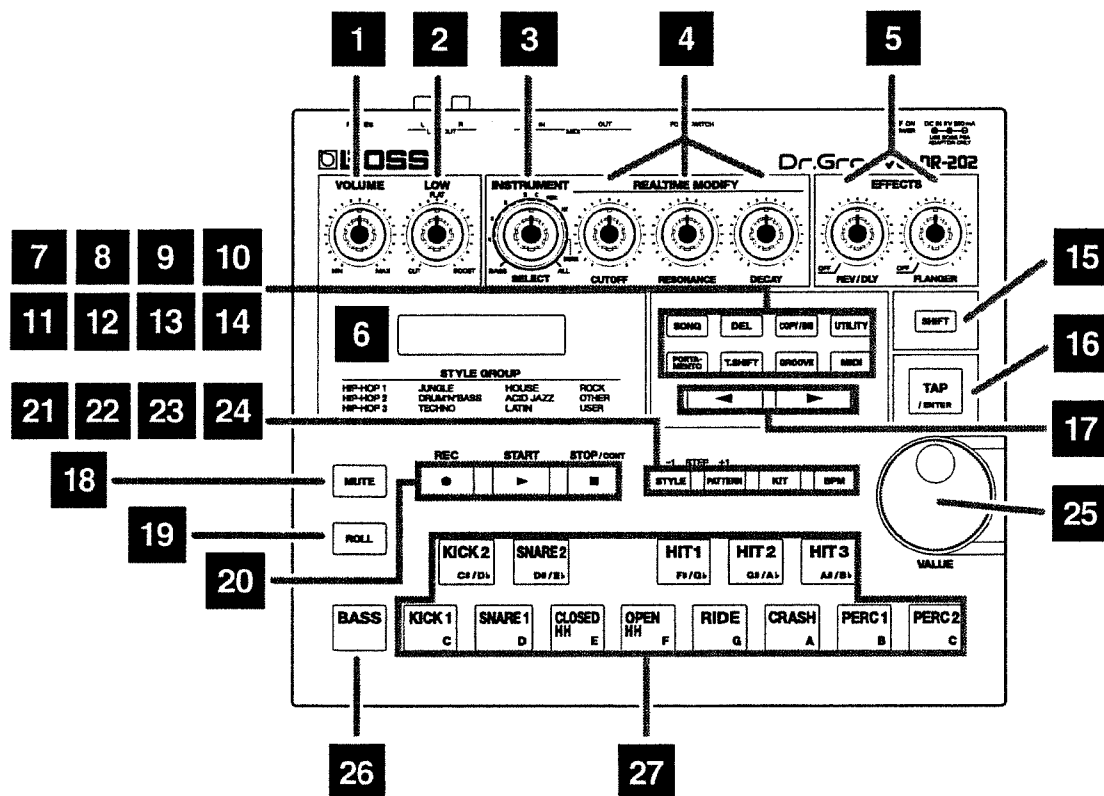

- | | |
|---|--|
| 1 Volume knob.....(p.11) | 14 MIDI button(p.60) |
| 2 Low knob(p.16) | 15 Shift button(p.13, 28, 32, 43, 45, 49, 62) |
| 3 Instrument knob.....(p.16) | 16 Tap/Enter button(p.23, 25, 29) |
| 4 Realtime Modify knobs.....(p.16, 29) | 17 Cursor key |
| • Cutoff | 18 Mute button(p.23, 25, 32, 49) |
| • Resonance | 19 Roll button(p.23, 25, 33, 34) |
| • Decay | 20 Sequencer Section.....(p.18, 20) |
| 5 Effects knobs(p.16, 17, 29) | • Record button |
| • Reverb/Delay | • Start button |
| • Flanger | • Stop/Continue button |
| 6 Display | 21 Style button(p.18, 27, 38, 41, 45) |
| 7 Song button.....(p.12, 20, 27, 52) | 22 Pattern button.....(p.14, 26, 27, 38, 41, 45) |
| 8 Delete button(p.50, 53) | 23 Kit button(p.15, 25, 29, 40, 48, 55) |
| 9 Copy/Insert button(p.50, 54, 56) | 24 BPM button(p.25, 28, 39) |
| 10 Utility button.....(p.63) | 25 Value dial |
| 11 Portamento button(p.35, 43) | 26 Bass button(p.11, 33, 55) |
| 12 Timing Shift button(p.46) | 27 Pads(p.11, 24, 32) |
| 13 Groove button(p.48) | |

■ Rear Panel

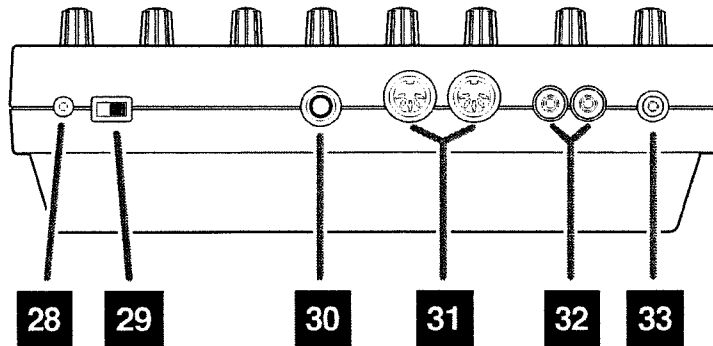

28 AC Adaptor jack(p.9)

29 Power switch(p.11)

30 Foot switch jack(p.10, 63)

31 MIDI connectors (IN/OUT)(p.57)

32 Output jacks (L/R)(p.10)

33 Headphone jack(p.10)

Inserting the batteries

Detach the lid of the battery case located on the bottom of the unit, and referring to the diagrams on the bottom, insert the batteries making sure to observe the correct polarity. Then close the lid firmly.

* When replacing the batteries, use six AA batteries. Also, do not mix new and old batteries or batteries of different types. Doing so may cause fluid to leak from the batteries.

* Battery life may vary according to battery type.

* Expected battery life under continuous use:

Alkaline: Approx. 8 hours

Carbon: Approx. 4 hours

These figures will vary depending on the actual conditions of use.

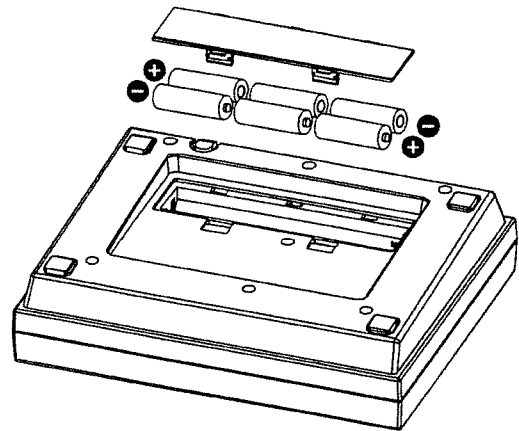

IMPORTANT NOTES

In addition to the items listed under "USING THE UNIT SAFELY" on page 2 and 3, please read and observe the following:

Power Supply: Use of Batteries

- Do not use this unit on the same power circuit with any device that will generate line noise (such as an electric motor or variable lighting system).
- The AC adaptor will begin to generate heat after long hours of consecutive use. This is normal, and is not a cause for concern.
- When installing or replacing batteries, always turn off the power on this unit and disconnect any other devices you may have connected. This way, you can prevent malfunction and/or damage to speakers or other devices.
- Batteries are supplied with the unit. The life of these batteries may be limited, however, since their primary purpose was to enable testing.
- Before connecting this unit to other devices, turn off the power to all units. This will help prevent malfunctions and/or damage to speakers or other devices.

Placement

- Using the unit near power amplifiers (or other equipment containing large power transformers) may induce hum. To alleviate the problem, change the orientation of this unit; or move it farther away from the source of interference.
- This device may interfere with radio and television reception. Do not use this device in the vicinity of such receivers.
- Do not expose the unit to direct sunlight, place it near devices that radiate heat, leave it inside an enclosed vehicle, or otherwise subject it to temperature extremes. Excessive heat can deform or discolor the unit.

Maintenance

- For everyday cleaning wipe the unit with a soft, dry cloth or one that has been slightly dampened with water. To remove stubborn dirt, use a cloth impregnated with a mild, non-abrasive detergent. Afterwards, be sure to wipe the unit thoroughly with a soft, dry cloth.
- Never use benzine, thinners, alcohol or solvents of any kind, to avoid the possibility of discoloration and/or deformation.

Repairs and Data

- Please be aware that all data contained in the unit's memory may be lost when the unit is sent for repairs. Important data should always be backed up in another MIDI device (e.g., a sequencer), or written down on paper (when possible). During repairs, due care is taken to avoid the loss of data. However, in certain cases (such as when circuitry related to memory itself is out of order), we regret that it may not be possible to restore the data, and Roland assumes no liability concerning such loss of data.

Memory Backup

- This unit contains a battery which powers the unit's memory circuits while the main power is off. When this battery becomes weak, the message shown below will appear in the display. Once you see this message, have the battery replaced with a fresh one as soon as possible to avoid the loss of all data in memory. To have the battery replaced, consult with your retailer, the nearest Roland Service Center, or an authorized Roland distributor, as listed on the "Information" sheet.

"Backup Battery Low !"

Additional Precautions

- Please be aware that the contents of memory can be irretrievably lost as a result of a malfunction, or the improper operation of the unit. To protect yourself against the risk of losing important data, we recommend that you periodically save a backup copy of important data you have stored in the unit's memory in another MIDI device (e.g., a sequencer).
- Unfortunately, it may be impossible to restore the contents of data that was stored in another MIDI device (e.g., a sequencer) once it has been lost. Roland Corporation assumes no liability concerning such loss of data.
- Use a reasonable amount of care when using the unit's buttons, sliders, or other controls; and when using its jacks and connectors. Rough handling can lead to malfunctions.
- Never strike or apply strong pressure to the display.
- When connecting / disconnecting all cables, grasp the connector itself—never pull on the cable. This way you will avoid causing shorts, or damage to the cable's internal elements.
- To avoid disturbing your neighbors, try to keep the unit's volume at reasonable levels. You may prefer to use headphones, so you do not need to be concerned about those around you (especially when it is late at night).
- When you need to transport the unit, package it in the box (including padding) that it came in, if possible. Otherwise, you will need to use equivalent packaging materials.

Quick Start

Printing Conventions in This Manual

In order to present information as clearly as possible, the following conventions are used in this manual.

- Text or numerals enclosed in square brackets [] indicate buttons. For example [SONG] indicates the Song button.
- References such as (p.***) indicate pages in this manual to which you can refer.

Making Connections/Switching Power On/Off

Making the Connections

1. Check that the following is true for all equipment being connected:
 - The power switch is turned off.
 - The volume is turned down completely.
2. Connect the AC adapter (BOSS PSA Series; optional) to the AC adaptor jack and plug it into a wall socket or other power outlet.

The AC adaptor can be used to run the DR-202 from a household electrical outlet.

* Omit this step when running the unit on batteries.

* Use only a dedicated AC adaptor (BOSS PSA Series). Never try to use another AC adaptor, because doing so may result in incorrect operation or breakdown.

* To prevent the inadvertent disruption of power to your unit (should the plug be pulled out accidentally), and to avoid applying undue stress to the AC adaptor jack, anchor the power cord using the cord hook, as shown in the illustration..

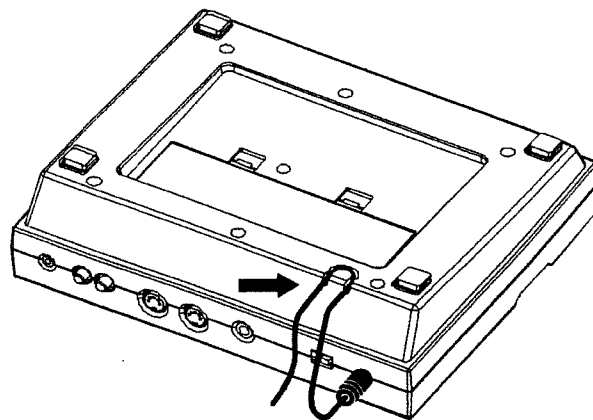

3. Connect audio and MIDI cables as shown in the diagram.

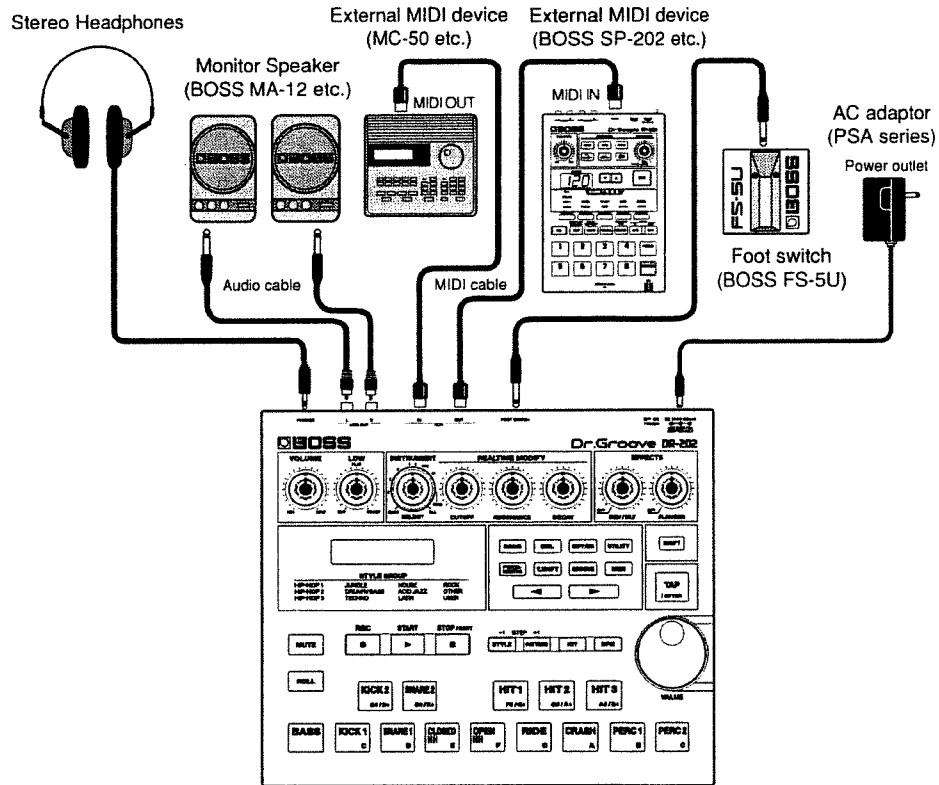

- * To prevent malfunction and/or damage to speakers or other devices, always turn down the volume, and turn off the power on all devices before making any connections.
- * When connecting a foot switch (FS-5U; optional) to the FOOT SWITCH jack, set the polarity switch as described below.

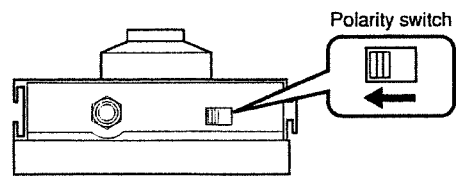

Turning the Power On

Once the connections have been completed, turn on power to your various devices in the order specified. By turning on devices in the wrong order, you risk causing malfunction and/or damage to speakers and other devices.

- 1. Confirm the following before turning on the power to the unit:**
 - All connections have been made properly.
 - The volume is completely turned down.

* Even with the volume turned all the way down, you may hear some sound when turning on the power to your equipment. This does not indicate a malfunction. Remove headphones before turning on the power.

2. Press the POWER switch on the rear panel of the DR-202.

This unit is equipped with a protection circuit. A brief interval (a few seconds) after power up is required before the unit will operate normally.

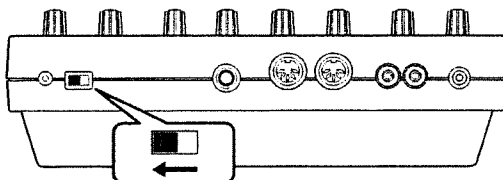

3. Turn on the power to the other connected devices.

4. Raise the volume by turning the volume knob while tapping the DR-202's pad until a suitable volume is reached.

* After the power is turned on, drum sounds are produced when the pads (the black buttons arranged as a keyboard at the front) are tapped. To get bass sounds, press [BASS], so that [BASS] is lit.

* When connected to an external amp, first bring up the amp volume slightly before starting to rotate the DR-202's volume knob.

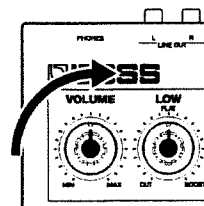
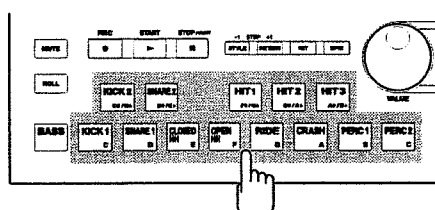

Turning the Power Off

1. Confirm the following before turning off the power to the unit:

- Make sure the volume is completely turned down.

2. Turn off the power on all connected devices.

3. Press the POWER switch on the rear panel of the DR-202 to turn the power off.

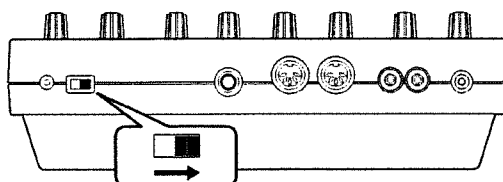

Let's Listen to a Demo Song

First, let's listen to a demo song (S20) that exhibits the DR-202's high-quality sounds and patterns.

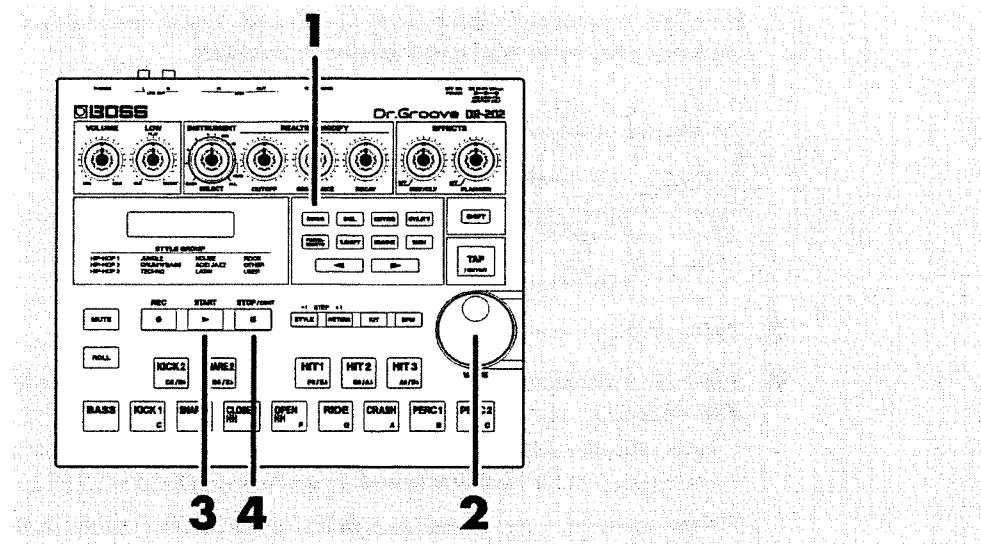

1. Press [SONG]. Confirm that the following appears in the display.

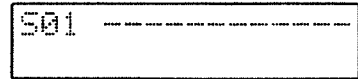

2. Rotate the VALUE dial to select the demo song (S20).

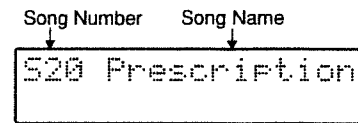

3. Press [START], and the demo song starts playing.

[START] flashes in time with the tempo (in BPM, or beats per minute) of the song.

"Prescription" Music by Vince LaDuca Copyright © 1998, Roland Corporation

4. When [STOP/CONT] is pressed, performance of the demo song is stopped.

- Note**
- All rights reserved. Unauthorized use of this material for purposes other than private, personal enjoyment is a violation of applicable laws.
 - No data for the music that is played will be output from MIDI OUT.

Demo Play

Demo Play plays all the preset patterns in sequence.

1. Press [STYLE] or [PATTERN].
2. Hold down [SHIFT] and press [START], the Demo Play starts playing.

```

** DEMO PLAY **
HIP-HOP 1    01
  
```

↑
Style Name

↑
Pattern Number

3. To advance to the succeeding patterns, rotate the VALUE Dial.
 4. To cancel Demo Play and return to the normal condition, press [STOP/CONT].
-

■ Composer Profile.....

Vince LaDuca (Twister)

Vince LaDuca is an engineer and dance music producer/artist from Los Angeles, California. He holds engineering credits from Motown Records, Ruthless Records, and Warner Brothers Records. In addition, he has written and produced 12-inch dance singles released on Uzziel Records—a label he started in 1995. Vince currently works as a Product Specialist for Roland Corp. U.S. He is also releasing singles on the Bassex/Black Licorice Record Label. Since touring with his mother's band at the age of 11, Vince has seen the evolution of electronic musical instruments and now he is proud to contribute with the DR-202. Enjoy!

How to Play Patterns

The DR-202 is equipped to offer 500 different patterns (400 Presets and 100 User patterns). Each pattern consists of several measures of musical material, using drum and bass sounds (and can also incorporate sounds from external MIDI devices).

These patterns are categorized into 12 different Style groups (see the lower part of the display).

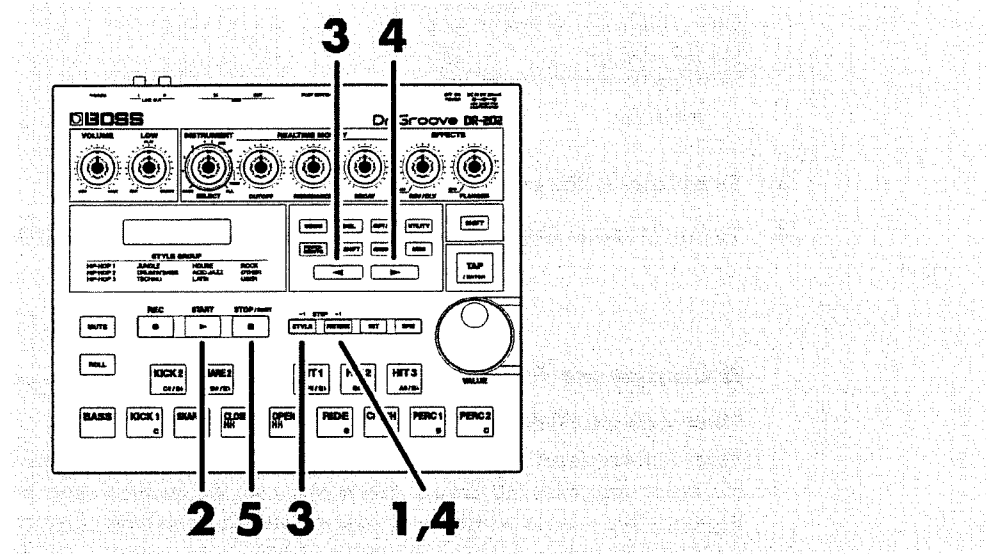

1. Press [PATTERN]. Confirm that the following appears in the display.

With Preset patterns:

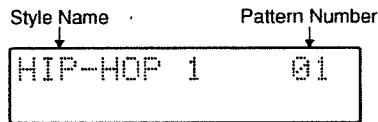

With User patterns:

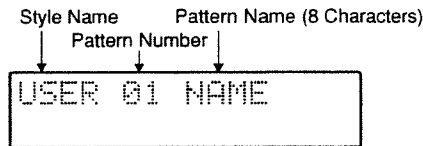

2. Press [START], and the pattern starts playing. [START] flashes in time with the pattern tempo.

* The User patterns were left empty when the unit was shipped from the factory.

3. By pressing [STYLE], or the [◀] cursor key to move the cursor to the left, you can use the VALUE dial to reserve a Style beforehand for performance.

When the pattern currently being played is played to the end, the performance automatically switches to the preselected pattern.

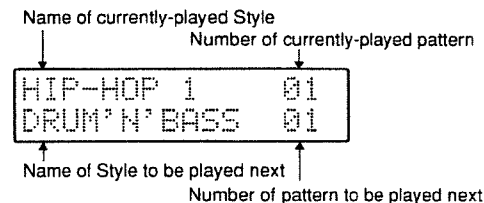

- By pressing [PATTERN] or the [▶] cursor key to move the cursor to the right, you can use the VALUE dial to preselect the patterns assigned to the current Style. When the pattern currently being played is played to the end, the preselected pattern is called up automatically.

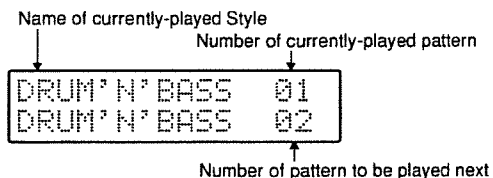

- Press [STOP/CONT] to stop play of the pattern.

How to Change Kits

You can select the tones for each of the instruments—kick drum, snare, and bass—used in the kit.

With the DR-202, the various selected instruments are grouped together and handled as drum kits.

You can specify which kit is to be used in each pattern, and naturally you can not only switch kits before you start playing, but during performances as well.

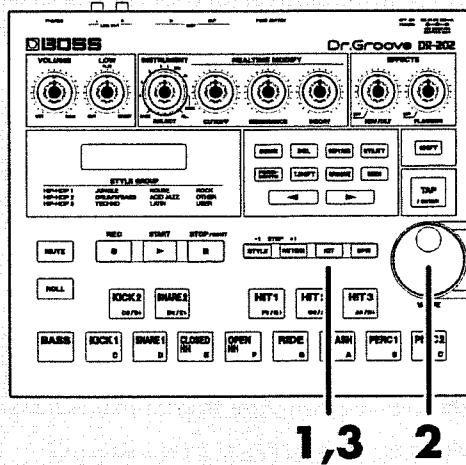

- Press [KIT]. Confirm that the following appears in the display.

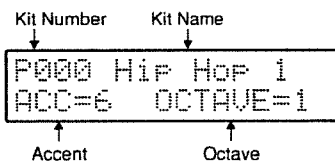

- Rotate the VALUE dial to select the kit. Kits can be switched anytime, even while a pattern is being played.
- Press [KIT]. The original screen reappears in the display.

Let's Turn the Dials to Change the Tone

You can change the tone with the knobs (except the VOLUME control) on the front panel of the unit.

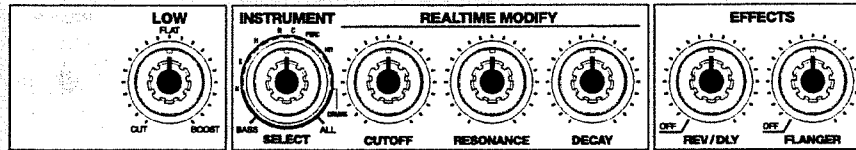

LOW: CUT-BOOST

This cuts or boosts the lower frequencies.

INSTRUMENT SELECT:

BASS, KICK 1, KICK 2, SNARE 1, SNARE 2, CLOSED HH, OPEN HH, RIDE, CRASH, PERC 1, PERC 2, HIT 1, HIT 2, HIT3, ALL DRUMS, ALL INST

The REALTIME MODIFY knob is rotated when specifying the desired instrument tone.

- * When ALL DRUMS is selected, then the tone for all drum parts may be changed.
- * When ALL INST is selected, the tone for drum parts and the bass part may be changed.

CUTOFF: -50--+50

This is used to adjust the resonance frequencies that are added to the sound. Rotating the knob to the left reduces the number of frequencies, making the sound more muffled. Turning the knob to the right increases the frequencies, creating a brighter tone.

- * With the knob set at the center position, the sound is unchanged.

RESONANCE: -50--+50

This is used to control the amount of resonance added to sound. The more the knob is turned to the right, the stronger the effect is.

- * With the knob set at the center position, the sound is unchanged.

DECAY: -50--+50

This is used to control the decay of the sound, or how long the sound continues before it becomes inaudible. Rotating the knob to the left creates a crisp sound with a lot of bite. Turning the knob to the right lengthens the amount of time the sound remains.

- * With the knob set at the center position, the sound is unchanged.

REV/DLY: 0-127

This adds reverberation to the sound. The more the knob is turned to the right, the greater the amount of reverb added.

- * The REV/DLY knob can be used to adjust either reverb or delay effects. These can be switched by changing the parameter settings (Refer to "Making Effect Settings," p.30).

FLANGER: 0-127

This adds a metallic-sounding undulation to the sound. This wavering effect increases as the knob is turned further to the right.

1. Rotate INSTRUMENT SELECT to choose the instrument whose tone you want to change.

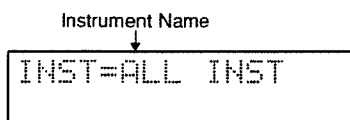

2. Rotate the knob to change the tone.

When any of the REALTIME MODIFY knobs (CUTOFF, RESONANCE, DECAY) or the EFFECTS knobs (REV/DLY, FLANGER) knobs are rotated, the corresponding value appears in the display.

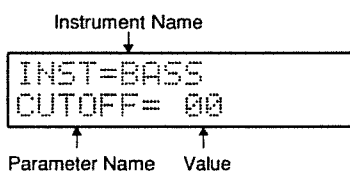

After a few moments, the previous screen appears in the display.

Let's Record a Pattern

You can record up to 100 different User patterns of your own. There are two ways to go about recording patterns.

- **Realtime Recording:** Recording is carried out as the material is performed.
- **Step Recording:** Each sound is input one at a time.

At this time, let's check out Realtime recording.

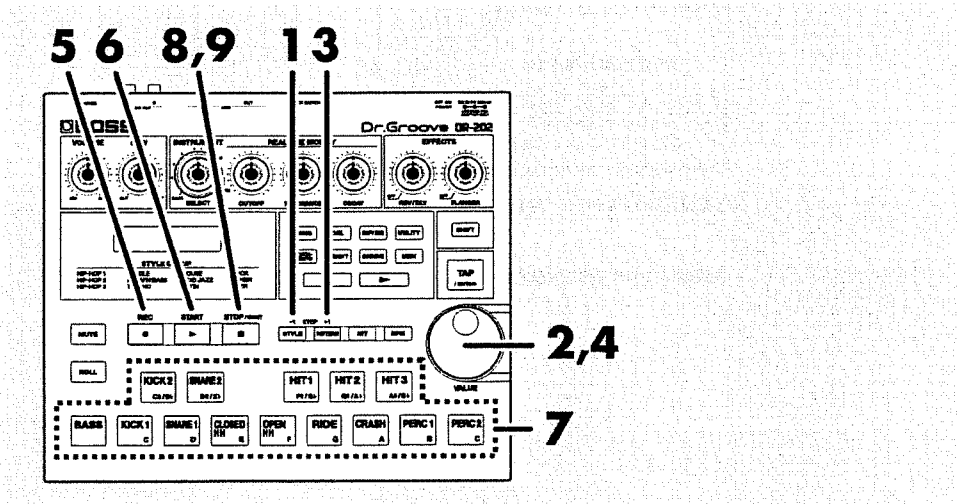

1. Press [STYLE]. Confirm that the following appears in the display.

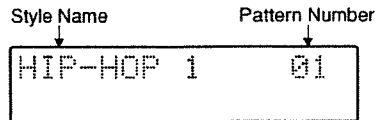

2. Rotate the VALUE dial to select the User Styles (USER).

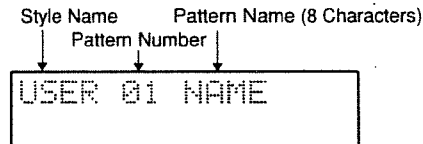

3. Press [PATTERN]. The cursor moves along under the pattern numbers.

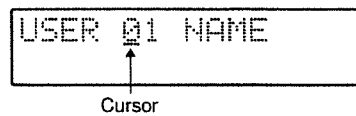

4. Rotate the VALUE dial to select the User pattern to be recorded.

5. Press [REC].

[REC] flashes, the metronome sound begins, and the unit is put in Realtime Recording standby mode.

* Press [BPM], you can change the tempo of the metronome as you wish.

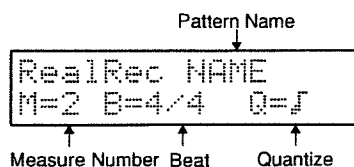
**6. Press [START].**

[REC] changes to steady illumination, [START] flashes in time with the rhythm of the song, and Realtime Recording begins.

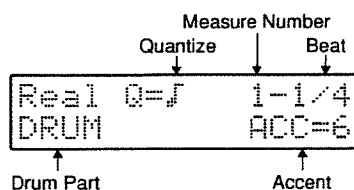
**7. Press the pad in time with the Metronome to record the sounds.**

To record the bass, press [BASS] so that [BASS].

Press [BASS] once more, and the [BASS] light goes out, returning you to drum recording.

8. Press [STOP/CONT].

The [REC] light resumes flashing and the [START] button light is extinguished, returning the unit to Realtime recording standby.

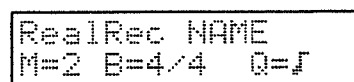
**9. Press [STOP/CONT].**

The [REC] light goes off, the metronome stops, and recording stops.

Let's Make a Song

A number of patterns, when arranged and played in sequence, is then called a song.
 A maximum of 999 separate patterns can be recorded as one song.
 Now let's actually record some patterns to create a song (Song Recording).

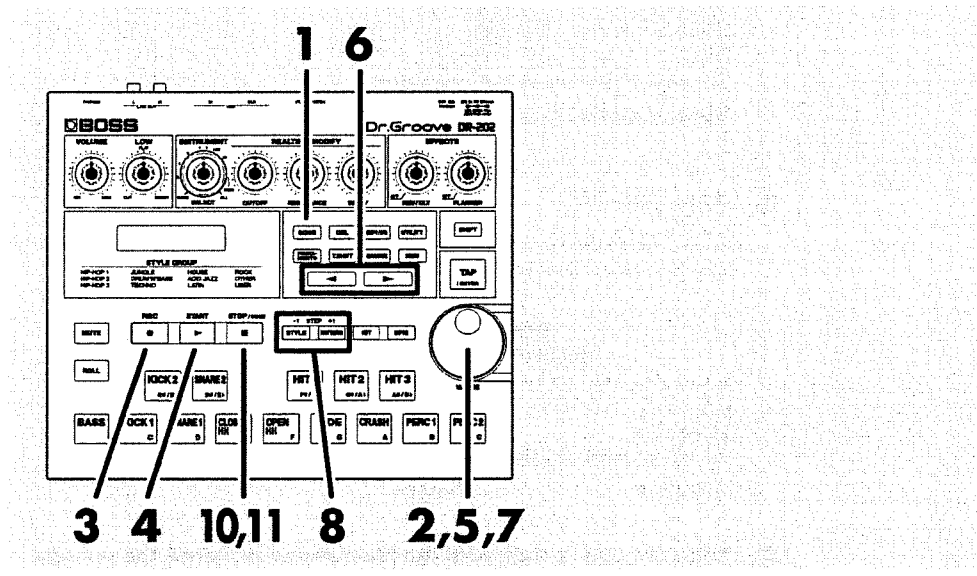

1. Press [SONG].
 Confirm that the following appears in the display.

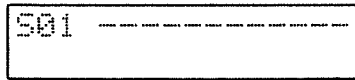

2. Rotate the VALUE dial to select the User Song to be used for recording.
 * Song S20 is the demo song. This song cannot be used for recording.

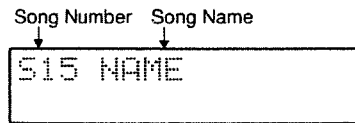

3. Press [REC].
 [REC] flashes, and the unit is put in Song Recording standby mode.

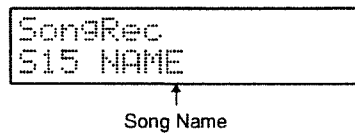

4. Press [START].
[REC] changes to steady illumination.

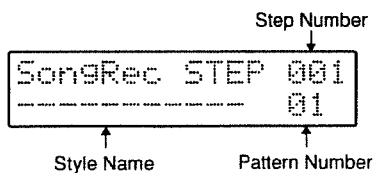

5. Rotate the VALUE dial to select the Style.
6. When a Style has been selected, press the [▶] cursor key to move through the pattern numbers.
7. Rotate the VALUE dial to select the pattern.
8. When the Style and pattern have been selected, press [STEP -1/+1] ([STYLE], [PATTERN]) to continue to the next pattern.
9. Repeat Steps 5 and 8 until the song is completed.
10. When you have finished entering the patterns, press [STOP/CONT].
[REC] starts flashing again, and the unit is returned to Song Recording standby mode.

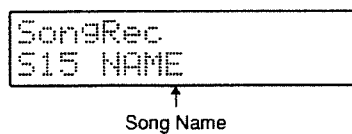

11. Press [STOP/CONT].
The [REC] light goes off, and the song is returned to playback mode.

Restoring the Original Factory Settings (Factory Reset)

Carry out the Factory Reset procedure to restore the tone settings, pattern parameters, and other settings to the conditions at the time your DR-202 was shipped from the factory. You can have all settings reset to their original state, or elect to reset only the sequencer settings, the drum kit, or the system settings.

Factory Settings

Kit

Contents of the User Kits are the same as Nos. 0–63 of the Preset Kits.

Patterns

User Patterns are cleared.

Song

User Songs are cleared.

UTILITY

LCD CONTRAST		5
FOOT SWITCH ASSIGN	Foot switch assign	StartStop
Strong Beat INST	Strong Beat Instrument	Drystk (134)
Weak Beat INST	Weak Beat Instrument	909RIM (130)
Strong Beat LEVEL		10
Weak Beat LEVEL		6

MIDI

CHANNEL DRUM	MIDI Channel (Drum Part)	10
CHANNEL BASS	MIDI Channel (Bass Part)	2
CHANNEL EXT	MIDI Channel (External Part)	1
PROG CHG SW	MIDI Program Change Switch	ON
VOLUME SW	MIDI Volume Switch	ON
VOLUME DRUM	MIDI Volume (Drum Part)	127
VOLUME BASS	MIDI Volume (Drum Part)	127
VOLUME EXT	MIDI Volume (External Part)	127
EXPRESSION SW	MIDI Expression Switch	ON
CONTROL CHG SW	MIDI Control Change Switch	ON
THRU SW	MIDI Thru Switch	OFF
OUT ASSIGN DRUM	Output Assign (Drum Part)	INT
OUT ASSIGN BASS	Output Assign (Bass Part)	INT
SYNC MODE	Synchro Mode	AUTO
SYS EXCLUS	System Exclusive ID Number	17

* When Factory Reset is carried out, the data saved in the DR-202 is cleared. If you have saved important data that you want to preserve, then use the Bulk Dump procedure (p.60) to save the data to an external recording device (such as a sequencer) before carrying out Factory Reset.

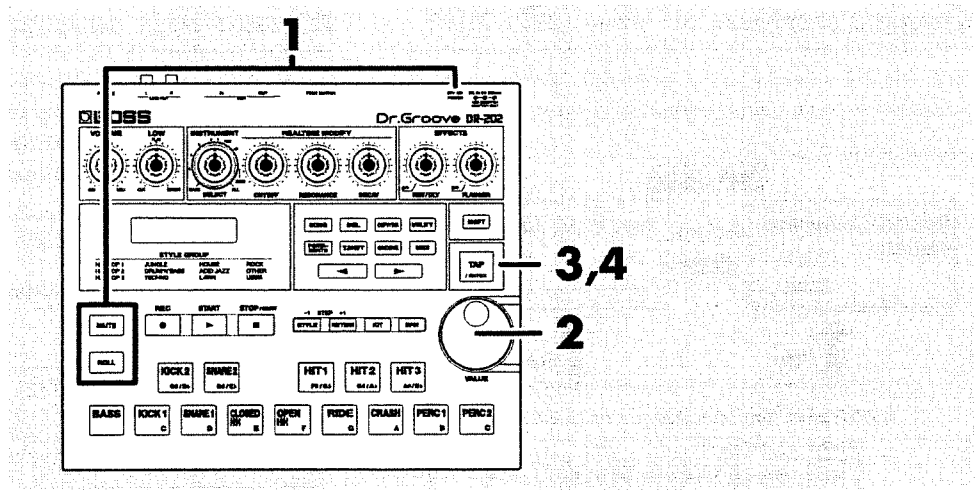

1. While pressing [MUTE] and [ROLL], turn the DR-202's POWER switch to OFF. Confirm that the following appears in the display.
Continue holding down [MUTE] and [ROLL] until the following appears in the display.

```
Factory Reset
Mode=All
```

↑ Shows that DR-202's factory settings are being restored

2. Rotate the VALUE dial to select the settings you wish to have reset. You can select from the four groups shown below.
 - All: All internal settings are restored to original factory conditions.
 - SongPattern: Songs and patterns are restored to their original conditions.
 - * The contents of all User patterns and User songs will be erased.
 - Kit: The kit is restored to its original conditions.
 - UtilityMIDI: The UTILITY and MIDI settings are restored to their original conditions.

3. When you have selected the settings to be reset, press [TAP/ENTER].
4. To carry out Factory Reset, press [TAP/ENTER] once more.

Factory Reset is opened, and a screen showing the progress of the procedure appears in the display.

If you press the [▶] cursor key to move the cursor to "No" and press [TAP/ENTER], the screen that normally appears when the power is switched on is then displayed, without Factory Reset being performed.

```
Are You Sure?
Yes No
```

5. When Factory Reset is finished, the screen normally appearing when the power is switched on returns automatically.

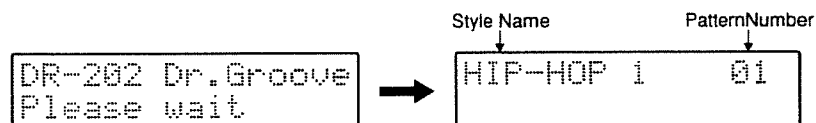

Chapter 1 Overview of the DR-202

Organization of the DR-202

The DR-202 consists of a controller section, sound generator section, and a sequencer section.

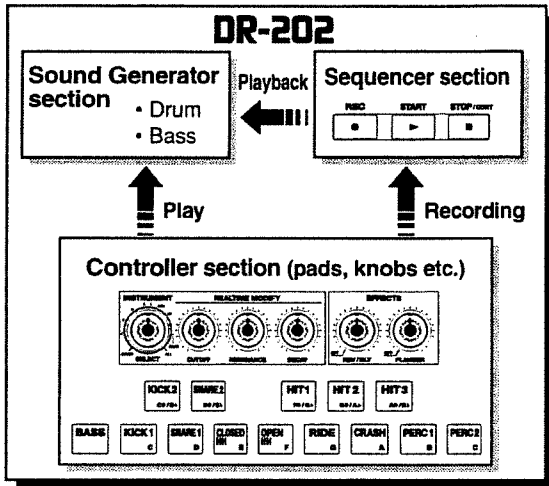

Overview of the DR-202

Controllers

The controllers include the pads, knobs, the pedal switch that can be connected to the rear panel, and other features. By operation of these controllers, you can create sounds and make changes to them.

Sound Generator

The sound generator is the part of the device that produces sound. Sounds are produced according to information coming from the DR-202's controller and sequencer. In addition, the sound generator can also produce sound according to MIDI messages sent from external MIDI devices.

Sequencer

The sequencer records controller operations (knob movements) as MIDI messages, and plays back such recorded MIDI messages. Furthermore, by sending MIDI messages recorded by the sequencer out via the MIDI OUT connector, you can also control external MIDI devices such as Roland's SP-202 and MS-1.

* *MIDI (Musical Instrument Digital Interface) is a standard protocol for the exchange of performance and other information between electronic instruments and computers. Data can be sent and received by devices equipped with MIDI connectors when such devices are connected by MIDI cables.*

About the Sound Generator

In performing operations to make sounds with the sound generator and make changes to the tones, the DR-202's sound generator divides sounds into three types of sound units (instruments, parts, and kits).

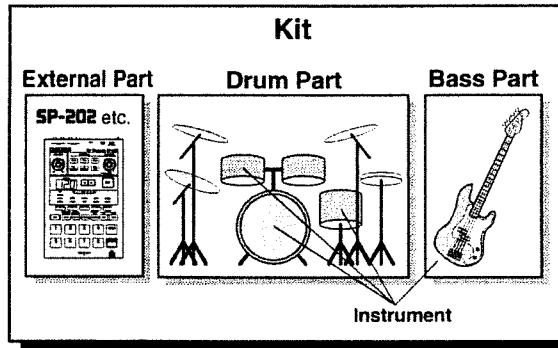

Instruments

Instruments are the sounds produced by the unit, such as the bass (kick) drum, snare drum, and other percussive sounds—and the bass.

The DR-202 features 256 different internal instrument sounds.

Parts (Performers)

Parts refers to the "performers" playing specified instruments.

The DR-202 operates with three parts: drums, bass, and external. Thirteen drum and percussion instruments are assigned to the drum parts.

* *Instruments cannot be assigned to the external parts. Rather, the connected external MIDI device itself is treated as the instrument.*

Kits (Bands)

The kit is the combination of the three parts—drums, bass, and external parts—which are designated as a "band."

The DR-202 includes both prearranged, preset kits, and user kits the settings of which you can change as you wish.

When performing, you can get a variety of different tones by switching these kits.

About maximum simultaneous polyphony

The DR-202 is able to play up to 24 notes (voices) simultaneously. If the incoming musical data requests more than 24 notes simultaneously, some notes will drop out. Be careful not to exceed the maximum simultaneous polyphony.

The number of notes that can be sounded will actually depend not only on the number of notes being played, but also on the number of voices that are used by each instrument.

For example, if you are playing an instrument that uses two voices, that instrument will take up two times the number of notes that are played.

* About the number of voices each instrument uses, refer to "Instrument List" on p.70.

About the Sequencer

The two types of units used in performing with the DR-202's sequencer are the patterns group into the various Styles and songs that combine these patterns in sequence.

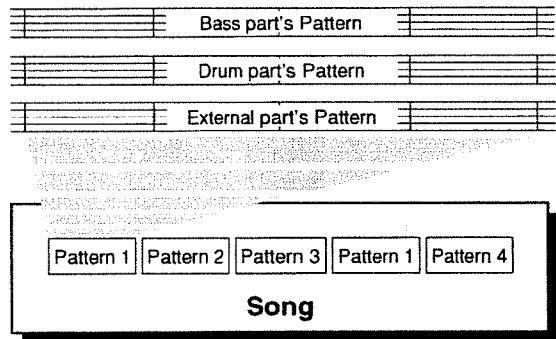

Patterns

The pattern is the smallest unit performed by the sequencer.

The DR-202 performs songs by switching from one pattern to the next.

There are two ways to compose patterns: Realtime Recording and Step Recording.

In Realtime Recording, patterns are entered by striking or tapping the pad in time with the metronome.

With Step Recording, the timing, pitch, and other features of the sounds played by each instrument are designated one at a time.

Pattern Setup Information

Each pattern contains the following setup information.

Kit

This designates the kit used in the pattern. This is set by pressing [KIT].

Standard Tempo (BPM) Information

This specifies the tempo at which the pattern is played.

This is set by pressing [BPM] or by tapping [TAP/ENTER].

Roll Information

This specifies the roll type and speed used in rolls that are played. Press [ROLL] to make this setting.

Mute Information

This setting determines whether the mute for each instrument is to be on or off.

Press [MUTE] to make this setting.

* This setup information cannot be switched within a single pattern.

Styles

Patterns are classified as belonging to either Hip-Hop or Techno Styles.

When deciding which pattern to use, you can narrow your selection by first selecting the style.

- HIP-HOP 1
- HIP-HOP 2
- HIP-HOP 3
- JUNGLE
- DRUM'N'BASS
- TECHNO
- HOUSE
- ACID JAZZ
- LATIN
- ROCK
- OTHER
- USER

Songs

A song is a number of patterns arranged and played in sequence. A maximum of 999 separate patterns can be recorded in any one song.

* Song S20 is the demo song. This song cannot be used for recording.

Organization of Modes

The DR-202 has numerous functions for creating patterns and songs as well as for editing tones. These functions are organized into the following four modes.

Song Mode

Press [SONG] to put the DR-202 in Song mode. The creation, editing, and performance of songs takes place in Song mode.

```
S01 NAME
```

Pattern Mode

This mode is called up when the power is turned on, and by pressing [STYLE] or [PATTERN]. The creation, editing, and performance of patterns takes place in Pattern mode.

With Preset patterns:

Style Name	Pattern Number
↓	↓
HIP-HOP 1 01	

With User patterns:

Style Name	Pattern Name (8 Characters)
↓	↓
Pattern Number	
↓	
USER 01 NAME	

MIDI Mode

Press [MIDI] to put the DR-202 into MIDI mode. When using external MIDI devices, you can make MIDI-related settings in MIDI mode.

* Even if you press [MIDI], you cannot switch to MIDI mode while a performance is in progress.

```
MIDI CHANNEL
DRUM=10
```

Utility Mode

Press [UTILITY] to put the DR-202 into Utility mode. This mode is used for making LCD screen contrast, footswitch, and metronome settings, and for checking remaining memory (or how many more songs or patterns can still be recorded).

```
UTILITY
LCD CONTRAST=5
```

Chapter 2 Performing Patterns and Songs

Performing Patterns

Performance of Patterns

1. Press [STYLE] or [PATTERN]. The Pattern Mode screen appears in the display.

With Preset patterns:

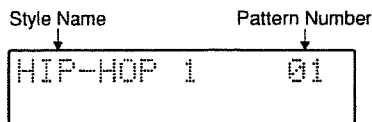

With User patterns:

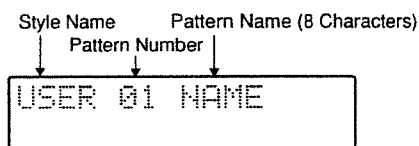

2. Press [STYLE] or the [◀] cursor key to move the cursor to the Style names, then rotate the VALUE dial to select a Style.
3. Press [PATTERN] or the [▶] cursor key to move the cursor to the pattern names, and rotate the VALUE dial to select a pattern.
4. Press [START] to start the selected pattern playing. [START] flashes in time with the pattern tempo.

Changing Patterns

You can freely change patterns, even while they are being played.

1. Press [STYLE] or [PATTERN] to place the cursor at the desired Style name and pattern number.
2. Rotate the VALUE dial so that the upcoming selected pattern's Style name and pattern appear in the lower row of the display.

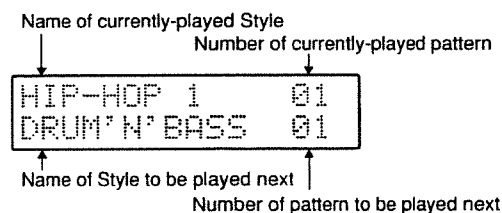

3. Continuing from the current pattern, performance of the preselected pattern then begins.

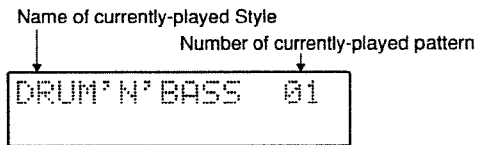

Stopping the Pattern

1. Press [STOP/CONT] to stop the performance of the pattern. At this time, preselection of the next pattern due to be played is canceled.
 2. If [STOP/CONT] is pressed once more, performance of the pattern begins from the point where it was stopped.
- * If [START] is pressed, then performance begins from the start of the selected pattern.
 - * If the pattern is stopped while a roll is being played, then even when [STOP/CONT] is pressed to resume performance of the pattern, that roll is not played.
 - * Patterns cannot be played in MIDI mode.

Performing Songs

Performance of Songs

1. Press [SONG]. The Song Mode screen appears in the display.

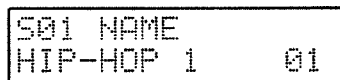

2. Rotate the VALUE dial to select the song number.
- * The demo song has been stored in Song S20.
3. Press [START] to begin performance of the song. [START] flashes in time with the tempo.
- * Songs cannot be switched during performance.
 - * When the song starts playing, the pattern of the step currently being played is shown on the lower line of the display.

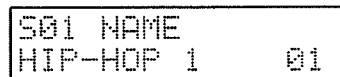

- * If [START] is pressed, then performance begins from the start of the currently selected song.
- * If the song is stopped while a roll is being played, then even when [STOP/CONT] is pressed to resume performance of the song, that roll is not played.
- * Songs cannot be played in MIDI mode.

Stopping the Song

1. Press [STOP/CONT] to stop the performance of the song.
2. If [STOP/CONT] is pressed once more, performance of the song begins from the point where it was stopped.

Playing from the Middle of a Song

1. Pressing the [▶] cursor key will cause the display to show the current step on the upper line.
2. To shift the steps, rotate the VALUE dial or press [STEP-1/+1] ([STYLE], [PATTERN]).

You can shift the steps by 10, if you hold down [SHIFT] while pressing [STEP -1/+1] ([STYLE], [PATTERN])

* While playing a song, you cannot shift steps.

3. Pressing [START] again to resume playing from the step you have shifted to.

```
STEP 012
HIP-HOP 1 01
```

3. Pressing the [◀] cursor key returns you to the Song Selection screen.

Changing the Tempo (BPM)

You can freely change the tempo at any time, even while a pattern or song is playing.

- * BPM value which appears on the display always describes the tempo of the DR-202.
- * BPM stands for "beats per minute," that is, the number of quarter notes played per minute.

Changing the Tempo with the VALUE Dial

1. Press [BPM]. The tempo appears in the display. The way the tempo is displayed differs with the performance method.

Pattern Mode:
When performing at a fixed tempo (regardless of pattern)

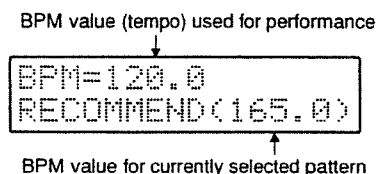

Pattern Mode:
When performing at the BPM (standard tempo) set for each pattern

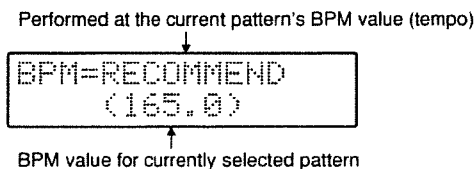

Song Mode:
Use this mode to play at a fixed BPM (standard tempo), no matter what pattern is selected

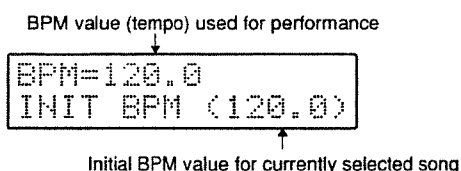

Song Mode:
Use this mode to play at the BPM (standard tempo) set for each pattern

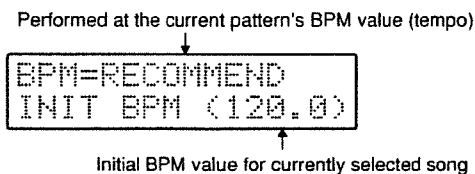

2. Rotate the VALUE dial to change the tempo (from 40.0 to 250.0 BPM). Tempos are adjustable in increments of 0.1 BPM. When [SHIFT] is held down while the VALUE dial is rotated, the tempo changes in increments of 1 BPM.

Standard Tempo (BPM=RECOMMEND)

The most suitable tempo is preset in each of the patterns (pattern Setup information). This is referred to as the "standard tempo."

Pressing the [▶] cursor key after pressing [BPM] sets the DR-202 to BPM=RECOMMEND, which then causes each pattern to be played at its standard tempo.

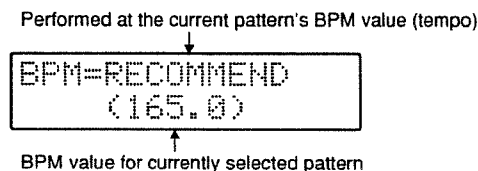

Pressing the [◀] cursor key restores the original tempo.

Changing the Tempo by Tapping the Button (Tap Tempo)

You can also change the tempo according to the rate at which you tap [TAP/ENTER].

1. Tap [TAP/ENTER] four times at the tempo you want to change to. The tempo is calculated automatically, and the pattern adopts the new tempo that corresponds to the timing of the strikes. The tempo then appears in the display.

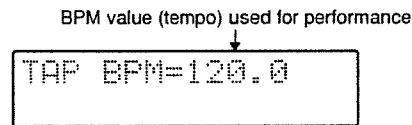

- * The tempo cannot be changed if the rate at which [TAP/ENTER] is tapped falls outside the range of 40.0–250.0 BPM.

Changing the Kit

Sometimes, you will want to change the kit used to play a pattern. To change the kit, perform the steps below.

1. Press [KIT].
The name and number of the kit used in the currently selected pattern appear in the display.

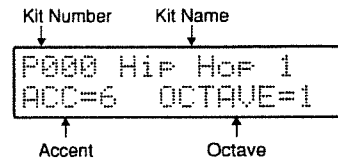

2. Rotate the VALUE dial to change the kit.
3. Press [KIT].
The original screen reappears in the display.

Modifying a tone in real time using the control knobs (Realtime Modify)

1. Rotate the INSTRUMENT SELECT knob to select the instrument whose tone you want to change.
- * Selecting ALL DRUMS allows you to change the tone of all of the drum parts.
 - * Selecting ALL INST allows you to change the tone of the bass part as well as all of the drum parts.

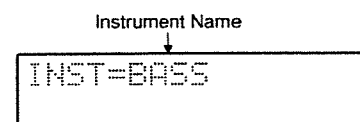

2. Rotate the REALTIME MODIFY knobs (CUTOFF, RESONANCE, DECAY) to change the tone.

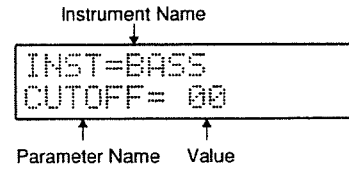

- * The content of changed settings are deleted when kits are switched or if the power is cut. If you wish to save the data, press [KIT] until you have the currently selected kit displayed, then press [COPY/INST] to write the data (this applies only to User Kits). (Refer to "Copying a Kit" on p.56)

CUTOFF: -50+50

This control adjusts the cutoff. With larger values (increasing the cutoff), most of the overtone components are included, making a harder (brighter) sound, whereas lowering the value (reducing the cutoff) cuts out most of the overtones and makes the sound more muffled (darker).

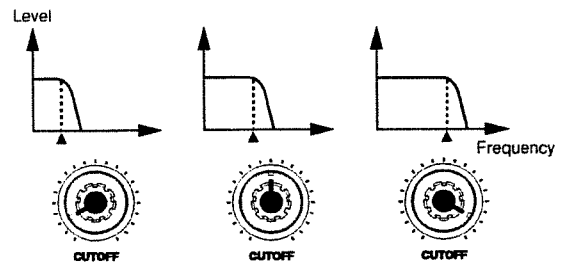
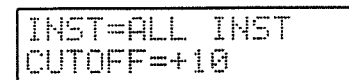

RESONANCE: -50+50

This is used to control the amount of resonance added to sound. The larger the value, the more the effect is emphasized, creating a sound with a stronger resonance.

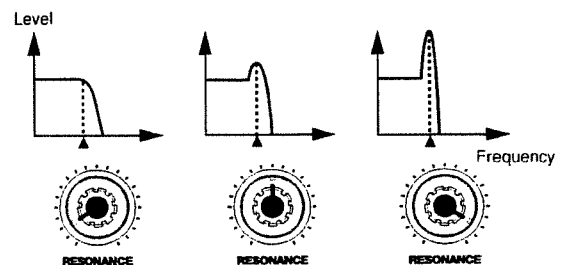
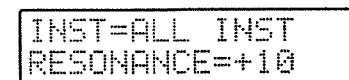

DECAY: -50-+50

This control adjusts the decay time. The larger the value, the longer the decay lasts.

```
INST=ALL INST
DECAY=-03
```

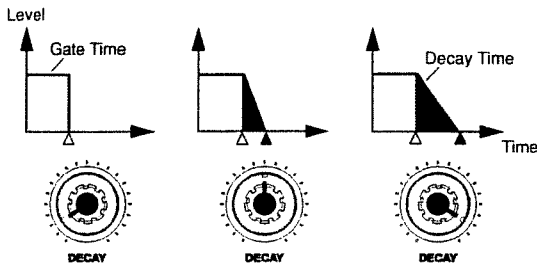

REV/DLY (DELAY FEEDBACK): 0-127

The amount of delay feedback is adjusted when DELAY is selected with the REV/DLY TYPE.

```
DELAY
FEEDBACK=64
```

FLANGER (FLANGER E.LEVEL): 0-127

This adjusts the FLANGER effect level.

```
FLANGER
E.LEVEL=64
```

Adding Effects

The DR-202 features two kinds of internal effects systems: reverb/delay and flanger.

1. Rotating the EFFECTS knobs (REV/DLY, FLANGER) turns each of the effects on and off and adjusts the effect amount. In addition, adjusted parameters are shown in the display screen.

```
Effect Name
↓
REVERB
E.LEVEL=64
↑      ↑
Parameter Name  Value
```

* The content of changed settings are deleted when kits are switched or if the power is cut. If you wish to save the data, press [KIT] until you have the currently selected kit displayed, then press [COPY/INST] to write the data (this applies only to User Kits). (Refer to "Copying a Kit" on p.56)

REV/DLY (REVERB E.LEVEL): 0-127

The reverb effect level can be adjusted when REVERB is selected with the REV/DLY TYPE.

```
REVERB
E.LEVEL=64
```

Making Effect Settings

There are a number of parameters for each effect besides those whose settings can be adjusted with the EFFECTS knobs (REV/DLY, FLANGER). By making changes to these other settings, you can achieve an even broader palette of effects.

1. Rotate an EFFECTS knob (REV/DLY, FLANGER). The parameter to be adjusted appears in the display.

```
Effect Name
↓
REVERB
E.LEVEL=64
↑      ↑
Parameter Name  Value
```

After a moment, the previous screen returns.

2. Press the [▶] cursor key while the parameter appears in the display to select the parameter you want.

```
REVERB
TYPE=Small Room
↑      ↑
Parameter Name  Value
```

3. Rotate the VALUE dial to set the parameter.

The content of changed settings are deleted when kits are switched or if the power is cut. If you wish to save the data, press [KIT] until you have the currently selected kit displayed, then press [COPY/INST] to write the data (this applies only to User Kits). (Refer to "Copying a Kit" on p.56)

REVERB/DELAY TYPE:

Small Room, Studio, Club, Lounge, Large Hall, Dark Hall, Plate 1, Plate 2, Stereo Delay, Pan Delay

This switches the type of reverb or delay used for the sound. Selecting any of the effects Small Room—Dark Hall results in a reverb effect, whereas selecting Stereo Delay or Pan Delay gives delay effects.

- **Small Room:** Gives the reverb found in smaller rooms.
- **Studio:** Gives the reverb found in studios.
- **Club:** Gives the reverb found in clubs.
- **Lounge:** Gives the reverb found in lounges.
- **Large Hall:** Gives the reverb found in larger halls.
- **Dark Hall:** Adds the darker reverberation found in halls.
- **Plate 1:** Gives a plate reverb.
- **Plate 2:** Gives a plate reverb.
- **Stereo Delay:** The same delay sound is added to the left and right sides.
- **Pan Delay:** The delay sound is panned across the left and right sides.

REVERB TIME: 0–100

This sets the length of the reverberation when REVERB is selected.

DELAY TIME:

5–450 ms, (♩♩♩) half-note triplets, (♩.) dotted quarter notes, (♩) quarter notes, (♩♩♩) quarter-note triplets, (♩.) dotted eighth notes, (♩) eighth notes, (♩♩♩) eighth-note triplets, (♩.) dotted sixteenth notes, (♩) sixteenth notes, (♩♩♩) sixteenth-note triplets

This sets the delay time when DELAY is selected.

- * *Delay time does not synchronize with external MIDI clock.*
- * *If tempos do not fall within the ranges listed below, the delay is set to 450 ms, regardless of tempo.*
- (♩♩♩) Half-note triplets : BPM=177.0–250.0
- (♩.) Dotted quarter notes : BPM=200.0–250.0
- (♩) Quarter notes : BPM=133.0–250.0
- (♩♩♩) Quarter-note triplets : BPM= 89.0–250.0
- (♩.) Dotted eighth notes : BPM=100.0–250.0
- (♩) Eighth notes : BPM= 67.0–250.0
- (♩♩♩) Eighth-note triplets : BPM= 45.0–250.0
- (♩.) Dotted sixteenth notes : BPM= 50.0–250.0
- (♩) Sixteenth notes : BPM= 40.0–250.0
- (♩♩♩) Sixteenth-note triplets : BPM= 40.0–250.0

DELAY E.LEVEL: 0–100

This sets the delay volume when DELAY is selected.

FLANGER TYPE:

Jet Flanger, Soft Flanger, Hard Flanger, Cold Flanger

This selects the type of flanger.

- **Jet Flanger:** A flanger effect that sounds like a jet engine.
- **Soft Flanger:** A gentle flanger effect.
- **Hard Flanger:** A strong flanger effect.
- **Cold Flanger:** A chorus-like flanger effect.

FLANGER RATE: 0–100

This is for selecting the flanger rate.

Muting for Each Instrument

You can mute instruments individually with the Mute function.

1. Press [MUTE].

[MUTE] is illuminated, and the mute status appears in the display. Instrument names are expressed alphanumeric characters in the upper line of the display.

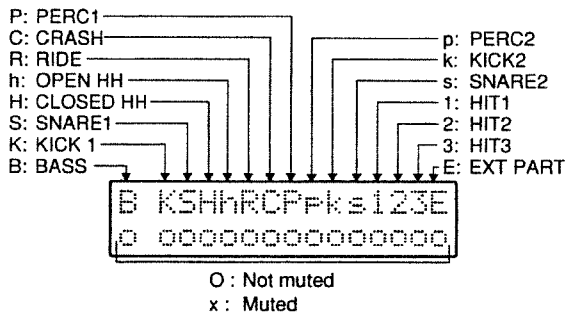

Performing Patterns and Songs

2. Pressing a pad switches the mute status for the instrument assigned to that pad.

o: Not muted
x: Muted

* To switch the mute status for external parts, press [MIDI].

3. The display returns to the previous screen when [MUTE] is pressed. In this case, [MUTE] flashes if any instruments are muted.

* The mute is not effective if the muted instrument is not used in the pattern.

Solo Function

If [SHIFT] is held down while a pad is pressed, all instruments except for the one on that pad are muted (Solo function). Pressing the same pad while [SHIFT] is again held down returns the instrument to its previous mute status.

All Mute Lift Function

Pressing [MUTE] while [SHIFT] is held removes all mutes.

Chapter 3 Performing with the Pads

The DR-202 is equipped with 13 key-type pads. With these pads, you can play songs using drums, bass, and sounds from external MIDI sound generators. The pads can be used for performing in all modes (Song, Pattern, MIDI, and Utility).

Playing Drums

When the power is switched on, the DR-202 is ready to play drum sounds.

If drum sounds cannot be produced even when the pads are tapped, then be sure to check the following points.

- Check to see if [BASS] is illuminated. If it is either illuminated or flashing, press [BASS] to turn it off.
- Check to see if [MUTE] is illuminated. If [MUTE] is indeed illuminated, press to turn it off.
- Check to see if [ROLL] is illuminated. If it is either illuminated or flashing, press [ROLL] to turn it off.

Changing the Accent (Volume)

1. Press [KIT].
The kit appears in the display.

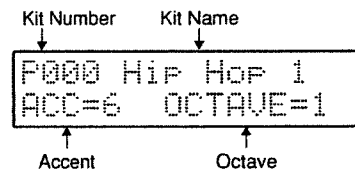

2. Press the [▶] cursor key to move the cursor to the accent.
3. Rotate the VALUE dial to adjust the accent (values from 1 to 8).
4. Press [KIT].
The previous screen returns to the display.

Performing with Rolls

The DR-202's Roll function lets you play ultra-fast "drum'n'bass" style rolls with the tap of a single pad. 68 different user-set roll types and roll speeds provide you with a wide variety of performance options.

- * Rolls cannot be played with the bass sounds or sounds from an external MIDI sound generator.
- * If roll settings are changed during the performance of a pattern (or song), the drums played in that pattern (or song) are performed with those newer settings.

1. Press [ROLL].
[ROLL] is illuminated, and the roll type appears in the display.

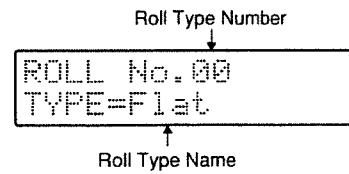

2. When the pad is struck, the roll is played.
3. To return to normal play, press [ROLL] once more.
The illumination of [ROLL] is turned off, and the previous screen is reappears in the display.

Changing the Roll Type

1. Press [ROLL].
[ROLL] is illuminated, and the roll type appears in the display.

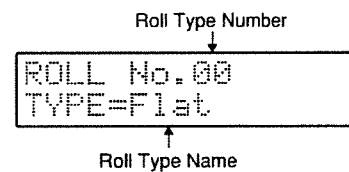

2. Rotate the VALUE dial to change the roll type.

No.0	Flat	No.17	Down Alt
No.1	Cresc	No.18-20	Down Dir1-3
No.2	Decresc	No.21-23	Lo-Fi1-3
No.3	Up	No.24-26	Hi-Fi1-3
No.4	Down	No.27-29	Lo-Fi1-3 Alt
No.5	Up Cresc	No.30-32	Lo-Fi1-3 Dir1
No.6	Down Cresc	No.33-35	Lo-Fi1-3 Dir2
No.7	Flat Dir	No.36-38	Hi-Fi1-3 Alt
No.8	Cresc Alt	No.39-41	Hi-Fi1-3 Dir1
No.9-10	Cresc Dir1-2	No.42-44	Hi-Fi1-3 Dir2
No.11	Decresc Alt	No.45-56	Phrase1-12 Dir
No.12	Decresc Dir	No.57-64	Fill1-8
No.13	Up Alt	No.65-67	Flam1-3
No.14-16	Up Dir1-3		

Changing the Roll Speed

1. Press [ROLL]. [ROLL] is illuminated, and the roll type appears in the display.

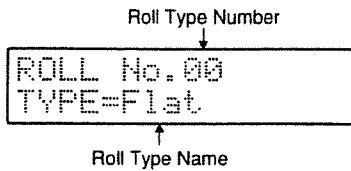

2. When the [▶] cursor key is pressed, the roll speed is displayed in the screen.

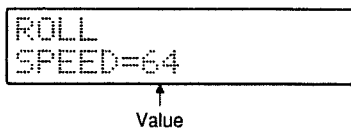

3. Rotate the VALUE dial to change the roll speed (00–127).
 - * Roll speed is unrelated to the tempo.
4. Pressing the [◀] cursor key returns you to the Roll Type Selection screen.

Holding Rolls

You can have rolls continue to play (hold) even after releasing the pads by pressing [ROLL] while rolls are played (while the pads are pressed).

- * The [ROLL] contains to flash in tempo with the roll speed, while rolls are being held.
- * When the selected roll type is something other than loop playback, the sound stops when the roll is finished.
- * When a looped roll is selected for the roll type, the roll continues to play. Press [ROLL] once more, illuminating [ROLL], to stop the roll.

Performing with the Pads

About Rolls

Although a Note Number is assigned to each of the 13 sounds (KICK1, SNARE1, etc.) that make up the drum parts, other Note Numbers, different than those for the 13 regular sounds, are assigned for use with roll sounds (To have an external MIDI device perform DR-202 rolls, specify a Note Number to be assigned to any such rolls).

Pad	Note Number
KICK 1	36 (24H)
KICK 2	35 (23H)
SNARE 1	38 (26H)
SNARE 2	40 (28H)
CLOSED HH	42 (2AH)
OPEN HH	46 (2EH)
HIT 1	50 (32H)
RIDE	51 (33H)
HIT 2	47 (2FH)
CRASH	49 (31H)
HIT 3	43 (2BH)
PERC 1	60 (3CH)
PERC 2	61 (3DH)

Pad	Note Number
ROLL KICK 1	100 (64H)
ROLL KICK 2	101 (65H)
ROLL SNARE 1	102 (66H)
ROLL SNARE 2	103 (67H)
ROLL CLOSED HH	104 (68H)
ROLL OPEN HH	105 (69H)
ROLL HIT 1	106 (6AH)
ROLL RIDE	107 (6BH)
ROLL HIT 2	108 (6CH)
ROLL CRASH	109 (6DH)
ROLL HIT 3	110 (6EH)
ROLL PERC 1	111 (6FH)
ROLL PERC 2	112 (70H)

When a roll is performed by the DR-202, it is not interpreted as “here is performance data representing a string of separate strikes played one by one,” but rather “here is a single tone called a ‘roll.’” Thus, in patterns that include rolls, if you stop the roll before it has finished playing, and then try to resume playback of the roll from the point where it was stopped, this cannot be done (this also applies to sounds with long gate times when they are stopped in progress).

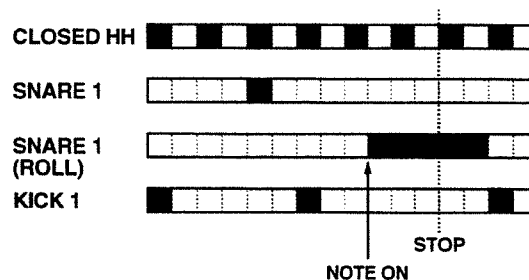

Note On messages reside at the left of the black part of the scroll, while the black part shows the gate time. If you stop at the position of “STOP,” then resume play, no sound will be heard, since there is no Note On message in SNARE 1 (ROLL). Only CLOSED HH will be heard.

Performing with Bass Sounds

When the power is switched on, the DR-202 is ready to play drum sounds.

To play bass sounds, press [BASS]; [BASS] is then illuminated.

If bass sounds cannot be produced even when the pads are tapped, then be sure to check the following points.

- Check to see if [BASS] is illuminated. If it is not illuminated, press [BASS] once; if it is flashing, press [BASS] twice so that the illumination is constant.
- Check to see if [MUTE] is off. If [MUTE] is illuminated, press to turn it off.
- Check to see if [ROLL] is off. If it is either illuminated or flashing, press [ROLL] to turn it off.

Changing the Accent (Volume)

1. Press [KIT].
The kit appears in the display.

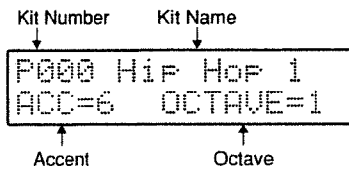

2. Press the [▶] cursor key to move the cursor to the accent.
3. Rotate the VALUE dial to adjust the accent (values from 1 to 8).
4. Press [KIT]. The previous screen returns to the display.

Shifting Pad Pitches by Octaves (Octave Shift)

When performing with bass sounds and sounds from an external MIDI sound generator, you can shift within a range of up to eight octaves with the Octave Shift settings.

- * *Octave Shift cannot be set when using drum sounds.*
- * *Pad key placements for drum sounds are unrelated to MIDI Note Numbers.*

1. Press [KIT].
The kit appears in the display.

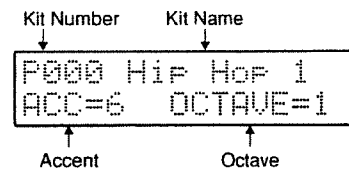

2. Press the [▶] cursor key to move the cursor to OCTAVE.
3. Rotate the VALUE dial to set the Octave Shift (from 0 to 7).
4. Press [KIT]. The previous screen returns to the display.

Setting the Portamento

Portamento is a function that makes pitch changes “glide” between one note and the next. When playing bass sounds, you can turn the portamento on and off as well as set the time it takes the pitch to change.

- * *The portamento function is not operable with drum sounds.*

1. Press [PORTAMENTO].
The portamento on/off status and portamento time are displayed on the screen.



2. Press the [▶] cursor key to move the cursor to portamento on/off or portamento time (00–127)
3. Rotate the VALUE dial to make the settings.

Performing with an External MIDI Sound Module

When the power is switched on, the DR-202 is ready to play drum sounds.

To play sounds from an external MIDI sound Module, hold down [SHIFT] while pressing [BASS]; [BASS] then flashes.

If sounds from the external MIDI sound Module cannot be produced even when the pads are tapped, then be sure to check the following.

- Check to see if [BASS] is flashing. If it is either off or illuminated, hold down [SHIFT] while press [BASS] until it flashes.
 - Check to see if [MUTE] is off. If [MUTE] is indeed illuminated, press to turn it off.
 - Confirm that the DR-202's MIDI OUT is connected to the MIDI IN connector of the external MIDI sound Module.
 - Make sure that the MIDI channel (of the external part) set in the DR-202's MIDI settings matches the MIDI channel selected in the external MIDI sound Module.
 - Make sure that the pitch of the pad being tapped is one that can produced by the external MIDI sound Module.
- * For more detailed information, please see "MIDI settings" in "Section 8 Connecting External MIDI Devices" on p.58.
- * If using either SP-202 (sold separately) or MS-1 (also sold separately) as an external MIDI sound Module, please read "Controlling an SP-202 or MS-1" in "Section 8 Connecting External MIDI Devices" on p.62.

Performing with the Pads

Shifting Pad Pitches by Octaves (Octave Shift)

When performing with bass sounds and sounds from an external MIDI sound Module, you can shift within a range of up to eight octaves with the Octave Shift settings.

- * Octave Shift cannot be set when using drum sounds.
- * Pad key placements for drum sounds are unrelated to MIDI Note Numbers.

1. Press [KIT].

The kit appears in the display.

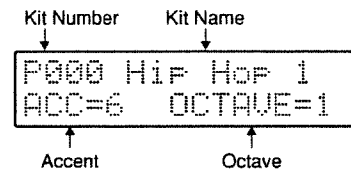

2. Press the [▶] cursor key to move the cursor to OCTAVE.

3. Rotate the VALUE dial to set the Octave Shift (from 0 to 7).

4. Press [KIT].

The previous screen returns to the display.

Chapter 4 Recording Patterns

A Note About Recording

Recording Methods

Patterns can be recorded using the two following methods.

Realtime Recording

In Realtime Recording, patterns are recorded by tapping the pad in time with the metronome. Patterns are repeatedly played back, and the input data is mixed with this.

Even if the timing of the taps is a bit uneven, it can be corrected before being input using the Quantize function.

In addition, input from an external MIDI device can also be recorded.

Step Recording

With Step Recording, while the timing of the sound played, pitch, and other settings for each tone are set and recorded one tone at a time. You can check the results as you input by listening to repeated playback of the patterns.

Switching Between Realtime and Step Recording

You can switch between Realtime Recording and Step Recording in the course of creating a single pattern. You can switch between each of the recording modes as shown below.

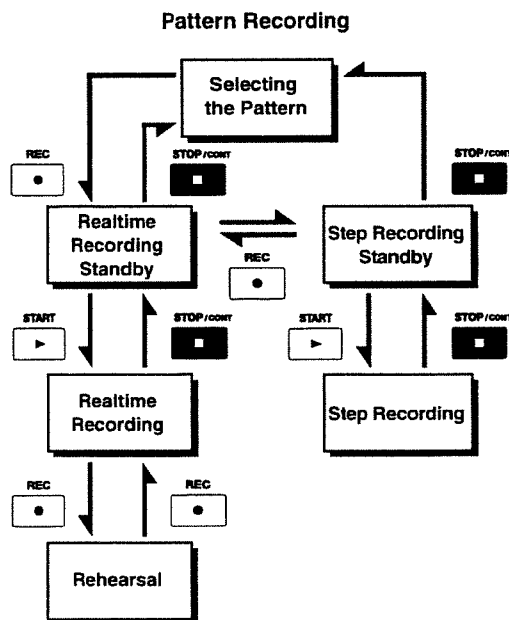

Parameters in Recording

The following parameters are set in recording.

Quantize:

(Q) Quarter Note, (Q3) Quarter-note Triplet,
(E) Eighth Note, (E3) Eighth-note Triplet,
(F) Sixteenth Note, (F3) Sixteenth-note Triplet,
(F3) Thirty-second Note, (F33) Thirty-second-note Triplet, Hi (4 x 96 = 384th Note)

In Realtime Recording, timing irregularities that occur when you tap the pads are corrected to the selected Quantize increment.

In Step Recording, this equals the smallest note length that can be input.

Number of Measures: 1-8

Beat: 1/4, 2/4, 3/4, 4/4

In Realtime Recording, these set the number of measures and the beat used as the count in the metronome.

Tick Time:

1-100 - 4-495 (four measures, four beats per measure)

In Step Recording, the position of the input sound is specified in terms of measure (the left digit), beat (the highest-place digit of the number on the right), and tick time (the two right-most digits of the number on the right).

* Tick time is an even finer division than the beat, counted in ninety-sixths of a beat.

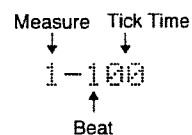

Instrument:

Please refer to the Instrument List (p.70)

When recording drum parts in Step Recording, instrument names are displayed at positions where data is entered.

* This setting does not affect bass parts and external parts.

* This does not apply in Realtime Recording.

Note Name:

C, C#, D, D#, E, F, F#, G, G#, A, A#, B

When recording bass parts and external parts in Step Recording, note names are displayed at positions where data is entered.

* This setting does not affect drum parts.

* This does not apply in Realtime Recording.

Octave: 0-7

This sets the octave (register) of sounds input through tapping of the DR-202's pads during recording of bass and external parts. However, when recording with external MIDI devices, this setting is disregarded, and the pitch is determined according to the Note message.

* This setting does not affect drum parts.

Gate Time: 0001-2047

In Realtime Recording of bass parts and external parts, gate time is the interval from when a pad is pressed to when it is released.

In Step Recording of bass and external parts, note length is specified by gate time.

- * The length of rolls played in drum parts is also determined according to gate time.
- * When the gate time value is 96, a quarter note equals one beat.
- * Notes cannot last longer than their gate time settings.

Accent: 1-8

This sets the accent (volume) when sounds are entered by tapping the DR-202's pads. However, when recording with external MIDI devices, this setting is disregarded, and the pitch is determined according to the Velocity message.

During recording, the Velocity message from an external MIDI device will be recorded as eight level accents, as shown as below.

Velocity	Accent
0-24:	1
25-40:	2
41-55:	3
56-70:	4
71-85:	5
86-100:	6
101-104:	7
115-127:	8

Timing Shift: -12-+12

This is a fine adjustment for advancing and retarding timing of input sounds in Step Recording.

BPM: 40.0-250.0

This adjusts the metronome tempo in Realtime Recording.

Realtime Recording

1. Pattern Mode

Press [STYLE] or [PATTERN].

The Pattern Mode screen appears in the display.

With Preset patterns:

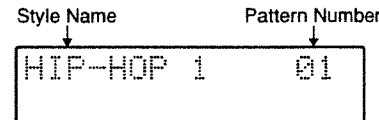

With the User patterns:

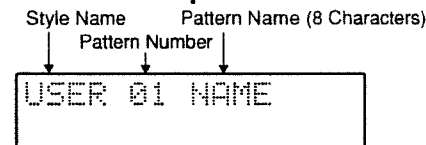

Selecting User Styles (USER)

Press [STYLE] or the [◀] cursor key to move the cursor to the Style name, then rotate the VALUE dial to select User Styles (USER).

* If the display shows anything other than a User Style (USER), then the DR-202 cannot be put in recording standby mode.

Selecting the Pattern

Press [PATTERN] or the [▶] cursor key to move the cursor to the pattern number, then rotate the VALUE dial to select the User pattern to be recorded.

2. Recording Standby

Press [REC]. [REC] flashes, the metronome begins to play, and the DR-202 is put in Realtime Recording standby mode.

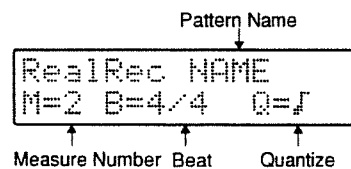

* Pressing [REC] further toggles the DR-202 between Step Recording standby and Realtime Recording standby.

Name the pattern.

You can add names you like to User Patterns (using a maximum of eight characters).

In Realtime Recording standby, press the [◀] cursor key to move the cursor to the pattern name. With the cursor keys, select the character position, then rotate the VALUE dial to change the character.

* You can erase a letter by pressing [DEL]. To enter a space, press [COPY/INST].

Select the number of measures, beat, and Quantize value.

Before beginning Realtime Recording, set the number of measures in the pattern, the beat, and the Quantize value. Use the cursor keys to select the parameters, and rotate the VALUE dial to make the settings.

Make the settings for any rolls to be played.

When recording rolls in drum parts, select the roll type and roll speed.

In Realtime Recording standby, press [ROLL], use the cursor keys to select the parameters, and rotate the VALUE dial to make the settings in each parameter selected.

Adjust the metronome.

For the metronome speed, press [BPM] to select a tempo that is easy to record in.

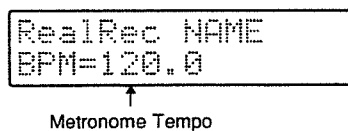

When you have finished adjusting the tempo, press [BPM] to return to the previous screen.

* During recording, the most recently designated BPM value is stored as the standard tempo for the pattern.

3. Beginning the Recording

Press [START]. [REC] changes to steady illumination, [START] flashes in time with the tempo, and recording begins.

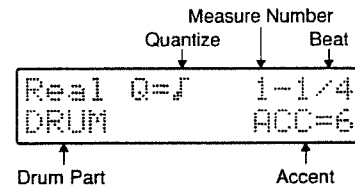

Rehearse the pattern.

When pressed during Realtime Recording, [REC] begins to flash, and the DR-202 goes into Rehearsal mode. In Rehearsal mode, the DR-202 does not begin recording even when the pads are tapped. Press [REC] once more, causing [REC] to be illuminated, to return to Realtime Recording.

* The same process is used in recordings that use note information from an external MIDI device.

4. Performance

Play (press) the pads in time with the sound of the metronome.

Switch parts.

To switch the parts, press [BASS]. To switch to the external part, hold down [SHIFT] while pressing [BASS].

[BASS] Illumination Off: Drum part

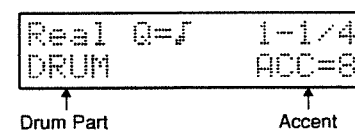

[BASS] Illuminated: Bass part

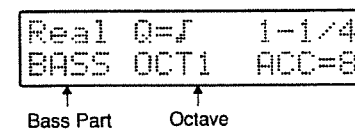

[BASS] Flashing: External part

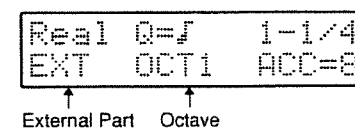

Switch the kit.

To switch kits, press [KIT].

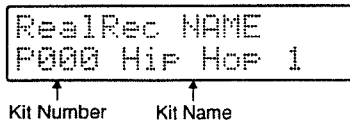

- * During recording, the most recently designated kit is stored for use in the pattern.
- * Press [KIT] once more to return to the previous screen.

Delete unnecessary notes.

You can delete unneeded notes in real time by holding down [DEL] while pressing the pads during Realtime Recording.

With drum parts, by holding down [DEL] while pressing the pads containing sounds you want to delete (more than one pad may be pressed simultaneously), the sounds corresponding to those pads are deleted only while the pads are pressed.

With bass parts and external parts, by holding down [DEL] while pressing the pads containing sounds you want to delete, the sounds corresponding to those pads are deleted only while the pads are pressed.

Record knob movements (Realtime Modify).

With the REALTIME MODIFY knobs (CUTOFF, RESONANCE, DECAY) during Realtime Recording, you can record using Realtime Modify.

- * Use the INSTRUMENT SELECT knob to select the instrument to be adjusted using Realtime Modify.
- * To delete a recorded knob movement (Realtime Modify), first select the modified instrument by using INSTRUMENT SELECT knob, then hold down [DEL] while rotating the knob. The movement is deleted from the moment the knob is moved to the end of the adjustment.
- * By using Realtime Modify during recordings, one blank measure is played back automatically in the repeating parts of the pattern (Loop Rest function). This blank measure (rest) is played back only during Realtime Recording. Furthermore, at this point you can delete all knob movements in the pattern by holding down [DEL] and rotating the knobs.

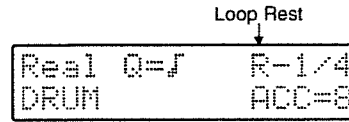

Loop Rest

When you record knob movements near the end of the pattern, if no blank space remains by the time you return to the beginning of the pattern, then the knob movements continue to be recorded back at the beginning of the pattern (overwriting previously recorded knob movements), just as if you started recording at the beginning of the pattern.

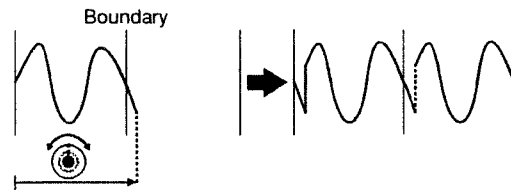

For that reason, if you record in Realtime Modify on the DR-202, a one-measure beat is inserted into repeating portions of patterns (Loop Rest function).

This provides an opportunity to stop movement of the knobs when repeating part of a pattern, making for smoother recording with Realtime Modify before and after the pattern.

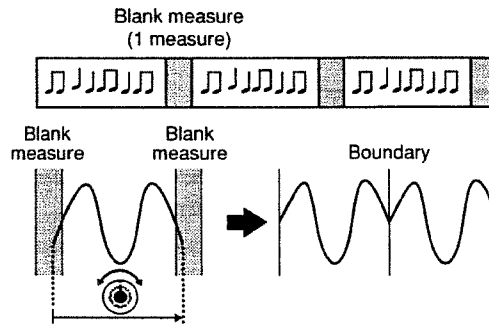

- * Inserted rests are played back only in Realtime Recording. They are not played when the pattern is played back after recording is finished.
- * Even if all inserted rests from Realtime Modify are deleted, they are still left in during recording. By first returning to record standby, then initiating the recording from the beginning, you can prevent the rests from being played back.

Recording Rolls in Realtime Recording

You can record rolls in the drum parts. To record rolls, press [ROLL] so that [ROLL] is illuminated.

- * Only one roll type and roll speed may be specified for each pattern. The settings last specified in record standby are then used in the recording.
- * Rolls cannot be performed in the bass or external parts.
- * To delete a Rolls, cause [ROLL] to illuminated, then press the pad that corresponds to the Rolls to be deleted while holding [DEL] down.

Add accents.

The accent (emphasis on the sound) for each note is as determined by the accent value (1–8) that appears in the lower right of the screen for each part (the accent is not affected by the force with which the pads are played). However, when recording with external MIDI devices, this setting is disregarded, and the accent is determined according to the Velocity information.

6. Finishing the Recording

Press [STOP/CONT]. [REC] begins to flash again, [START] is no longer illuminated, and the DR-202 is put in Realtime Recording standby.

How do I go back into Realtime Recording?

While in Realtime Recording standby, press [START]. [REC] is illuminated, [START] flashes in time with the tempo, and you can again conduct recordings in Realtime Recording.

How do I to switch to Step Recording?

While in Realtime Recording standby, press [REC]. This switches the DR-202 to Step Recording.

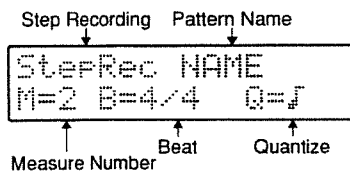

Press [START]. [REC] changes to steady illumination, the metronome stops, [START] flashes in time with the tempo, and you can conduct recordings in Step Recording.

How do I finish recording?

While in Realtime Recording standby, press [STOP/CONT].

[REC] illumination goes off, the metronome stops, and the DR-202 is put in Pattern mode.

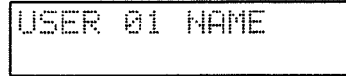

Step Recording

1. Pattern Mode

Press [STYLE] of [PATTERN]. The Pattern Mode screen appears in the display.

With Preset patterns:

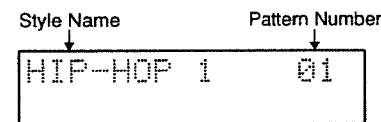

With User patterns:

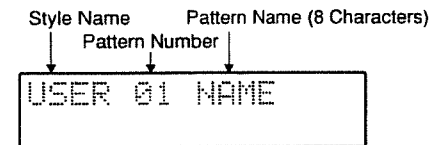

2. Selecting the Pattern

Selecting User Styles (USER)

Press [STYLE] or the [◀] cursor key to move the cursor to the Style name, then rotate the VALUE dial to select User Styles (USER).

- * If the display shows anything other than a User Style (USER), then the DR-202 cannot be put in recording standby mode.

Selecting the Pattern

Press [PATTERN] or the [▶] cursor key to move the cursor to the pattern number, then rotate the VALUE dial to select the User pattern to be recorded.

3. Recording Standby

Press [REC] twice. [REC] flashes, the metronome begins to play, and the DR-202 is put in Step Recording standby mode.

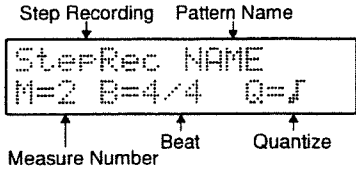

* Pressing [REC] further toggles the DR-202 between Realtime Recording standby and Step Recording standby.

Name the pattern.

You can add names you like to User Patterns (using a maximum of eight characters).

In Step Recording standby, press the [←] cursor key to move the cursor to the pattern name. With the cursor keys, select the character position, then rotate the VALUE dial to change the character.

* You can erase a letter by pressing [DEL]. To enter a space, press [COPY/INST].

Select the number of measures, beat, and Quantize value.

Before beginning Step Recording, set the number of measures in the pattern, the beat, and the Quantize value. Use the cursor keys to select the parameters, and rotate the VALUE dial to make the settings.

Make the settings for any rolls to be played.

When recording rolls in drum parts, select the roll type and roll speed.

In Step Recording standby, press [ROLL], use the cursor keys to select the parameters, and rotate the VALUE dial to make the settings in each parameter selected.

To end settings, press [ROLL] again.

Adjust the metronome.

For the metronome, press [BPM] to adjust tempo.

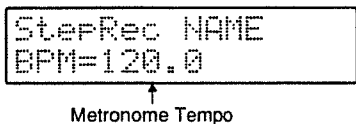

When you have finished adjusting the tempo, press [BPM] to return to the previous screen.

* During recording, the most recently designated BPM value is stored as the standard tempo for the pattern.

4. Beginning the Recording

Press [START]. [REC] changes to steady illumination, the metronome stops, [START] flashes in time with the tempo, and Step Recording is begun.

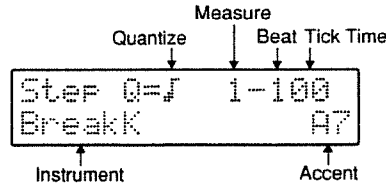

* It will automatically change to Realtime Recording, when the DR-202 receives MIDI "Start" message from external MIDI device.

5. Input

Press the pads to input the sounds.

To move forward or back only through the quantized increments, press [STEP -1/+1] ([STYLE], [PATTERN]). To move forward or back without regard to the Quantize function, press the cursor key to Quantize, measure, or Tick Time, then rotate the VALUE dial to move through the song.

For bass parts, external parts, and rolls in drum parts, note length is not related to how long the pad is pressed, but is instead determined by the gate time setting.

384	288	192	144	128	96	72	64
48	36	32	24	18	16	12	8

* You can not record the MIDI messages from external MIDI device while Step Recording is in progress.

Switch parts.

To switch parts, press [BASS]. To switch to the external part, hold down [SHIFT] before pressing [BASS].

[BASS] Illumination Off: Drum Part

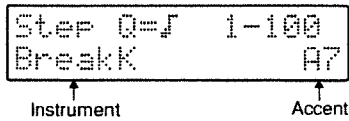

[BASS] Illuminated: Bass Part

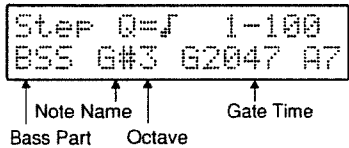

[BASS] Flashing: External Part

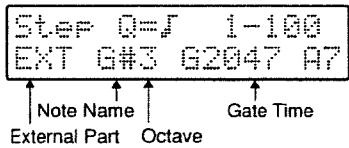

Switch the kit.

To switch kits, press [KIT].

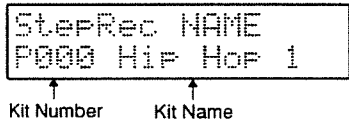

* Press [KIT] once more to return to the previous screen.

Delete unnecessary notes.

When [DEL] is pressed, the sound currently displayed on the screen is deleted.

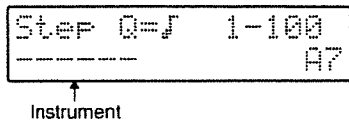

Recording Rolls in Step Recording

You can record rolls in the drum parts.

To record rolls, press [ROLL] so that [ROLL] is illuminated.

A symbol denoting a roll appears after the instrument name for sounds containing rolls.

* Only one roll type and roll speed may be specified for each pattern. The settings last specified in record standby are then used in the recording.

* Rolls cannot be performed in the bass or external parts.

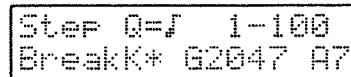

Display indicating a roll is performed

Step Recording of Portamento

You can record portamento in the bass part and external part in Step Recording.

To record portamento, press [PORTAMENTO] at the positions where you want it to be added. The portamento information is entered, and the display appears as follows.

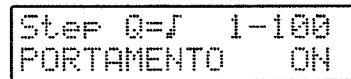

Displayed when entering a portamento value

Additionally, by holding down [SHIFT] while pressing [PORTAMENTO], you can input the portamento time.

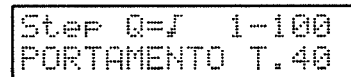

Portamento Time

* If the portamento time is not entered, then in the next performance, the most recently set (or performed) portamento time remains in effect.

* Portamento does not function in drum parts.

Add accents.

The accent for each note is determined by the accent value (1–8) that appears in the lower right of the screen for each part (the accent is unrelated to how hard the pads are struck). However, when recording with external MIDI devices, this setting is disregarded, and the accent is determined according to the Velocity message.

During recording, the Velocity message from an external MIDI device will be recorded as eight level accents, as shown as below.

Velocity	Accent
0–24:	1
25–40:	2
41–55:	3
56–70:	4
71–85:	5
86–100:	6
101–104:	7
115–127:	8

How do I finish recording?

While in Realtime Recording standby, press [STOP/CONT]. [REC] illumination goes off, the metronome stops, and the DR-202 is put in Pattern mode.

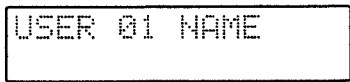

6. Finishing the Recording

Press [STOP/CONT]. [REC] begins to flash again, [START] is no longer illuminated, the metronome plays, and the DR-202 is put in Step Recording standby.

How do I go back into Step Recording?

While in Step Recording standby, press [START]. [REC] is illuminated, [START] flashes in time with the tempo, and you can again conduct recordings in Step Recording.

How do I switch to Realtime Recording?

While in Step Recording standby, press [REC]. The DR-202 switches to Realtime Recording standby.

Recording Patterns

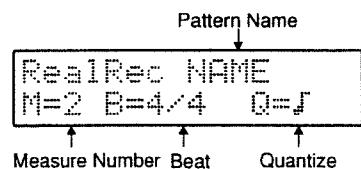

Press [START]. [REC] then changes to steady illumination, [START] flashes in time with the tempo, and you can conduct recordings in Realtime Recording.

Chapter 5 Editing Patterns

Editing of Patterns

Patterns are edited in Step Recording.

1. Pattern Mode

Press [STYLE] or [PATTERN]. The Pattern Mode screen appears in the display.

With Preset patterns:

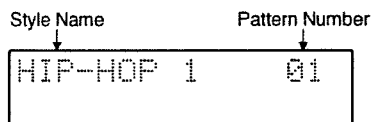

With User patterns:

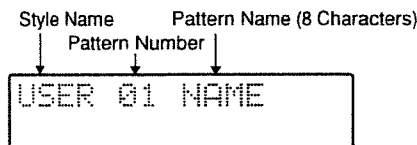

2. Selecting Patterns

Selecting User Styles (USER)

Press [STYLE] or the [◀] cursor key to move the cursor to the Style names, then rotate the VALUE dial to select the User Styles (USER).

* If the display shows anything other than a User Style (USER), then the DR-202 will not go into edit standby (Step Recording standby) mode.

Selecting the Pattern

Press [PATTERN] or the [▶] cursor key to move the cursor to the pattern numbers, and rotate the VALUE dial to select the User pattern to be edited.

3. Editing Standby

Press [REC] twice. [REC] flashes, the metronome begins to play, and the DR-202 is put in edit standby (Step Recording standby) mode.

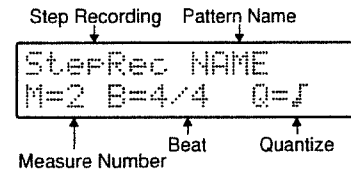

* Pressing [REC] further toggles the DR-202 between Realtime Recording standby and Step Recording standby.

4. Beginning to Editing

Press [START]. [REC] changes to steady illumination, the metronome stops, and [START] flashes in time with the pattern tempo.

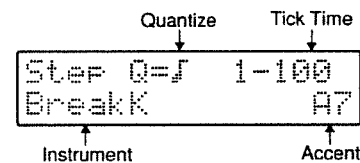

5. Editing

Move to the position to be edited.

To move forward or back only through the quantized increments, press [STEP -1/+1] ([STYLE], [PATTERN]). To move forward or back without regard to the Quantize function, press the cursor key to Quantize, measure, or Tick Time, then rotate the VALUE dial to move through the song.

Micro Search

If you only want to see location that contain data, use the Micro Search function.

Hold down [SHIFT] while pressing [STEP -1/+1] ([STYLE], [PATTERN]) to move forward or back to locations containing data.

* If there is no data either forward or back, the following will be displayed:

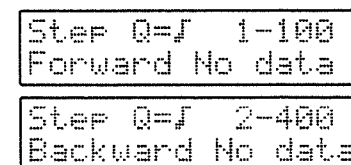

Check the Pad for the Drum Part

Press the Cursor Key [▶] while the cursor is placed at the lower right in the Drum Part. While you are pressing the Cursor Key [◀], the display window shows which Pad the current sound corresponds to.

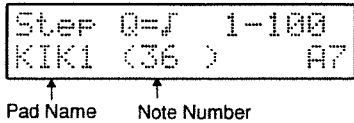

Switch parts.

To switch parts, press [BASS]. To switch to the external part, hold down [SHIFT] pressing [BASS].

[BASS] Illumination Off: Drum Part

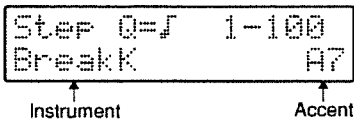

[BASS] Illuminated: Bass Part

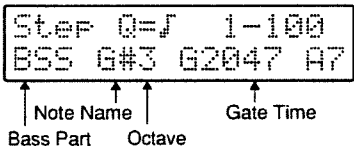

[BASS] Flashing: External Part

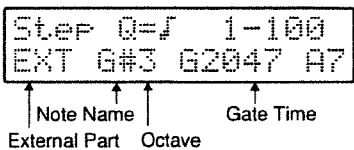

Editing Recorded Performance Data

Press the cursor keys to move the cursor to the parameters you want to edit, and rotate the VALUE dial to change the values.

Delete unnecessary notes.

When [DEL] is pressed, the sound currently displayed on the screen is deleted.

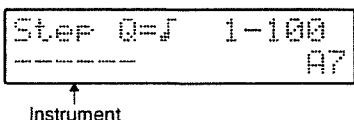

Editing Portamento Information

You can edit the portamento played in bass and external parts.

Move to the location containing the portamento information, press the cursor keys to move to the parameter to be edited, and rotate the VALUE dial to change the setting.

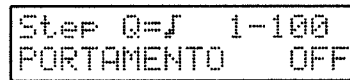

Displayed when entering a portamento value

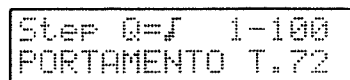

Portamento Time

* Portamento does not function in drum parts.

Adjusting the Timing of the Sounds' Expression (Timing Shift)

This is a fine adjustment for advancing and retarding timing of sounds in Step Recording.

When [T.SHIFT] is pressed, the degree of timing shift (-12+12) appears in the upper left of the display.

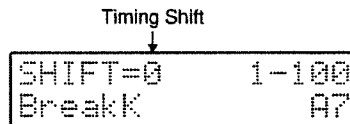

Rotate the VALUE dial to set the degree of timing shift.

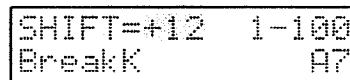

When [TAP/ENTER] is pressed, the previous editing screen returns, with the new position after the timing shift appearing in the screen.

Displayed after a timing shift has been set

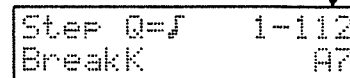

* You cannot set a Timing Shift that would extend beyond the forward or back of a pattern.

6. Finishing the Editing

Press [STOP/CONT]. [REC] begins to flash again, the metronome plays, [START] is no longer illuminated, and the DR-202 is put in edit standby (Step Recording standby).

How do I return to editing (Step Recording)?

While in editing standby (Step Recording standby), press [START]. [REC] is illuminated, the metronome stops, [START] flashes in time with the tempo, and you can edit (conduct recordings in Step Recording) again.

How do I switch to Realtime Recording?

While in editing standby (Step Recording standby), press [REC].

The DR-202 switches to Realtime Recording standby.

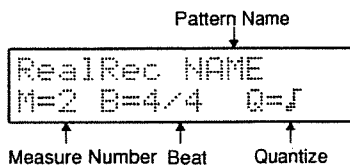

Press [START]. [REC] then changes to steady illumination, [START] flashes in time with the tempo, and you can conduct recordings in Realtime Recording.

How do I finish editing?

While in editing standby (Step Recording standby), press [STOP/CONT]. [REC] illumination goes off, the metronome stops, and the DR-202 returns to Pattern mode.

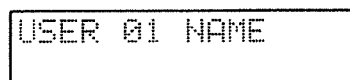

Giving a Groove to the Pattern (Groove Quantize)

Groove Quantize is a function that matches the timing and accents of a replayed pattern according to a fixed rhythmic "rule" (the Groove template). Applying Groove Quantize does not change the content of the pattern being replayed.

- * Groove Quantize can be used only in User patterns.
- * Up until the point where editing, turning off Groove Quantize returns the contents of the performance data to its previous conditions. As soon as editing is exited, the previous performance data cannot be restored.

1. Press [STYLE]. Confirm that the following appears in the display.

With Preset patterns:

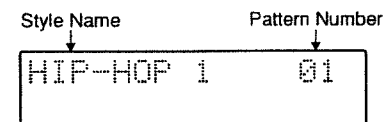

With User patterns:

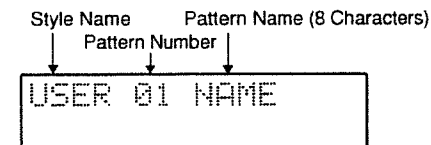

2. Rotate the VALUE dial to select the User Styles (USER).

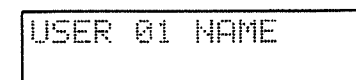

3. Press [PATTERN]. The cursor moves along under the pattern numbers.

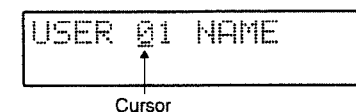

4. Rotate the VALUE dial to select the User pattern to which Groove Quantize is to be applied.

5. Press [GROOVE].

The Groove template appears in the display.

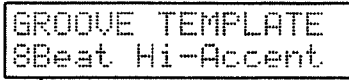

Groove Template Name

6. Rotate the VALUE dial to change the Groove template.

* Pressing [START] at this time allows you to check what the performance will be like once the changes have been made. If after checking this you want to make the changes, then first press [STOP/CONT] to stop the performance, then proceed.

No.	Template
1	8Beat Hi-Accent
2	8Beat Lo-Swing
3	8Beat Hi-Swing
4	8Beat Rhumba 1
5	8Beat Rhumba 2
6	8Beat Rhumba 3
7	16Beat Hi-Accent
8	16Beat Lo-Swing
9	16Beat Hi-Swing
10	16Beat Fusion 1
11	16Beat Fusion 2
12	16Beat Fusion 3
13	16Beat Reggae 1
14	16Beat Reggae 2
15	16Beat Reggae 3
16	Samba
17	Salsa
18	Triplets
19	Lagging Triplets
20	Sextuplets

7. Once you have determined which Groove template to use, press [GROOVE] once more. The previous User pattern reappears in the display, and the performance data after the Groove Quantize process is recorded.

* If you wish to undo the Groove Quantize, turn it OFF, then press [GROOVE], and the previous User Pattern returns.

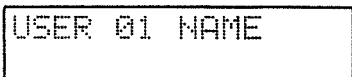

Changing the Pattern Setup Information

Only one set of setup data can be specified for each pattern. Playback occurs in accord with the most recent setup data, which was specified during editing (recording), or editing standby (recording standby).

* The following procedure can be carried out while in the process of editing (recording), or while in editing standby (recording standby).

Changing the Kit

This specifies the kit used in the pattern.

1. Press [KIT]. The kit used in the currently selected pattern appears in the display.

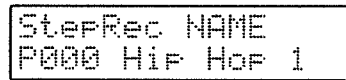

Kit Number Kit Name

2. Rotate the VALUE dial to change the kit.
3. Press [KIT]. The previous screen returns to the display.

Changing the Standard Tempo (BPM) Information

This specifies the tempo (in BPM) for the pattern.

* BPM stands for "beats per minute," the number of quarter notes in one minute.

Changing the Tempo with the VALUE Dial

1. Press [BPM]. The BPM appears in the display.

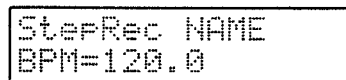

Value

2. Rotate the VALUE dial to change the tempo (from 40.0 to 250.0 BPM).

Tempos are adjustable in increments of 0.1 BPM.

When [SHIFT] is held down while the VALUE dial is rotated, the tempo changes in increments of 1 BPM.

Changing the Tempo by Tapping the Button (Tap Tempo)

You can also change the tempo according to the rate at which you tap [TAP/ENTER].

1. Tap [TAP/ENTER] four times at the tempo you want to change to. The tempo is calculated automatically, and the pattern changes to the new tempo corresponding to the timing of the strikes. The tempo then appears in the display.

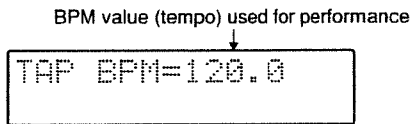

* The tempo cannot be changed if the rate at which [TAP/ENTER] is tapped falls outside the range of 40.0–250.0 BPM.

Changing the Roll Information

This specifies the roll speed and type for rolls to be played.

- * Rolls cannot be played with the bass sounds or sounds from an external MIDI sound generator.
- * This cannot be changed while editing (recording) is in progress.

Changing the Roll Type

1. Press [ROLL]. [ROLL] is illuminated, and the roll type appears in the display.

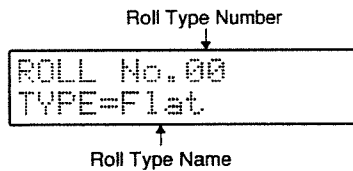

2. Rotate the VALUE dial to change the roll type.

No.0	Flat	No.17	Down Alt
No.1	Cresc	No.18–20	Down Dir1–3
No.2	Decresc	No.21–23	Lo-Fi1–3
No.3	Up	No.24–26	Hi-Fi1–3
No.4	Down	No.27–29	Lo-Fi1–3 Alt
No.5	Up Cresc	No.30–32	Lo-Fi1–3 Dir1
No.6	Down Cresc	No.33–35	Lo-Fi1–3 Dir2
No.7	Flat Dir	No.36–38	Hi-Fi1–3 Alt
No.8	Cresc Alt	No.39–41	Hi-Fi1–3 Dir1
No.9–10	Cresc Dir1–2	No.42–44	Hi-Fi1–3 Dir2
No.11	Decresc Alt	No.45–56	Phrase1–12 Dir
No.12	Decresc Dir	No.57–64	Fill1–8
No.13	Up Alt	No.65–67	Flam1–3
No.14–16	Up Dir1–3		

Changing the Roll Speed

1. Press [ROLL]. [ROLL] is illuminated, and the roll type appears in the display.

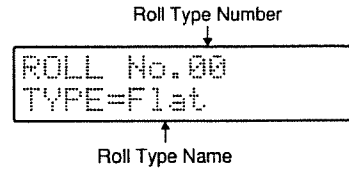

2. When the [▶] cursor key is pressed, the roll speed is displayed in the screen.

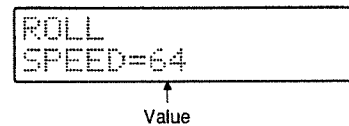

3. Rotate the VALUE dial to change the roll speed (00–127).

* Roll speed is unrelated to the tempo.

Changing the Mute Information

You can mute instruments individually with the Mute function.

1. Press [MUTE]. [MUTE] is illuminated, and the mute status appears in the display. Instrument names are expressed alphanumeric in the upper line of the display.

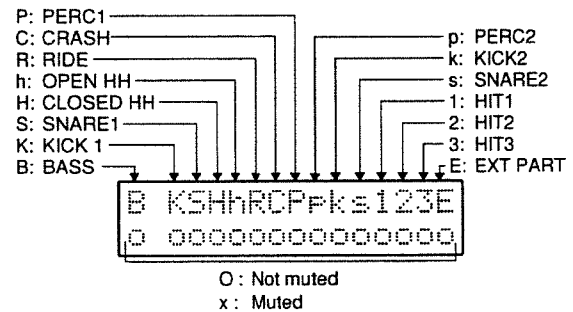

2. Pressing a pad switches the mute status for the instrument assigned to that pad.

o: Not muted, x: Muted

* To switch the mute status for external parts, press [MIDI].

* If [SHIFT] is held down while a pad is pressed, all instruments except for the one on that pad are muted (Solo function). Pressing the same pad while [SHIFT] is again held down returns the instrument to its previous mute status.

Chapter 5 Editing Patterns

- The display returns to the previous screen when [MUTE] is pressed. In this case, [MUTE] flashes if any instruments are muted.
 - * *The mute is not effective if the muted instrument is not used in the pattern.*

Deleting Patterns

- Press [STYLE]. The Pattern Mode screen appears in the display.

With Preset patterns:

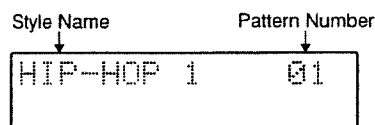

With User patterns:

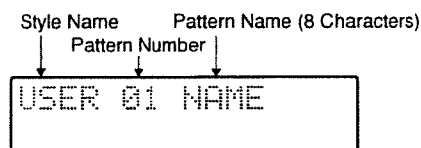

- Rotate the VALUE dial to select a User Style (USER).
 - * *Only User Styles can be deleted.*
- Press [PATTERN] or the [▶] cursor key to move the cursor to the pattern number, then rotate the VALUE dial to select the User pattern to be deleted.
- Press [DEL].
 - A confirmation message asking whether or not you want to delete the pattern appears on the screen.

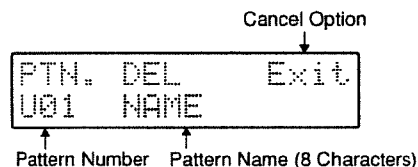

- * *If you wish to cancel the deletion, make sure that the [◀] cursor key is at "Exit," then press [TAP/ENTER] to to the previous screen.*
- Move the cursor to the pattern number, then press [TAP/ENTER]. The unit will present a message asking you to confirm that you really want to go ahead with the deletion.

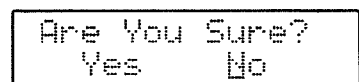

- To delete the pattern, press the [◀] cursor key move the cursor to "Yes," and then press [TAP/ENTER] once more.
 - The pattern is deleted, and this fact is indicated on the screen.
 - If you move the cursor to "No," and then press [TAP/ENTER], the delete is canceled, and the previous screen reappears in the display.

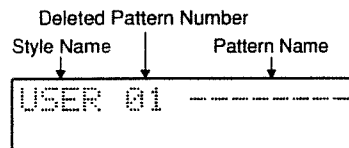

Copying Patterns

- Press [STYLE].
 - The Pattern Mode screen appears in the display.

With Preset patterns:

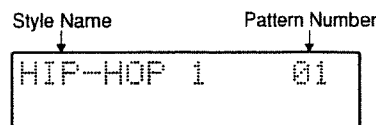

With User patterns:

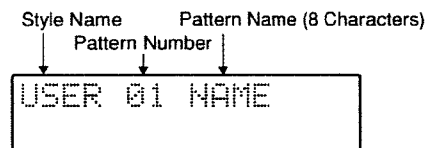

- Rotate the VALUE dial to select the Style that contains a pattern you want to use as the source for the copy.
- Press [PATTERN] or the [▶] cursor key to move the cursor to the pattern numbers, and rotate the VALUE dial to select the pattern to be copied.
- Press [COPY/INS].
 - A message asking where you want the copy of the pattern to be placed (the copy destination) appears in the display.

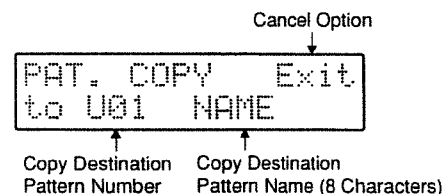

- * If you wish to cancel the operation, press the [◀] cursor key move the cursor to "Exit," and press [TAP/ENTER] to return to the previous screen.
5. Rotate the VALUE dial to select the pattern for the copy destination.
 6. When you have decided on a copy destination, press [TAP/ENTER].
A confirmation message asking whether or not you want to execute the procedure appears in the display.

```

Are You Sure?
  Yes   No
  
```

7. To copy the pattern, press the [◀] cursor key move the cursor to "Yes," and then press [TAP/ENTER] once more.
The pattern is copied, and this fact is indicated on the screen.
If you move the cursor to "No," and then press [TAP/ENTER], the copy is canceled and the previous screen reappears in the display.

```

Copy Destination Style Name
Copy Destination Pattern Number
Copy Destination Pattern Name
  
```

```

USER 02 NAME
  
```

Chapter 6 Creating Songs

About Recording

Recording Parameters

The following parameters are set in recording.

Step

The position of each pattern is called a step. The step at the beginning of a song is numbered 001, and patterns can be assigned up to a maximum length of 999 steps.

* *The longest step depends on the amount of memory available.*

Creating Songs (Song Recording)

1. Song Mode

Press [SONG].

The Song Mode screen appears in the display.

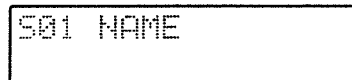

2. Selecting Songs

Rotate the VALUE dial to select the number of the song to be used for recording.

* *Song S20 is the demo song. This song cannot be used for recording.*

3. Recording Standby

Press [REC]. [REC] flashes, and the unit is put in Song Recording standby mode.

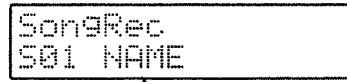

↑
Song Name

Change the initial tempo.

You can set the initial tempo (BPM) to be used when song playback starts. Press [BPM] to display the INIT BPM value (40.0–250.0), then change the value using the VALUE dial.

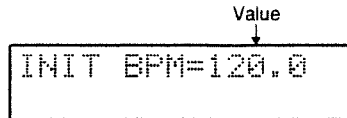

Press the [▶] cursor key again, and it is set to INIT BPM = RECOMMEND. This means that playback will accord with the standard tempo set for each pattern. Press [BPM] again to return to the previous display.

Name the song.

You can name User songs with names of your choice (up to a maximum of 12 characters).

Select the character positions with the cursor keys, and rotate the VALUE dial to change the characters to be used.

* *You can erase a letter by pressing [DEL]. To enter a space, press [COPY/INST].*

4. Beginning the Recording

Press [START].

[REC] changes to steady illumination.

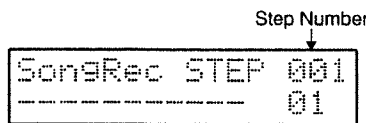

5. Input

Press the cursor keys to move the cursor to the Style name or pattern number and rotate the VALUE dial to select a pattern.

When you have decided on a pattern, press [STEP -1/+1] ([STYLE], [PATTERN]) to move through the steps.

Deleting Patterns

Press [STEP -1/+1] ([STYLE], [PATTERN]) to move to the step containing the pattern you want to delete. Press [DEL]; the pattern in the current step is deleted, and the patterns following steps are moved forward.

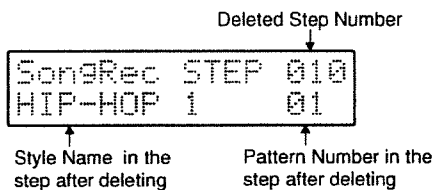

Inserting Patterns

Press [STEP -1/+1] ([STYLE], [PATTERN]) to move to the step containing the pattern you want to insert. Press [COPY/INS]; the selected pattern (HIP-HOP 1 01) is inserted, and the patterns following steps are moved back.

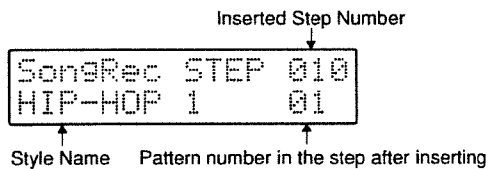

When changing the inserted pattern, rotate the VALUE dial to make the selection.

Confirming the Pattern (Preview)

Press [START]. [START] flashes, and the The pattern of the current step being recorded is played back.

* While you are playing a pattern, you can press [STEP -1/+1] ([STYLE], [PATTERN]) to shift the steps.

6. Finishing the Recording

Press [STOP/CONT]. [REC] flashes again, and the DR-202 goes into Song Recording standby.

How do I go back into Song Recording?

While in Song Recording standby, press [START]. [REC] is illuminated, and you can again conduct recordings in Song Recording.

How do I finish recording?

While in Realtime Recording standby, press [STOP/CONT]. [REC] illumination goes off, and the DR-202 returns to Song mode.

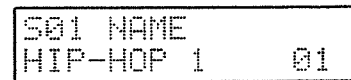

Deleting Songs

1. Press [SONG].

The Song Mode screen appears in the display.

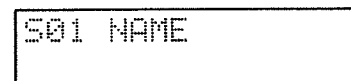

2. Rotate the VALUE dial to select the number of the song to be deleted.

* Song S20 is the demo song. This song cannot be deleted.

3. Press [DEL].

A confirmation message asking whether or not you want to delete the song appears on the screen.

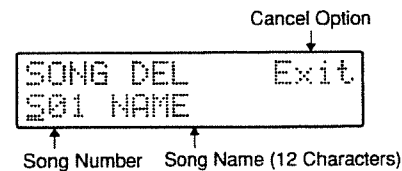

* If you wish to cancel the deletion, make sure that the [◀] cursor key is at "Exit," then press [TAP/ENTER] to go return to the previous screen.

4. Move the cursor to the song number, then press [TAP/ENTER].
The unit will present a message asking you to confirm that you really want to go ahead with the deletion.

```
Are You Sure?
  Yes   No
```

5. To delete the song, press the [◀] cursor key move the cursor to "Yes," and then press [TAP/ENTER] once more.
The song is deleted, and this fact is registered on the screen.
If you move to the cursor "No," and then press [TAP/ENTER], the delete is canceled, and the previous screen reappears in the display.

Deleted Song Number
Song Name

```
S01 -----
```

Copying Songs

1. Press [SONG]. The Song Mode screen appears in the display.

```
S01 NAME
```

2. Rotate the VALUE dial to select the song number to be used as the source for the copy.
* *Song S20 is the demo song. This song cannot be copied.*
3. Press [COPY/INS]. A message asking where you want the copy of the pattern to be placed (the copy destination) appears in the display.

Cancel Option

```
SONG COPY  Exit
to S01 NAME
```

Copy Destination Song Number
Copy Destination Song Name

- * *If you wish to cancel the copy, press the [◀] cursor key move the cursor to "Exit," and press [TAP/ENTER] to return to the previous screen.*

4. Rotate the VALUE dial to select the copy destination song.

* *Song S20 is the demo song. This song cannot be used as a copy destination.*

5. When you have decided on a copy destination, press [TAP/ENTER]. A confirmation message asking whether or not you want to execute the procedure appears in the display.

```
Are You Sure?
  Yes   No
```

6. To proceed with the copy, press the [◀] cursor key move the cursor to "Yes," and then press [TAP/ENTER] once more. The song is copied, and this fact is registered on the screen.

If you move to the cursor "No," and then press [TAP/ENTER], the copy is canceled and the previous screen reappears in the display.

Copy Destination Song Number
Copy Destination Song Name

```
S02 NAME
```

Chapter 7 Creating Original Kits

In addition to the 128 Preset kits that were stored in the DR-202 at the factory, 64 User kits are also provided. With User kits, you can freely edit the settings to create completely new kits.

Changing the Kit Setup

You can change the setups of both the Preset and User kits.

Although changes made to User kits are saved, changes to Preset kit setups are deleted when the kits are switched or if the power is cut, with the kits being restored to their original settings.

The following parameters can be changed:

Kit Name: 11-character maximum
Instrument: Please refer to the Instrument List (p.70)

(Instrument Parameters)

LEVEL: 0–15
PITCH: -100→+100
PAN: Left 7-Center-Right 7
REV/DLY SEND: 0–100
FLANGER SEND: 0–100
CUTOFF: -50→+50
RESONANCE: -50→+50
DECAY: -50→+50

(EFFECTS PARAMETERS)

REVERB/DELAY TYPE:

Small Room, Studio, Club, Lounge, Large Hall, Dark Hall, Plate 1, Plate 2, Stereo Delay, Pan Delay

REVERB TIME: 0–100

REVERB E.LEVEL: 0–127

DELAY TIME:

5–450 ms, (♩♩) half-note triplets, (♩.) dotted quarter notes, (♩) quarter notes, (♩♩) quarter-note triplets, (♩.) dotted eighth notes, (♩) eighth notes, (♩♩) eighth-note triplets, (♩.) dotted sixteenth notes, (♩) sixteenth notes, (♩♩) sixteenth-note triplets

DELAY E.LEVEL: 0–100

DELAY FEEDBACK: 0–127

FLANGER TYPE: Jet Flanger, Soft Flanger, Hard Flanger, Cold Flanger

FLANGER RATE: 0–100

FLANGER E.LEVEL: 0–127

* MIDI Program Change messages cannot be received while kits are being edited.

Selecting the Tones for Each Instrument

1. Press [KIT].

The kit used in the currently selected pattern appears in the display.

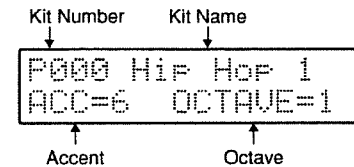

2. Rotate the VALUE dial until the kit you want to change to appears in the display.

* Although you can make changes to the Preset kits, the contents of changed settings are deleted when kits are switched or if the power is cut. If you want to save the changes, copy the contents of the Preset kit to a User kit,

3. Pressing the [▶] cursor key switches the display (the bass instrument name appears in the lower row of the display).

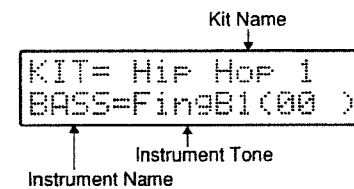

4. Rotate the VALUE dial to select the instrument to which you want to change.

* You can also select instruments by pressing the corresponding pads. To select bass parts, press [BASS], and when [BASS] is illuminated press the pad (any of the pads may be pressed).

* If setting effect parameters now, then select EFFECTS EDIT at this point.

5. Press the [▶] cursor key to move the cursor to the parameter value you want to change.

6. Rotate the VALUE dial to make the setting.

7. When you have made the setting, press [KIT] to return to the previous screen.

Naming the Kit

1. Press [KIT].
The kit used in the currently selected pattern appears in the display.

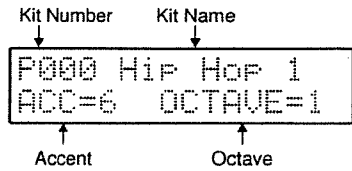

2. Rotate the VALUE dial until the kit whose name you want to change appears in the display.
3. Pressing the [▶] cursor key switches the display (the bass instrument name appears in the lower row of the display).

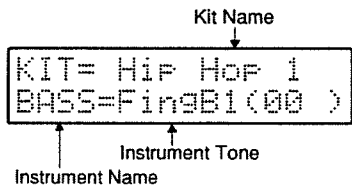

4. Press the [◀] cursor key to return the cursor, moving the cursor to the beginning of the kit name (in the upper row).
5. Press the cursor keys to move the cursor to the characters you want to change.
6. Rotate the VALUE dial to change the characters.
 - * You can delete characters by pressing [DEL].
 - * You can insert spaces by pressing [COPY/INS].
7. When you have finished making the settings, press [KIT] to return to the previous screen.

Copying a Kit

1. Press [KIT].
The kit used in the currently selected pattern appears in the display.

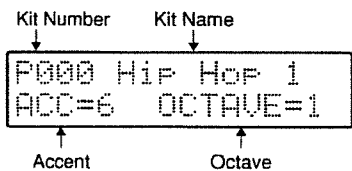

2. Rotate the VALUE dial until the kit you want to be used as the copy source appears in the display.
3. Press [COPY/INS].
A message asking for the copy destination appears in the display.

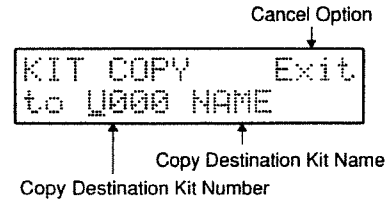

* If you wish to cancel the copy, press the [◀] cursor key move the cursor to Exit, and press [TAP/ENTER] to return to the previous screen.

4. Rotate the VALUE dial to select the copy destination kit.
5. When you have decided on a copy destination kit, press [TAP/ENTER].

A confirmation message asking whether or not you want to execute the procedure appears in the display.

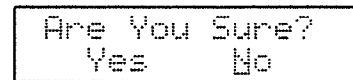

6. To proceed with the copy, press the [◀] cursor key move the cursor to "Yes," and then press [TAP/ENTER] once more.
The kit is copied, and this fact is registered on the screen.
If you move the cursor to "No," and then press [TAP/ENTER], the copy is canceled and the previous screen reappears in the display.

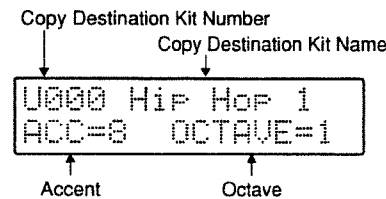

7. Press [KIT] to return to the previous screen.

Chapter 8 Connecting External MIDI Devices

What is MIDI?

MIDI (Musical Instrument Digital Interface) is a standard protocol for the exchange of performance and other information between electronic instruments and computers. Data can be sent and received by devices featuring MIDI connectors when these devices are connected by MIDI cables.

MIDI Connectors

The DR-202 features one MIDI IN and one MIDI OUT connector.

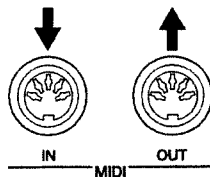

MIDI IN

This receives data from a connected external MIDI device. It is connected to the external MIDI device's MIDI OUT connector.

MIDI OUT

This sends out the DR-202's data. It is connected to the MIDI IN connector of the external MIDI device. In addition, when the Soft Through switch in the MIDI Mode settings is set to ON, data received via the DR-202's MIDI IN connector can be sent out unchanged from the MIDI OUT connector as well.

MIDI Channels

MIDI utilizes channels, called MIDI channels (1-16), that resemble television channels. Once the sending and receiving devices are on the same channel, information can then be exchanged.

Each of the DR-202's drum, bass, and external part settings can be made independently.

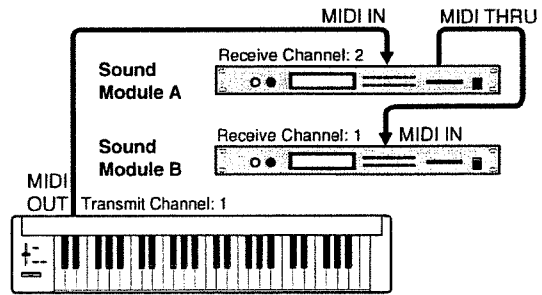
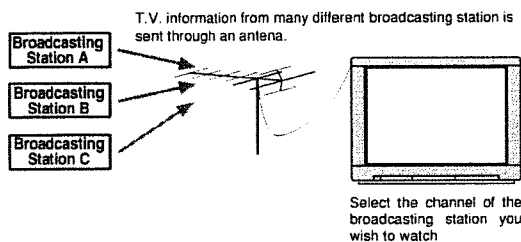

MIDI Information Handled by the DR-202

With MIDI, various kinds of performance-related information can be transmitted. Accordingly, there is a variety of data types (messages). MIDI information is divided into that which is handled on a channel basis (Channel messages), and that which is handled irrespective of channels (System messages).

Information Handled by Each MIDI Channel (Channel Messages)

These are messages for transmitting information about operations during performances.

Note Messages

Shown below are the different Note messages.

Note Number: pad position (register)

Note On: pad is being pressed

Note Off: pad is being released

Velocity: accent setting

* Note Numbers are handled differently by drum parts and other part (bass and external parts).

• Drum Part

A Note Number is assigned to each of the 13 pads (KICK1, SNARE1, etc.) that make up the drum parts, allowing each of the pads (KICK1, SNARE1, etc.) to play different sounds as their corresponding Note Numbers are sent. In addition, another 13 Note Numbers, different than those for the 13 regular sounds, are assigned for use with roll sounds.

• Bass and external part

Registers are treated as is.

Program Change

You can change the DR-202's kits.

* MIDI Program Change messages cannot be received while kits are being edited.

Control Change

These send modulation and panpot information for increased expression in performances. Each function is distinguished by a separate Control Number.

Messages Handled Irrespective of MIDI Channels (System Messages)

System messages include Exclusive messages, and other messages, such as those necessary for synchronization and the prevention of errors.

System Exclusive

These messages are used when storing the DR-202's pattern settings or overall settings in a connected DR-202 or external sequencer.

Common

This category includes Song Select, which gives information concerning the selection of songs; and Song Position Pointer, used for indicating the position currently being played in a song.

Realtime

These are messages used during synchronized performances.

These include Clock Transmit, used for matching tempos, performance Start/Stop, and Continue Start (for restarting songs stopped while in progress).

In addition, Active Sensing messages help prevent stuck notes when using external MIDI devices connected by MIDI cables or by other means.

About the MIDI Implementation Chart

Not all MIDI messages can be exchanged between all devices; the messages from one device must also be supported by the other device that it hopes to communicate with.

For this reason, owner's manuals for MIDI devices include a MIDI Implementation Chart to allow the user to quickly see which other devices are compatible. By comparing the MIDI implementation charts, you can check to see which messages can be exchanged.

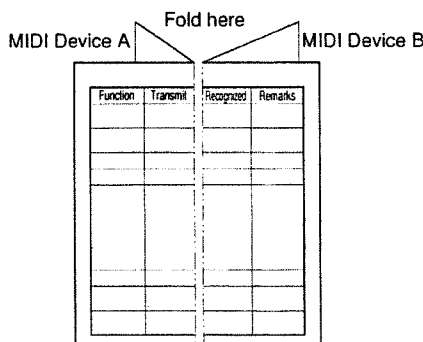

MIDI Settings

You can set the following parameters.

CHANNEL DRUM : 1-16

CHANNEL BASS : 1-16

CHANNEL EXT : 1-16

These set the MIDI channels for each part.

```
MIDI CHANNEL
DRUM=10
```

PROG CHG SW: OFF, ON

This setting determines whether or not Program Change messages are sent and received.

```
MIDI PROG CHG
SW=ON
```

VOLUME SW: OFF, ON

This setting determines whether or not Volume messages (Control Change messages) are received. Volume changes when Volume messages for the MIDI channels in each part are received.

```
MIDI VOLUME
SW=ON
```

VOLUME DRUM: 0-127

VOLUME BASS: 0-127

VOLUME EXT: 0-127

These set the volume levels in each part.

When the MIDI Volume Switch is set to ON, the parts receive Volume messages (Control Change messages), changing the value for the MIDI Volume.

```
MIDI VOLUME
DRUM=127
```

EXPRESSION SW: OFF, ON

This setting determines whether or not Expression messages (Control Change messages) are received. Volume changes when Expression messages for the MIDI channels in each part are received.

* Each part's volume is determined by two kinds of messages, Volume messages (Control Change messages) and Expression messages (also Control Change messages). The volume controls for each part work like two volume controls in series.

```
MIDI EXPRESSION
SW=ON
```

CONTROL CHG SW: OFF, ON

This determines whether to transmit and receive the Control Change messages (except Volume and Expression messages) or not. When the device receive the Control change messages that correspond to the MIDI channel of each Part, the relevant Parameters (refer to MIDI implementation) will change accordingly.

```
MIDI CONTROL CHG
SW=ON
```

THRU SW: OFF, ON

This setting determines whether or not the information received via the MIDI IN connector is sent from the MIDI OUT connector as is.

```
MIDI THRU
SW=OFF
```

OUT ASSIGN DRUM: INT, EXT, INT+EXT

OUT ASSIGN BASS: INT, EXT, INT+EXT

These set the output destinations of each part's performance information. When set to INT, only the DR-202's own sounds are played, and no performance information is output. When set to EXT, the DR-202's sounds are not played; instead, only performance information is output. When set to INT+EXT (factory setting), the DR-202's sounds are played, and performance information is output as well.

```
MIDI OUT ASSIGN
DRUM=INT
```

SYNC MODE: INT, MIDI, REMOTE, AUTO

This mode is for settings used in synchronizing performances of external MIDI devices and the DR-202.

```
MIDI SYNC
MODE=AUTO
```

	START / STOP	Tempo
INT	Controlled by the DR-202 at all times	Performed at the tempo set by the DR-202
MIDI	Controlled by the DR-202	Performed at the tempo set by the MIDI Clock signal
	Controlled by the external MIDI device	
REMOTE	Controlled by the DR-202	Performed at the tempo set by the DR-202
	Controlled by the external MIDI device	
AUTO	Controlled by the DR-202	Performed at the tempo set by the DR-202
	Controlled by the external MIDI device	Performed at the tempo set by the MIDI Clock signal

* Upon powerup, AUTO is automatically selected.

SYS EXCLUS: 17-32

This setting determines whether or not System Exclusive messages are sent and received and sets the device ID number for sending and receiving messages. When sending and receiving System Exclusive messages, be sure to match the ID number for each device.

```
MIDI SYS EXCLUS
DEVICE ID=17
```

BULK DUMP: All, SongPattern, Kit, UtilityMIDI

This stores the patterns created with the DR-202, the DR-202's settings, and other information on a second connected DR-202, sequencer, or other device.

```
MIDI BULK DUMP
TX ALL
```

- All: Sends all of the DR-202's internal settings.
- SongPattern: Sends song and pattern settings.
- Kit: Sends kit settings.
- UtilityMIDI: Sends UTILITY and MIDI settings.

Connecting External MIDI Devices

How to Make Settings

1. Press [MIDI].
The MIDI Mode screen appears in the display.
- * *The DR-202 cannot go into MIDI mode while a performance is in progress, even when [MIDI] is pressed.*

```
MIDI CHANNEL  
DRUM=10
```

2. Press the [▶] cursor key to select the parameter you want to set.
3. Rotate the VALUE dial to make the setting.
4. To end settings, press [MIDI].

How to Conduct Bulk Dump

1. Press [MIDI].
The MIDI Mode screen appears in the display.
The DR-202 cannot go into MIDI mode while a performance is in progress, even when [MIDI] is pressed.

```
MIDI CHANNEL  
DRUM=10
```

2. Press the [▶] cursor key so that the MIDI Bulk Dump parameters are displayed.

```
MIDI BULK DUMP  
TX ALL
```

3. Rotate the VALUE dial to select the data to be sent.
4. Press [TAP/ENTER]; transmission begins, and the status during transmission is displayed on the screen.

```
MIDI BULK DUMP  
TX ALL...
```

5. After a few moments, the transmission is completed, and this fact is shown on the screen.

```
MIDI BULK DUMP  
FINISH
```

How to Conduct Bulk Load

The following conditions must be met in order to carry out a Bulk Load:

- The unit must be in MIDI mode (p.26).
- Play must be stopped.

Synchronizing Performances with External MIDI Devices

When synchronizing the DR-202 with an external MIDI device, it is necessary to decide which device is to start and stop operations and which device's tempo is to be used.

Synch Mode Settings

The DR-202's Synch mode settings are made in MIDI mode.

1. Press [MIDI].

The MIDI Mode screen appears in the display.

* The DR-202 cannot go into MIDI mode while a performance is in progress, even when [MIDI] is pressed.

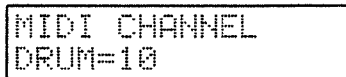

2. Press the [▶] cursor key to select the Sync mode parameter you want to set.



3. Rotate the VALUE dial to make the Synch mode setting (INT, MIDI, REMOTE, AUTO,).

	START / STOP	Tempo
INT	Controlled by the DR-202 at all times	Performed at the tempo set by the DR-202
MIDI	Controlled by the DR-202	Performed at the tempo set by the MIDI Clock signal
	Controlled by the external MIDI device	
REMOTE	Controlled by the DR-202	Performed at the tempo set by the DR-202
	Controlled by the external MIDI device	
AUTO	Controlled by the DR-202	Performed at the tempo set by the DR-202
	Controlled by the external MIDI device	Performed at the tempo set by the MIDI Clock signal

* Upon powerup, AUTO is automatically selected.

Making the Connections for Synchronized Performances

Use a MIDI cable to connect the MIDI OUT connector of the master device and the MIDI IN connector of the slave device.

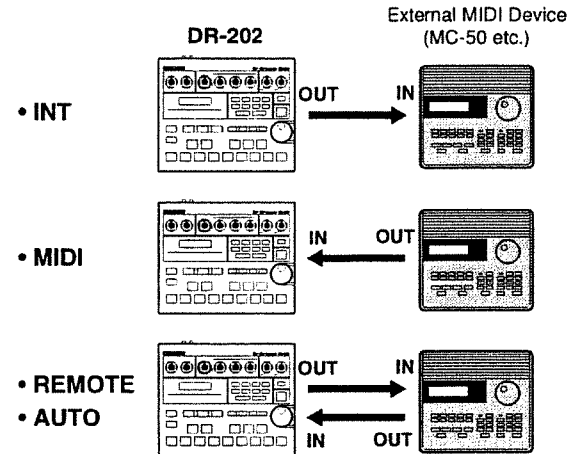

Controlling an SP-202 or MS-1

By putting the DR-202 together with the Roland SP-202 or MS-1 samplers (both sold separately), you can use the DR-202's pads to play samples (voices and effects) recorded with these samplers, create patterns combining sounds played by the DR-202 with the sampler's sampled sounds, and more, all for truer performances.

- * *About the SP-202: This is one of the samplers in BOSS Dr. Series. When playing back or conducting simple sampling (recording) using the included CD, a record, microphone, or other input, you can control filters, time stretch, and other parameters with the DR-202's knobs.*
- * *About the MS-1: This is a phrase sampler containing a simple sequencer. You can also make more detailed settings to sampled phrases on it.*

Here, using the SP-202 as an example, is a description of the procedure for controlling the other device.

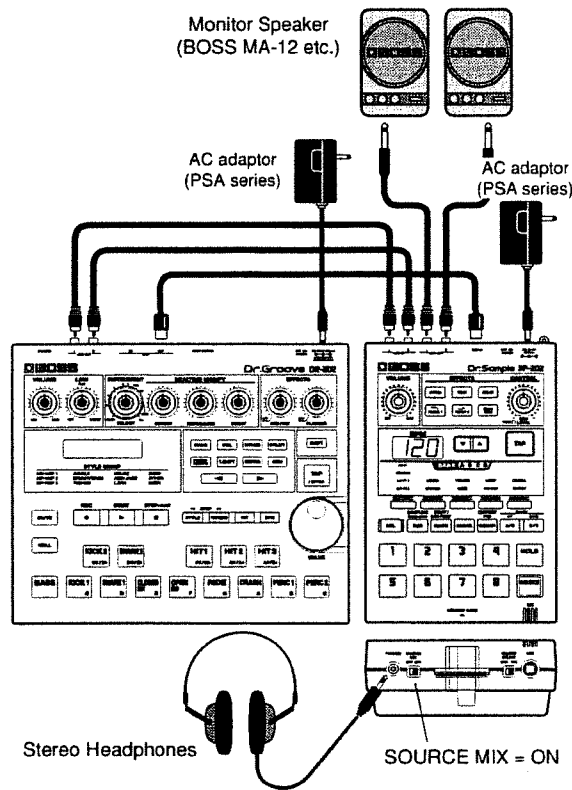

Set the Note Numbers of the DR-202's Pads to the same numbers as the Note Numbers of the SP-202's Pads

1. While holding down the SP-202's [SOURCE], turn on the power switch. The SP-202's MIDI settings are as shown below (these settings are saved even when the power is switched off).

● Note numbers and pads

Pads	SOURCE	A1	A2	A3	A4	A5	A6	A7	A8
Note	B1	C2	C#2	D2	D#2	E2	F2	F#2	G2
Note number	35	36	37	38	39	40	41	42	43
Pads	B1	B2	B3	B4	B5	B6	B7	B8	
Note	G#2	A2	A#2	B2	C3	C#3	D3	D#3	
Note number	44	45	46	47	48	49	50	51	
Pads	C1	C2	C3	C4	C5	C6	C7	C8	
Note	E3	F3	F#3	G3	G#3	A3	A#3	B3	
Note number	52	53	54	55	56	57	58	59	
Pads	D1	D2	D3	D4	D5	D6	D7	D8	
Note	C4	C#4	D4	D#4	E4	F4	F#4	G4	
Note number	60	61	62	63	64	65	66	67	

Receive channel: 1

2. Set Channel 1 as the external part's MIDI channel. Press [MIDI] to put the DR-202 in MIDI mode, press the [▶] cursor key to display the (external part's) MIDI channel, and rotate the VALUE dial to make the setting.

* *Any MIDI channel can be used if the DR-202's and SP-202's MIDI channels are in agreement.*

3. Press the DR-202's [BASS] while holding down [SHIFT]. [BASS] flashes, and the DR-202 can then play the external part.

4. Set Octave Shift, shifting the register to match that of the MIDI Note displayed.

Press [KIT] so that the octave appears in the display, press the [▶] cursor key to place the cursor at the desired Octave, then rotate the VALUE dial to make the setting.

Similarly, with the MS-1, set the MIDI channels so that they are in agreement, and make the settings for the external part's performance and Octave Shift.

Additionally, when playing SP-202 or MS-1 samples in patterns, follow the steps described above, then create a pattern in the external part.

Follow the procedure "Chapter 4 Recording Patterns" on p.37 to record onto an external part; while holding [SHIFT] down, select the external part you want by pressing [BASS].

- * *In the MS-1's original factory settings, aside from the A# key, no samples are assigned to any black keys, so sample sounds for the DR-202's "KICK2," "SNARE2," "HIT1," and "HIT2" cannot be played, even if the pads are pressed. If you want to play MS-1 sample sounds with these pads, then, using the procedure described in "Changing key/pad assignments" in the MS-1 Owner's Manual (p.21), assign them to the key names corresponding to the DR-202's pads.*

Chapter 9 Other Functions (Utility Mode)

Utility Settings

The following parameters are available.

LCD CONTRAST: 0-10

This adjusts the display's contrast.

```
UTILITY
LCD CONTRAST=5
```

FOOT SWITCH ASSIGN:

StartStop, ContStop, KICK1, KICK2, SNARE1, SNARE2, CLOSED HH, OPEN HH, RIDE, CLASH, PERC1, PERC2, HIT1, HIT2, HIT3

This determines the function to be performed by the foot switch connected to the FOOT SWITCH jack (on the rear of the device).

* This function do not work while recording is in progress.

```
UTIL:FOOT SWITCH
ASSIGN=StartStop
```

- **StartStop:** When in the Song or Pattern mode, it works just like [START] and [STOP/CONT] (STOP only).
- **ContStop:** When in the Song Mode or Pattern Mode, it works just like [STOP/CONT].
- **KICK1-HIT3:** Any of these Instruments can be played by using the pedal.

AVAIL MEMORY: 0-100%

This indicates the remaining memory that the songs and patterns share.

* This is not a parameter that accepts a setting.

```
UTIL:AvailMemory
90%
```

Strong Beat INST:

808RIM, 909RIM, Click, Drystk, TriaOp, TriaMt, Claves

This selects the Instrument for the click sound of the metronome that will play at the start of a measure in Realtime recording.

```
UTIL:Strong Beat
INST=Drystk(134)
```

↑ ↑
Instrument Name Number

Weak Beat INST:

808RIM, 909RIM, Click, Drystk, TriaOp, TriaMt, Claves

This selects the Instrument for the click sound of the metronome that will play on the notes other than the start of a measure in Realtime recording.

```
UTIL:Weak Beat
INST=909RIM(130)
```

↑ ↑
Instrument Name Number

Strong Beat LEVEL: 0-15

This determines the volume for the click sound of the metronome that is played at the start of a measure in Realtime recording.

```
UTIL:Strong Beat
LEVEL=10
```

Weak Beat Level: 0-15

This determines the volume for the click sound of the metronome played on the notes other than the start of the measure in Realtime recording.

```
UTIL:Weak Beat
LEVEL=6
```

How to set the Parameters

1. Press [UTILITY]. The Utility Mode screen appears in the display.

```
UTILITY
LCD CONTRAST=5
```

2. Press the cursor key [▶] to select the parameter to be set.

3. Set the value by rotating the VALUE dial.

Troubleshooting

If sound cannot be produced, or when operations start going wrong, first check the points listed below. If the unit still does not function as intended, contact your dealer nearest Roland service center.

* Roland assumes no liability for loss or damage of any data or recorded content.

Problem: There is no sound.

Cause: The DR-202 or connected device is not turned on.

- With the volume turned down, first turn on the power of the connected device, then turn on the DR-202 itself (p.10,11).

Cause: The volume on the DR-202 or connected device is turned down.

- Raise the volume (p.11).

Cause: Audio cables, MIDI cables, or the like have not been properly connected.

- With the power turned off, reconnect the cables properly (p.10).

Cause: All instruments are muted (Mute function).

- Press [MUTE]. [MUTE] is illuminated, and the Mute status is displayed.

If [SHIFT] is held down while [MUTE] is pressed, all mutes are lifted (All Mute Lift function) (p.32).

Cause: The sound pitch exceeds the acceptable range of pitches (Octave Shift).

- Press [KIT] to change to the [KIT] screen. Press the [▶] cursor key to move the cursor to Octave in the lower right of the display screen, then rotate the VALUE dial to change the Octave Shift (p.35).

Cause: Output Assign is set to EXT, so performance information is not being sent to the internal sound generator.

- Press [MIDI] to change to the MIDI Mode screen. Press the [▶] cursor key to display Output Assign, and rotate the VALUE dial to change the setting to INT or INT+EXT (p.59, 60).

Problem: Sound is intermittent.

Cause: You are trying to express more than the maximum simultaneous polyphony (24 voices).

- Reduce the number of sounds being played (p.25).

Problem: The performance does not start, even after [START] is pressed.

Cause: Synch mode has been switched to MIDI, and the DR-202 is waiting for the Start signal from the external MIDI device.

- Press [MIDI] to change to the MIDI Mode screen. Press the [▶] cursor key to display Synch Mode, and rotate the VALUE dial to change the setting to INT (p.59, 60).

Problem: Effects are not being applied.

Cause: The instrument effect send levels in the kit settings are lowered.

- Press [KIT] to call up the Kit screen. Press the [▶] cursor key until the send level to the reverb/delay or flanger appears in the display. Press the pad for any instrument to which effects were not being applied to select the instrument, then rotate the VALUE dial to change the setting (p.55).

Cause: The delay effect level is lowered.

- Rotate the REV/DLY knob. Press the [▶] cursor key until the delay effect level appears in the display, then rotate the VALUE dial to change the setting (p.30, 31).

Problem: The pitch has shifted.

Cause: The instruments' pitches have been shifted.

- Press [KIT] to call up the Kit screen. Press the [▶] cursor key until the pitch appears in the display. Select the instruments by pressing the pad for any desired instrument to which pitch has shifted, then rotate the VALUE dial to change the setting (p.55).

Problem: The sound during playback of patterns is plodding and disjointed.

Cause: If a pattern either takes up an extremely large amount of memory or contains many knob movements, playback of the pattern may be “sticky” or disjointed. Furthermore, this problem may occur when the tempo is set faster than necessary.

- Delete any unneeded note or knob movement information (p.45-51).

Problem: Patterns cannot be recorded.

Cause: The DR-202 cannot be put in recording standby with a Preset pattern selected.

- Press [STYLE] and rotate the VALUE dial to select the User Styles (USER). Press [PATTERN] and rotate the VALUE dial to select the pattern to be recorded (p.38).

Cause: There is not enough memory remaining.

- Press [UTILITY], then press the [▶] cursor key to display the remaining memory. If there is no memory remaining, delete unneeded data from User patterns or User songs (or save data using Bulk Dump if necessary) to free up memory for further use (p. 63, 45-54).

Problem: Songs cannot be recorded.

Cause: The DR-202 cannot be put in recording standby when the demo song (S20) is selected.

- Rotate the VALUE dial to select the song (other than S20) to be recorded (p.25).

Cause: There is not enough memory remaining.

- Press [UTILITY], then press the [▶] cursor key to display the remaining memory. If there is no memory remaining, delete unneeded data from User patterns or User songs (or save data using Bulk Dump if necessary) to free up memory for further use (p. 63, 45-54).

Problem: The display screen is difficult to see.

Cause: The contrast is not properly adjusted.

- Press [UTILITY] to have LCD contrast setting displayed, the rotate the VALUE dial to adjust the setting (p.63).

Problem: Sounds from the external MIDI device are not being played.

Cause: The MIDI cable is not connected properly.

- With the power turned off, reconnect the DR-202’s MIDI OUT connector and the MIDI IN connector of the external MIDI device (p.10, 62).

Cause: Output Assign is set to INT, and the performance information is not being sent to the external MIDI device.

- Press [MIDI] to call up the MIDI Mode screen. Press the [▶] cursor key to display Output Assign, and rotate the VALUE dial to change the setting to INT or INT+EXT (p. 59, 60).

Cause: MIDI channels do not match, so the external MIDI device does not recognize the performance information being sent.

- Press [MIDI] to call up the MIDI Mode screen. Press the [▶] cursor key to display the MIDI Channel, and rotate the VALUE dial to change the setting. Refer to the owner’s manual for the external MIDI device you are connecting for procedures related to setting that device’s MIDI channel (p.58, 60).

Cause: The external MIDI device cannot produce sounds because Note Numbers are not in agreement.

- Check the Note Numbers that the external MIDI device can use to play sounds and the Note Numbers the DR-202 sends (refer to documentation, particularly each device’s MIDI Implementation Chart) (p.34).

Problem: MIDI Program Change messages are not being received.

Cause: The MIDI Program Change Switch is set to OFF, so the information is not being sent and received.

- Press [MIDI] to call up the MIDI Mode screen. Press the [▶] cursor key to display the MIDI Program Change Switch, and rotate the VALUE dial to change the setting to ON (p.58, 60).

Problem: MIDI Volume messages have no effect on the volume.

Cause: The MIDI Volume Switch is set to OFF, so the information is not being received.

- Press [MIDI] to call up the MIDI Mode screen. Press the [▶] cursor key to display the MIDI Volume Switch, and rotate the VALUE dial to change the setting to ON (p. 58, 60).

Problem: MIDI Expression messages have no effect on the volume.

Cause: The MIDI Expression Switch is set to OFF, so the information is not being received.

- Press [MIDI] to call up the MIDI Mode screen. Press the [▶] cursor key to display the MIDI Volume Switch, and rotate the VALUE dial to change the setting to ON (p. 59, 60).

Problem: Control Change messages (except for Volume messages and Expression messages) have no effect on the corresponding parameters.

Cause: The MIDI Control Change Switch is set to OFF, so the information is not being received.

- Press [MIDI] to call up the MIDI Mode screen. Press the [▶] cursor key to display the MIDI Control Change Switch, and rotate the VALUE dial to change the setting to ON (p.59, 60).

Problem: MIDI messages received at the MIDI IN connector are not being output from MIDI OUT.

Cause: The MIDI THRU Switch is set to OFF, so MIDI messages received at the MIDI IN connector are not output from MIDI OUT.

- Press [MIDI] to call up the MIDI Mode screen. Press the [▶] cursor key to display the MIDI THRU Switch, and rotate the VALUE dial to change the setting to ON (p. 59, 60).

Problem: System Exclusive messages are not being received.

Cause: The System Exclusive Device ID number and the ID number of the receiving device are not in agreement, so the information cannot be received.

- Press [MIDI] to call up the MIDI Mode screen. Press the [▶] cursor key to display the System Exclusive ID Number, and rotate the VALUE dial to change the setting (p.59, 60).

Cause: The information cannot be received because a performance of a pattern or song is in progress on the receiving device.

- Stop performance of the pattern or song, then resend the System Exclusive messages from the beginning.

Cause: The information cannot be received because the receiving device is running the Bulk Dump procedure.

- Stop the Bulk Dump procedure, then resend the System Exclusive messages from the beginning.

Problem: The pitch cannot be raised properly with Portamento or Pitch Bend messages sent from an external MIDI device.

Cause: The pitch of some bass instruments can be raised only to a certain level.

- Use a different bass instrument.

Problem: Cannot Start or Stop recording correctly with a Start/Stop message from an external MIDI device, during Realtime Recording.

Cause: An interval between Start and Stop message is extremely short.

- Please make the interval to be at least one measure long.

Error Message List

Error messages are displayed when there is an error in operation or when an operation cannot be processed correctly. Take appropriate measures as indicated by the error message displayed.

Battery Low !

The power in the DR-202's operating batteries (six dry batteries; LR6(AA) type) is nearly used up.

→ Replace with new batteries.

Backup Battery Low !

The DR-202's backup battery power is nearly used up (this error message appears when the power is switched on).

→ Immediately contact your dealer or nearest Roland service center to obtain replacement backup batteries.

MIDI Off Line !

There is a problem with the MIDI cable connection.

→ Check to make sure the cable has not been pulled out or is not shorted.

MIDI Buffer Full !

Too many MIDI messages are being received at one time for the DR-202 to process them.

→ Reduce the number of MIDI messages received by the DR-202.

Checksum Error !

The System Exclusive checksum value that was received is incorrect.

→ Correct the checksum value.

Memory Full !

User memory is insufficient for saving performance information in a pattern, or for copying a song or pattern.

User memory is insufficient for Realtime recording or Step recording.

→ If necessary, use Bulk Dump to save data to an external MIDI device, then delete any unneeded patterns or songs.

Memory Damaged !

The DR-202's memory may be corrupted.

→ Try carrying out Factory Reset (refer to Quick Start). If this does not resolve the problem, contact your nearest Roland service center.

Too Much data !

There is an excessive amount of performance data, so the unit cannot carry out recording or playback.

→ Remedy the situation as follows:

1. Get into the Recording Standby mode again.
2. Lower the BPM (lower the tempo).
3. Try to reduce the amount of performance data.

Parameter List

Kits

KIT NAME	Kit Name	Maximum 11 Characters
INST	Instrument	Refer to the Instrument List (p.70)

■ Instruments

LEVEL	Level	0–15
PITCH	Pitch	-100–+100
PAN	Panning	Left 7-Center-Right 7
REV/DLY SEND	Reverb/Delay Send Level	0–100
FLANGER SEND	Flanger Send Level	0–100
CUTOFF	Cutoff	-50–+50
RESONANCE	Resonance	-50–+50
DECAY	Decay	-50–+50

■ Effects

REVERB/DELAY TYPE	Reverb/Delay Type	Small Room, Studio, Club, Lounge, Large Hall, Dark Hall, Plate 1, Plate 2, Stereo Delay, Pan Delay
REVERB TIME	Reverb Time	0–100
REVERB E.LEVEL	Reverb Effect Level	0–127
DELAY TIME	Delay Time	5–450 ms, (♩♩) half-note triplets, (♩.) dotted quarter notes, (♩) quarter notes, (♩♩) quarter-note triplets, (♩.) dotted eighth notes, (♩) eighth notes, (♩♩) eighth-note triplets, (♩.) dotted sixteenth notes, (♩) sixteenth notes, (♩♩) sixteenth-note triplets
DELAY E.LEVEL	Delay Effect Level	0–100
DELAY FEEDBACK	Delay Feedback	0–127
FLANGER TYPE	Flanger Type	Jet Flanger, Soft Flanger, Hard Flanger, Cold Flanger
FLANGER RATE	Flanger Rate	0–100
FLANGER E.LEVEL	Flanger Effect Level	0–127

Patterns

STYLE	Style	Refer to the Preset Pattern List (p.72)
PATTERN	Pattern	Refer to the Preset Pattern List (p.72)
PATTERN NAME	Pattern Name	Maximum 8 Characters
Q (QUANTIZE)	Quantize	(♩) Quarter Note, (♩♩) Quarter-note Triplet, (♩) Eighth Note, (♩♩) Eighth-note Triplet, (♩) Sixteenth Note, (♩♩) Sixteenth-note Triplet, (♩) Thirty-second Note, (♩♩) Thirty-second-note Triplet, Hi (4 x 96 = 384th Note)
GROOVE TEMPLATE	Groove Template	Refer to the Groove Template List (p.79)
M (MEASURE)	Number of Measure	1–8
B (BEAT)	Beat	1/4, 2/4, 3/4, 4/4
TICK TIME	Tick Time	1–100 – 4–495 (four measures, four beats per measure)
NOTE	Note Name	C, C#, D, D#, E, F, F#, G, G#, A, A#, B
OCT (OCTAVE)	Octave Shift	0–7

G (GATE TIME)	Gate Time	0001–2047
ACC, A (ACCENT)	Accent	1–8
SHIFT	Time Shift	-12→+12
PORTAMENTO	Portamento	OFF, ON
PORTAMENTO T.	Portamento Time	0–127

■ Setup Information

KIT	Kit	Refer to the Preset Kit List (p.71)
BPM	Standard Tempo (RECOMMEND)	40.0–250.0
ROLL TYPE	Roll Type	Refer to the Roll Type List (p.71)
ROLL SPEED	Roll Speed	0–127
MUTE	Mute	O, X

Songs

SONG NAME	Song Name	Maximum 12 Characters
INIT BPM	Initial BPM (Tempo)	40.0–250.0, RECOMMEND

UTILITY

LCD CONTRAST	LCD Contrast	0–10
FOOT SWITCH ASSIGN	Foot Switch Assign	StartStop, ContStop, KICK1, KICK2, SNARE1, SNARE2, CLOSED HH, OPEN HH, RIDE, CLASH, PERC1, PERC2, HIT1, HIT2, HIT3
AVAIL MEMORY	Available Memory	0–100%
Strong Beat INST	Strong Beat Instrument	808RIM, 909RIM, Click, Drystk, TriaOp, TriaMt, Claves
Weak Beat INST	Weak Beat Instrument	808RIM, 909RIM, Click, Drystk, TriaOp, TriaMt, Claves
Strong Beat LEVEL	Strong Beat Level	0–15
Weak Beat LEVEL	Weak Beat Level	0–15

MIDI

CHANNEL DRUM	MIDI Channel (Drum Part)	1–16
CHANNEL BASS	MIDI Channel (Bass Part)	1–16
CHANNEL EXT	MIDI Channel (External Part)	1–16
PROG CHG SW	MIDI Program Change Switch	OFF, ON
VOLUME SW	MIDI Volume Switch	OFF, ON
VOLUME DRUM	MIDI Volume (Drum Part)	0–127
VOLUME BASS	MIDI Volume (Bass Part)	0–127
VOLUME EXT	MIDI Volume (External Part)	0–127
EXPRESSION SW	MIDI Expression Switch	OFF, ON
CONTROL CHG SW	MIDI Control Change Switch	OFF, ON
THRU SW	MIDI Thru Switch	OFF, ON
OUT ASSIGN DRUM	Output Assign (Drum Part)	INT, EXT, INT+EXT
OUT ASSIGN BASS	Output Assign (Bass Part)	INT, EXT, INT+EXT
SYNC MODE	Synchro Mode	INT, MIDI, AUTO, REMOTE
SYS EXCLUS	System Exclusive Device ID Number	17–32
BULK DUMP	MIDI Bulk Dump	All, SongPattern, Kit, UtilityMIDI

Instrument List

■ BASS

■ DRUM

No.	Name	Voice	No.	Name	Voice	No.	Name	Voice	No.	Name	Voice	No.	Name	Voice
00	FingB1	2	49	808 K1	1	101	ElecS1	1	153	909Tm3	2	205	SrdOPL	1
01	FingB2	2	50	808 K2	2	102	StandS	2	154	DRTom1	2	206	Tamb1	1
02	FingB3	2	51	808 K3	2	103	Fat1 S	2	155	DRTom2	2	207	Tamb2	1
03	PickB1	2	52	909 K1	2	104	HpRm S	1	156	DRTom3	2	208	TimblH	1
04	PickB2	2	53	909 K2	2	105	RegaeS	2	157	ElecT1	2	209	TimblL	1
05	SlapB1	2	54	606DSK	2	106	R8tapS	1	158	ElecT2	2	210	TriaOp	1
06	SlapB2	2	55	707 K	2	107	Brasrl	1	159	ElecT3	2	211	TriaMt	1
07	SlapB3	2	56	AbstrK	2	108	OldEIS	2	160	OLDTm1	1	212	GuiroS	1
08	AcosB1	2	57	Jazz K	2	109	JazzS2	2	161	OLDTm2	1	213	GuiroL	1
09	AcosB2	2	58	Cave K	2	110	LightS	2	162	808 CH	1	214	Claves	1
10	WoodB1	2	59	BriteK	2	111	78scrS	2	163	909 CH	1	215	AgogoH	1
11	WoodB2	2	60	BreakK	2	112	FatdsS	2	164	707CHH	1	216	AgogoL	1
12	FrtlsB	2	61	PillwK	2	113	ElecS2	2	165	78 CHH	1	217	MtCuia	1
13	Acid B	2	62	HiHpK1	2	114	RitRmS	2	166	ElecCH	1	218	OpCuia	1
14	DistTB	2	63	HiHpK2	2	115	WoodyS	2	167	HpHpCH	1	219	Bell	1
15	SqswTB	2	64	HiHpK3	2	116	Tamb S	2	168	NOIZCH	2	220	WhislL	1
16	DsinTB	2	65	Dist K	2	117	HpFatS	2	169	JnglHH	1	221	WhislS	1
17	DublTB	2	66	ElectK	2	118	Slap S	2	170	RelCH1	1	222	Bounce	1
18	SqrTB	2	67	MG bdK	1	119	DrmRmS	2	171	RelCH2	1	223	lrmDor	1
19	ResoTB	2	68	PB300K	2	120	LooseS	2	172	Pop CH	1	224	ComeOn	1
20	DsawTB	2	69	TightK	2	121	Cool S	2	173	808 OH	1	225	TBShot	1
21	Saw TB	2	70	JnglK1	2	122	77mt S	2	174	909 OH	1	226	HpHpHT	1
22	AcosTB	2	71	JnglK2	2	123	TecRmS	2	175	707OHH	1	227	PinkHT	1
23	TBPadB	2	72	Scrbdk	1	124	Clap S	2	176	HpHpOH	1	228	WhitHT	1
24	SolidB	2	73	Gate K	2	125	Perc S	2	177	NOIZOH	2	229	BackHT	1
25	HouseB	2	74	Roll K	1	126	Slit S	2	178	RelOH1	1	230	Philly	1
26	TechnB	2	75	SmashK	2	127	JBeatS	2	179	RelOH2	1	231	RecrdN	1
27	SineB1	2	76	Dark K	2	128	BreakS	2	180	Pop OH	1	232	Scrt 1	1
28	SineB2	2	77	99TecK	2	129	808RIM	1	181	BrekOH	1	233	Scrt 2	1
29	BreakB	2	78	Lofi K	2	130	909RIM	1	182	PdlCHH	1	234	Scrt 3	1
30	Soul B	1	79	KnockK	2	131	PB30Rm	1	183	808Cym	1	235	Scrt 4	1
31	OrganB	2	80	808 S1	1	132	RagaRm	2	184	909Cym	1	236	Scrt 5	1
32	5thOgB	2	81	808 S2	1	133	Click	1	185	CrashC	1	237	Scrt 6	1
33	ResOgB	2	82	909 S1	1	134	Drystk	1	186	DrumnC	2	238	Scrt 7	1
34	101 B1	2	83	909 S2	2	135	6DSCLP	1	187	SplshC	1	239	Scrt 8	1
35	101 B2	2	84	606DSS	2	136	88DSCP	1	188	707RdC	1	240	WindNZ	1
36	101 B3	2	85	707 S	2	137	909CLP	1	189	909RdC	1	241	CowHit	2
37	MG B1	2	86	CR78 S	1	138	RealCP	1	190	RideC1	1	242	TeckBP	2
38	MG B2	2	87	HpdisS	2	139	ClapCP	2	191	RideC2	1	243	Beep	1
39	SquarB	2	88	East S	1	140	FnkyCP	1	192	RidBIC	1	244	Bombb	2
40	Saw B1	2	89	Pop S	2	141	FunkCP	1	193	808Cow	1	245	MGBLIR	1
41	Saw B2	2	90	AbstrS	1	142	DwnCLP	1	194	Cowbel	1	246	MGBLP1	1
42	Saw B3	2	91	JazzS1	1	143	SnarCP	2	195	808Cng	1	247	MGBLP2	1
43	Hi-PFB	2	92	HipHpS	2	144	ShtCLP	2	196	BongoH	2	248	REZNIZ	1
44	ElecB1	2	93	UrbanS	2	145	AtcCLP	2	197	BongoL	2	249	RevClp	1
45	ElecB2	2	94	Drmn S	2	146	Snap	1	198	CongaH	2	250	RevSnr	1
46	SwPnkB	2	95	JnglS1	2	147	FngSNP	1	199	CongaL	2	251	Rev HH	1
47	NoizB1	2	96	JnglS2	2	148	808Tm1	2	200	CongMt	1	252	RevCym	1
48	NoizB2	2	97	HeadzS	2	149	808Tm2	2	201	Marcas	1	253	RevTmb	1
			98	Scrchs	1	150	808Tm3	2	202	Shaker	1	254	RevFx1	1
			99	Rock S	2	151	909Tm1	2	203	SurdMt	1	255	RevFx2	1
			100	BigBtS	2	152	909Tm2	2	204	SurdOP	1			

Preset Kit List

No.	Name
P000	HipHop 1
P001	HipHop 2
P002	HipHop 3
P003	HipHop 4
P004	HipHop 5
P005	HipHop 6
P006	HipHop 7
P007	HipHop 8
P008	HipHop 9
P009	HipHop 10
P010	HipHop 11
P011	HipHop 12
P012	HipHop 13
P013	HipHop 14
P014	HipHop 15
P015	HipHop 16
P016	HipHop 17
P017	HipHop 18
P018	HipHop 19
P019	HipHop 20
P020	HipHop 21
P021	HipHop 22
P022	HipHop 23
P023	HipHop 24
P024	HipHop 25
P025	HipHop 26
P026	HipHop 27
P027	HipHop 28
P028	BASS
P029	Abstract 1
P030	Abstract 2
P031	Abstract 3
P032	Abstract 4
P033	Abstract 5
P034	Abstract 6
P035	TR-808 1
P036	TR-808 2
P037	TR-909
P038	TR-707&78
P039	606 DST
P040	House 1
P041	House 2
P042	House 3
P043	House 4
P044	House 5

No.	Name
P045	House 6
P046	House 7
P047	House 8
P048	House 9
P049	Eurobeat
P050	Jungle 1
P051	Jungle 2
P052	Jungle 3
P053	Jungle 4
P054	Drum'n'Bs 1
P055	Drum'n'Bs 2
P056	Drum'n'Bs 3
P057	Drum'n'Bs 4
P058	Drum'n'Bs 5
P059	Drum'n'Bs 6
P060	Drum'n'Bs 7
P061	Drum'n'Bs 8
P062	Drum'n'Bs 9
P063	Drum'n'Bs10
P064	Drum'n'Bs11
P065	Drum'n'Bs12
P066	Techno 1
P067	Techno 2
P068	Techno 3
P069	Techno 4
P070	Techno 5
P071	Techno 6
P072	Techno 7
P073	Techno 8
P074	Techno 9
P075	Electro 1
P076	Electro 2
P077	Hardcore
P078	Industrial1
P079	Industrial2
P080	Ambient 1
P081	Ambient 2
P082	Acid Jazz 1
P083	Acid Jazz 2
P084	Acid Jazz 3
P085	Acid Jazz 4
P086	Acid Jazz 5
P087	Acid Jazz 6
P088	Acid Jazz 7
P089	Acid Jazz 8

No.	Name
P090	Acid Jazz 9
P091	Acid Jazz10
P092	Acid Jazz11
P093	Acid Jazz12
P094	Acid Jazz13
P095	Latin 1
P096	Latin 2
P097	Latin 3
P098	Latin 4
P099	Latin 5
P100	Latin 6
P101	Latin 7
P102	Latin 8
P103	Big Beat 1
P104	Big Beat 2
P105	Big Beat 3
P106	Big Beat 4
P107	Big Beat 5
P108	Rock 1
P109	Rock 2
P110	Standard 1
P111	Standard 2
P112	Hard Rock
P113	Metal
P114	Fusion 1
P115	Fusion 2
P116	Latin Rock
P117	Jazz 1
P118	Jazz 2
P119	Jazz 3
P120	R&B
P121	Funk 1
P122	Funk 2
P123	Funk 3
P124	Ballade
P125	Reggae
P126	Pop
P127	Percussion

Preset Pattern List

■ HIP-HOP 1

No.	Genre	BPM	Measure	Kit No.
01	Hip Hop East	95	2	P002
02	Hip Hop East	92	4	P000
03	Hip Hop East	92	4	P000
04	Hip Hop East	90	2	P002
05	Hip Hop East	90	2	P002
06	Hip Hop East	93	4	P001
07	Hip Hop East	93	4	P001
08	Hip Hop East	100	2	P000
09	Hip Hop East	95	2	P000
10	Hip Hop East	97	2	P001
11	Hip Hop East	97	2	P001
12	Hip Hop East	91	4	P006
13	Hip Hop West	100	4	P005
14	Hip Hop West	100	4	P005
15	Hip Hop West	105	4	P005
16	Hip Hop West	98	2	P006
17	Hip Hop West	98	2	P006
18	Hip Hop Old School	102	2	P017
19	Hip Hop Old School	102	2	P017
20	Hip Hop Old School	100	2	P015
21	Hip Hop Old School	100	2	P015
22	Hip Hop Old School	110	2	P016
23	Hip Hop Old School	110	4	P016
24	Hip Hop Old School	110	2	P017
25	Hip Hop Old School	110	2	P017
26	G.Funk	91	4	P007
27	G.Funk	91	4	P007
28	G.Funk	96	4	P007
29	G.Funk	96	4	P007
30	G.Funk	91	4	P007
31	G.Funk	91	4	P007
32	Hip Hop Rock	98	4	P020
33	Hip Hop Rock	110	4	P019
34	Hip Hop Rock	110	4	P019
35	Hip Hop	110	4	P025
36	Hip Hop	110	4	P025
37	Hip Hop	92	4	P024
38	Hip Hop	100	2	P022
39	Hip Hop	100	2	P022
40	Hip Hop	113	2	P031
41	Hip Hop	113	2	P031
42	Hip Hop Jazz	105	4	P126
43	Hip Hop	115	2	P010
44	Hip Hop	115	4	P010
45	Hip Hop	103	2	P119
46	Hip Hop	102.5	4	P123
47	Hip Hop	102.5	4	P123
48	Hip Hop	102.5	2	P002
49	Hip Hop	102.5	2	P002

■ HIP-HOP 2

No.	Genre	BPM	Measure	Kit No.
01	Hip Hop	115	2	P000
02	Hip Hop	115	2	P000
03	Hip Hop	122	4	P009
04	Hip Hop	122	2	P009
05	New Jack Swing	105	4	P012
06	New Jack Swing	105	4	P012
07	New Jack Swing	100	4	P013
08	Hip Hop Old School	121	4	P036
09	Hip Hop Old School	121	4	P036
10	Hip Hop Old School	120	2	P016
11	Hip Hop Old School	120	2	P016
12	Hip Hop Old School	128	4	P018
13	Hip Hop Old School	128	4	P018
14	Hip Hop Old School	130	4	P018
15	Hip Hop Old School	121	4	P018
16	Hip Hop Old School	121	4	P018
17	Hip Hop Old School	100	4	P018
18	Hip Hop Old School	128	4	P018
19	Hip Hop Old School	128	4	P018
20	BASS	148	4	P055
21	BASS	148	2	P055
22	BASS	140	2	P003
23	BASS	140	2	P003
24	BASS	140	8	P028
25	Hip Hop Rock	120	4	P020
26	Hip Hop Rock	119	4	P008
27	Hip Hop Rock	119	4	P008
28	Hip Hop	110	2	P003
29	Hip Hop	110	2	P003
30	Hip Hop Jazz	101	8	P011
31	Hip Hop Jazz	125	4	P117
32	Hip Hop Jazz	125	4	P117
33	RaggaHipHop	177	4	P014
34	RaggaHipHop	177	4	P014

■ HIP-HOP 3

No.	Genre	BPM	Measure	Kit No.
01	Hip Hop East	79	2	P021
02	Hip Hop East	85	2	P023
03	Hip Hop East	85	2	P023
04	Hip Hop East	77	2	P032
05	Hip Hop East	77	2	P032
06	Hip Hop East	93	2	P023
07	Hip Hop East	93	2	P023
08	Hip Hop West	75	2	P004
09	Hip Hop West	75	2	P004
10	Hip Hop	90	2	P023
11	Abstract	82	8	P030
12	Abstract	82	8	P030
13	Abstract	82	4	P032
14	Abstract	82	4	P032
15	Abstract	80	2	P080
16	Abstract	80	2	P080
17	Abstract	55	2	P029
18	Abstract	55	2	P029
19	Trip Hop	65	4	P029
20	Trip Hop	90	4	P036
21	Trip Hop	80	4	P030
22	Trip Hop	80	4	P030
23	Trip Hop	81	4	P030
24	Trip Hop	81	4	P030
25	Trip Hop	91	4	P030
26	Trip Hop	91	4	P030
27	Trip Hop	60	2	P029
28	Trip Hop	75	2	P029
29	Hip Hop	83	2	P008
30	Hip Hop	83	2	P008
31	Hip Hop Soul	70	2	P027
32	Hip Hop Soul	80	2	P026
33	Hip Hop Soul	64	4	P036
34	Hip Hop Soul	64	4	P036
35	Hip Hop Jazz	78	2	P012
36	Hip Hop Jazz	78	2	P012

■ JUNGLE

No.	Genre	BPM	Measure	Kit No.
01	Jungle	160	2	P053
02	Jungle	160	2	P053
03	Jungle	160	2	P052
04	Jungle	160	2	P052
05	Jungle	172	2	P053
06	Jungle	172	2	P053
07	Jungle	165	2	P052
08	Jungle	165	2	P052
09	Jungle	165	4	P051
10	Jungle	165	4	P051
11	Jungle	174	4	P051
12	Jungle	174	4	P051
13	Jungle	168	4	P050
14	Jungle	158	2	P050
15	Jungle	158	4	P050
16	Jungle	158	8	P050

Preset Pattern List

■ DRUM'N'BASS

No.	Genre	BPM	Measure	Kit No.
01	Drum'n'Bass	170	2	P058
02	Drum'n'Bass	170	2	P058
03	Drum'n'Bass	160	4	P055
04	Drum'n'Bass	160	4	P055
05	Drum'n'Bass	160	4	P055
06	Drum'n'Bass	160	4	P055
07	Drum'n'Bass	180	4	P057
08	Drum'n'Bass	165	4	P057
09	Drum'n'Bass	170	2	P062
10	Drum'n'Bass	170	2	P062
11	Drum'n'Bass	180	2	P063
12	Drum'n'Bass	180	2	P063
13	Drum'n'Bass	165	4	P050
14	Drum'n'Bass	180	2	P058
15	Drum'n'Bass	180	2	P058
16	Drum'n'Bass	170	2	P060
17	Drum'n'Bass	170	2	P060
18	Drum'n'Bass	150	4	P060
19	Drum'n'Bass	150	4	P060
20	Drum'n'Bass	147	2	P063
21	Drum'n'Bass	147	2	P063
22	Drum'n'Bass	170	4	P054
23	Drum'n'Bass	165	4	P054
24	Drum'n'Bass	165	4	P069
25	Drum'n'Bass	156	4	P050
26	Drum'n'Bass	161	4	P050
27	Drum'n'Bass	165	4	P050
28	Drum'n'Bass	161	2	P059
29	Drum'n'Bass	161	2	P059
30	Drum'n'Bass	180	2	P061
31	Drum'n'Bass	180	2	P061
32	Drum'n'Bass	165	2	P062
33	Drum'n'Bass	165	2	P062
34	Drum'n'Bass	160	2	P059
35	Drum'n'Bass	160	2	P059
36	Drum'n'Bass	165	4	P056
37	Drum'n'Bass	165	4	P056
38	Drum'n'Bass	165	4	P056
39	Drum'n'Bass	165	4	P056
40	Drum'n'Bass	170	4	P056
41	Drum'n'Bass	170	4	P056
42	Drum'n'Bass	165	4	P056
43	Drum'n'Bass	165	4	P056
44	Drum'n'Bass	170	2	P064
45	Drum'n'Bass	170	2	P064
46	Drum'n'Bass	160	2	P064
47	Drum'n'Bass	160	2	P064
48	Drum'n'Bass	180	2	P065
49	Drum'n'Bass	180	2	P065
50	Drum'n'Bass	160	2	P065
51	Drum'n'Bass	160	2	P065

■ TECHNO

No.	Genre	BPM	Measure	Kit No.
01	Minimal	130	4	P066
02	Minimal	130	4	P066
03	Minimal	130	4	P066
04	Minimal	130	4	P066
05	Minimal	140	4	P066
06	Minimal	140	4	P066
07	Minimal	129	4	P066
08	Minimal	129	4	P066
09	Minimal	139	4	P066
10	Minimal	139	4	P066
11	Minimal	140	2	P070
12	Minimal	140	2	P070
13	Minimal	145	2	P070
14	Minimal	145	2	P070
15	Detroit Techno	125	2	P071
16	Detroit Techno	125	2	P071
17	Detroit Techno	120	2	P071
18	Detroit Techno	120	2	P071
19	Detroit Techno	140	4	P067
20	Electro	130	2	P067
21	Electro	119	4	P067
22	Electro	130	2	P076
23	Electro	130	2	P076
24	Trance	145	4	P073
25	Trance	138	4	P073
26	Trance	143	4	P073
27	Trance	145	4	P073
28	Trance	142	4	P074
29	Trance	136	4	P074
30	NU-NRG	150	2	P068
31	NU-NRG	152	4	P068
32	Hardcore	205	2	P077
33	Hardcore	205	2	P077
34	Hardcore	175	4	P069
35	Hardcore	185	4	P074
36	Industrial	150	2	P078
37	Industrial	150	2	P078
38	Industrial	140	2	P078
39	Industrial	140	2	P078
40	Rave	120	2	P072
41	Rave	120	2	P072
42	Rave	130	2	P072
43	Rave	130	2	P072
44	Rave	120	2	P044
45	Rave	120	2	P044
46	Ambient	110	2	P080
47	Ambient	110	2	P080
48	Ambient	104	6	P081
49	Ambient	104	6	P081
50	Ambient	104	2	P081
51	Ambient	104	2	P081

■ HOUSE

No.	Genre	BPM	Measure	Kit No.
01	House	128	2	P042
02	House	128	2	P042
03	House	128	2	P041
04	House	128	2	P041
05	House	128	2	P041
06	House	128	2	P041
07	House	130	2	P049
08	House	130	2	P049
09	House	123	4	P040
10	House	123	4	P040
11	House	123	4	P040
12	House	123	4	P040
13	House	128	4	P074
14	House	130	4	P040
15	Acid House	140	2	P045
16	Acid House	140	2	P045
17	Acid House	135	2	P045
18	Acid House	135	2	P045
19	Acid House	140	2	P046
20	Acid House	140	2	P046
21	Acid House	140	2	P046
22	Acid House	140	2	P046
23	Latin House	120	4	P048
24	Latin House	110	4	P093
25	Latin House	115	4	P094
26	Latin House	115	2	P043
27	Latin House	122	2	P047
28	Latin House	122	2	P047
29	Latin House	122	4	P047
30	Latin House	122	4	P047
31	Latin House	120	2	P042
32	Latin House	120	2	P042
33	Eurobeat	155	4	P049
34	Eurobeat	155	4	P049
35	Eurobeat	155	4	P049
36	Eurobeat	155	2	P049

■ ACIDJAZZ

No.	Genre	BPM	Measure	Kit No.
01	Acid Jazz	132	4	P091
02	Acid Jazz	132	4	P091
03	Acid Jazz	120	4	P092
04	Acid Jazz	118	4	P091
05	Acid Jazz	117	4	P092
06	Acid Jazz	117	4	P092
07	Acid Jazz	97	2	P087
08	Acid Jazz	104	2	P082
09	Acid Jazz	104	2	P084
10	Acid Jazz	95	2	P088
11	Acid Jazz	95	4	P088
12	Acid Jazz	97	2	P011
13	Acid Jazz	97	2	P011
14	Acid Jazz	97	4	P086
15	Acid Jazz	97	4	P086
16	Acid Jazz	80	4	P085
17	Acid Jazz	119	2	P082
18	Acid Jazz	119	4	P082
19	Acid Jazz	124	4	P091
20	Acid Jazz	124	4	P091
21	Acid Jazz	92	2	P091
22	Acid Jazz	92	4	P091
23	Acid Jazz	83	2	P083
24	Acid Jazz	95	4	P093
25	Acid Jazz	120	4	P010
26	Acid Jazz	120	2	P010
27	Acid Jazz	120	2	P093
28	Acid Jazz	114	4	P089
29	Acid Jazz	114	2	P089
30	Acid Jazz	130	2	P089
31	Acid Jazz	130	2	P089
32	Acid Jazz	116	2	P090
33	Acid Jazz	116	4	P090
34	Acid Jazz	105	4	P093
35	Acid Jazz	99	2	P094
36	Acid Jazz	103	4	P089
37	Acid Jazz	103	4	P089
38	Acid Jazz	90	2	P010
39	Acid Jazz	90	4	P010

Preset Pattern List

■ LATIN

No.	Genre	BPM	Measure	Kit No.
01	Salsa	101	4	P127
02	Salsa	101	4	P097
03	Salsa	101	2	P097
04	Salsa	89	4	P097
05	Salsa	89	4	P097
06	Salsa	85	4	P097
07	Salsa	112	4	P095
08	Merengue	145	4	P099
09	Merengue	145	4	P098
10	Merengue	130	4	P098
11	Merengue	130	4	P098
12	Rhumba	109	4	P100
13	Rhumba	145	4	P100
14	Rhumba	73	4	P100
15	Rhumba	69	4	P100
16	Samba	138	8	P101
17	Samba	138	8	P101
18	Samba	120	4	P008
19	Samba	120	4	P008
20	Mambo	220	4	P102
21	Mambo	220	4	P102
22	Bossa Nova	139	2	P118
23	Bossa Nova	139	2	P118
24	Cha Cha	84	4	P096

■ ROCK

No.	Genre	BPM	Measure	Kit No.
01	BigBeat	120	4	P103
02	BigBeat	120	4	P103
03	BigBeat	125	4	P103
04	BigBeat	125	4	P103
05	BigBeat	135	4	P106
06	BigBeat	135	2	P106
07	BigBeat	110	4	P104
08	BigBeat	110	4	P104
09	BigBeat	130	2	P107
10	BigBeat	130	4	P107
11	BigBeat	105	2	P105
12	BigBeat	105	2	P105
13	BigBeat	137	2	P019
14	BigBeat	128	4	P105
15	8beat Rock	113	4	P110
16	8beat Rock	105	2	P110
17	16beat Rock	110	4	P020
18	16beat Rock	125	4	P112
19	Grunge Rock	174	2	P112
20	Grunge Rock	174	2	P112
21	Hard Rock	161	2	P113
22	Hard Rock	161	4	P113
23	Metal Rock	180	2	P112
24	Metal Rock	180	4	P112
25	Fusion	140	8	P114
26	Fusion	98	4	P115
27	Progressive Rock	135	5	P109
28	Progressive Rock	135	5	P109
29	Shuffle	140	2	P112
30	Shuffle	140	4	P112
31	Halftime Shuffle	87	2	P112
32	Halftime Shuffle	87	2	P112
33	Latin Rock	125	2	P116
34	Latin Rock	125	4	P116

■ OTHER

No.	Genre	BPM	Measure	Kit No.
01	Funk	122	4	P121
02	Funk	129	2	P121
03	R&B	119	4	P120
04	R&B	108	4	P120
05	Reggae	180	4	P014
06	Reggae	180	4	P014
07	Reggae	90	2	P125
08	Reggae	90	2	P125
09	Reggae	88	2	P125
10	Reggae	88	2	P125
11	Ballade	88	4	P124
12	Ballade	88	4	P124
13	12/8 Ballade	80	4	P111
14	12/8 Ballade	70	2	P111
15	Jazz	220	8	P118
16	Jazz	220	8	P118
17	Jazz	160	8	P118
18	Jazz	160	8	P118
19	Jazz	90	4	P118
20	Jazz	90	4	P118
21	Waltz	158	8	P118
22	Waltz	158	8	P118
23	Blues	125	2	P111
24	Blues	55	2	P111
25	Rockabilly	245	4	P126
26	Rockabilly	245	4	P126
27	Country	143	2	P111
28	Country	143	4	P111
29	Metronome	120	1	P096
30	Metronome	120	1	P096

Roll Types List

No.	Name	Comment
00	Flat	This rolls for a fixed period of time
01	Cresc	The volume of the roll increases gradually.
02	Decresc	The volume of the roll decreases gradually.
03	Up	The pitch of the roll decreases gradually.
04	Dow	The pitch of the roll decreases gradually.
05	Up Cresc	The volume and pitch both increase gradually.
06	Down Cresc	The volume increases while the pitch decreases gradually.
07	Flat Dir	It keeps rolling continuously.
08	Cresc Alt	The volume increases and decrease, then increases and decreases again and again.
09	Cresc Dir1	Repetitions of a gradual volume increase.
10	Cresc Dir2	The volume increases gradually, then it rolls repeatedly.
11	Decresc Alt	The volume decreases and increases, then decreases and increases again and again.
12	Decresc Dir	Repetitions of a gradual volume decrease.
13	Up Alt	The pitch increases and decreases, then increases and decreases again and again.
14	Up Dir1	Repetitions of a gradual pitch increase.
15	Up Dir 2	The pitch increases gradually, then it rolls.
16	Up Dir 3	The volume increases while the pitch decreases, then it rolls repeatedly.
17	Down Alt	The pitch decreases and increases, then decreases and increases again and again.
18	Down Dir 1	Repetitions of gradual pitch increase.
19	Down Dir 2	The pitch increases, then it rolls continuously.
20	Down Dir 3	The volume increases, while the pitch decreases, then it rolls continuously.
21	Lo-Fi 1	The sound gradually becomes darker.
22	Lo-Fi 2	The sound is slightly unusual and gradually becomes darker.
23	Lo-Fi 3	The sound is unusual and gradually becomes darker.
24	Hi-Fi 1	The sound gradually becomes brighter.
25	Hi-Fi 2	The sound is slightly unusual and gradually becomes brighter.
26	Hi-Fi 3	The sound is unusual and gradually becomes brighter.
27	Lo-Fi 1 Alt	Repetitions if gradual tone change from brighter to darker.
28	Lo-Fi 2 Alt	The sound us slightly unusual and alternately becomes darker and brighter.
29	Lo Fi 3 Alt	The sound is unusual and alternately becomes darker and brighter.
30	Lo-Fi1 Dir 1	Repetitions of a gradual tone change to darker.
31	Lo-Fi2 Dir 1	The sound is slightly unusual and gradually becomes darker repeatedly.
32	Lo-Fi3 Dir 1	The sound is unusual and gradually becomes darker repeatedly.

No.	Name	Comment
33	Lo-Fi1 Dir 2	The sound gradually becomes darker and rolls repeatedly.
34	Lo-Fi2 Dir 2	The sound is slightly unusual and gradually becomes darker, then it rolls repeatedly.
35	Lo-Fi3 Dir 2	The sound is unusual and gradually becomes darker, then it rolls repeatedly.
36	Hi-Fi 1 Alt	Repetitions of tone change from darker to brighter.
37	Hi-Fi 2 Alt	The sound is slightly unusual and alternately becomes brighter and darker repeatedly.
38	Hi-Fi 3 Alt	The sound is unusual and alternately becomes brighter and darker repeatedly.
39	Hi-Fi 1 Dir 1	Repetitions of tone changes from dark to brighter.
40	Hi-Fi 2 Dir 1	The sound is slightly unusual and gradually becomes brighter repeatedly.
41	Hi-Fi 3 Dir 1	The sound is unusual and gradually becomes brighter repeatedly.
42	Hi-Fi 1 Dir 2	The sound gradually becomes brighter, then it rolls continuously.
43	Hi-Fi 2 Dir 2	The sound is slightly unusual and gradually becomes brighter, then it rolls continuously.
44	Hi-Fi 3 Dir 2	The sound is unusual and gradually becomes brighter , then it rolls continuously.
45	Phrase 1 Dir	Repetitions of a roll phrase.
46	Phrase 2 Dir	Repetitions of a roll phrase.
47	Phrase 3 Dir	Repetitions of a roll phrase.
48	Phrase 4 Dir	Repetitions of a roll phrase.
49	Phrase 5 Dir	Repetitions of a roll phrase.
50	Phrase 6 Dir	Repetitions of a roll phrase.
51	Phrase 7 Dir	Repetitions of a roll phrase.
52	Phrase 8 Dir	Repetitions of a roll phrase.
53	Phrase 9 Dir	Repetitions of a roll phrase.
54	Phrase 10 Dir	Repetitions of a roll phrase.
55	Phrase 11 Dir	Repetitions of a roll phrase.
56	Phrase 12 Dir	Repetitions of a roll phrase.
57	Fill 1	Plays fill-in.
58	Fill 2	Plays fill-in.
59	Fill 3	Plays fill-in.
60	Fill 4	Plays fill-in.
61	Fill 5	Plays fill-in.
62	Fill 6	Plays fill-in.
63	Fill 7	Plays fill-in.
64	Fill 8	Plays fill-in.
65	Flam 1	Plays flam.
66	Flam 2	Plays flam.
67	Flam 3	Plays flam.

Groove Template List

When using Groove Quantize, please be aware of the following points to achieve the maximum effect.

- These templates are for 4/4 time. Using them for other time signatures may not produce the desired effect.
- The musical genres listed for each template are only guidelines. Try them with other types of music as well.
- If there are inaccuracies in timing, the desired effect may not be obtained. In this case, apply Grid Quantize to correct the inaccuracies before applying Groove Quantize.
- These templates were created with a tempo of 120–140 in mind.

No.	Template	Effect
1	8Beat Hi-Accent	pops with hard accenting
2	8Beat Lo-Swing	pops with light swing
3	8Beat Hi-Swing	pops with hard swing
4	8Beat Rhumba 1	rhumba with hard accenting
5	8Beat Rhumba 2	rhumba with light swing
6	8Beat Rhumba 3	rhumba with hard swing
7	16Beat Hi-Accent	dance with hard accenting
8	16Beat Lo-Swing	dance with light swing
9	16Beat Hi-Swing	dance with hard swing
10	16Beat Fusion 1	fusion with hard accenting
11	16Beat Fusion 2	fusion with light swing
12	16Beat Fusion 3	fusion with hard swing
13	16Beat Reggae 1	reggae with hard accenting
14	16Beat Reggae 2	reggae with light swing
15	16Beat Reggae 3	reggae with hard swing
16	Samba	samba
17	Salsa	salsa
18	Triplets	triplets
19	Lagging Triplets	lagging triplets
20	Sextuplets	sextuplets

1. TRANSMITTED DATA

■ Channel Voice Message

● Note Off

Status 2nd byte 3rd byte
9nH kkH 00H

n=MIDI channel : 0H-FH (ch.1-ch.16)
kk=Note number : 00H-7FH (0-127)

● Note on

Status 2nd byte 3rd byte
9nH kkH vvH

n=MIDI channel : 0H-FH (ch.1-ch.16)
kk=Note number : 00H-7FH (0-127)
vv=Velocity : 01H-7FH (1-127)

Pad	Note Number	Pad	Note Number
KICK 1	36 (24H)	ROLL KICK 1	100 (64H)
KICK 2	35 (23H)	ROLL KICK 2	101 (65H)
SNARE 1	38 (26H)	ROLL SNARE 1	102 (66H)
SNARE 2	40 (28H)	ROLL SNARE 2	103 (67H)
CLOSED HH	42 (2AH)	ROLL CLOSED HH	104 (68H)
OPEN HH	46 (2EH)	ROLL OPEN HH	105 (69H)
HIT 1	50 (32H)	ROLL HIT 1	106 (6AH)
RIDE	51 (33H)	ROLL RIDE	107 (6BH)
HIT 2	47 (2FH)	ROLL HIT 2	108 (6CH)
CRASH	49 (31H)	ROLL CRASH	109 (6DH)
HIT 3	43 (2BH)	ROLL HIT 3	110 (6EH)
PERC 1	60 (3CH)	ROLL PERC 1	111 (6FH)
PERC 2	61 (3DH)	ROLL PERC 2	112 (70H)

● Control Change

○ Bank Select

This message is transmitted when the "MIDI Program change switch" of the MIDI mode is set at ON.

Status 2nd byte 3rd byte
BnH 00H mmH
BnH 20H llH

n=MIDI channel : 0H-FH(ch.1-ch.16)
mm=Bank number (MSB) : 00H-7FH (0-127)
ll=Bank number (LSB) : 00H-7FH (0-127)

- * Channel number is transmitted over the channel set in the Drum part.
- * The Drum kit corresponding to each Bank Select are as follows.
- * Bank number (LSB) is always transmitted in 00H.

Bank Select	Program No	Drum Kit
MSB	LSB	
81	00	0 - 127
85	00	0 - 63
		Preset 0-127
		User 0-63

○ Volume

This message is transmitted when the "MIDI Volume switch" of the MIDI mode is set at ON.

Status 2nd byte 3rd byte
BnH 07H vvH

n=MIDI channel : 0H-FH (ch.1-ch.16)
vv=Volume : 00H-7FH (0-127)

- * Transmitted when the "MIDI Volume" is changed in the MIDI mode.

○ Portamento

This message is transmitted when the "MIDI Control change switch" of the MIDI mode is set at ON.

Status 2nd byte 3rd byte
BnH 41H vvH

n=MIDI channel : 0H-FH (ch.1-ch.16)
vv=Control value : 00H-7FH (0-127)
0-63=OFF 64-127=ON

○ Portamento time

This message is transmitted when the "MIDI Control change switch" of the MIDI mode is set at ON.

Status 2nd byte 3rd byte
BnH 05H vvH

n=MIDI channel : 0H-FH (ch.1-ch.16)
vv=Portamento time : 00H-7FH (0-127)

○ Effect1 (Reverb Level / Delay Feedback)

This message is transmitted when the "MIDI Control change switch" of the MIDI mode is set at ON.

Status 2nd byte 3rd byte
BnH 5BH vvH

n=MIDI channel : 0H-FH (ch.1-ch.16)
vv=Control value : 00H-7FH (0-127)

- * Channel number is transmitted over the channel set in the Drum part.

○ Effect3 (Flanger Level)

This message is transmitted when the "MIDI Control change switch" of the MIDI mode is set at ON.

Status 2nd byte 3rd byte
BnH 5DH vvH

n=MIDI channel : 0H-FH (ch.1-ch.16)
vv=Control value : 00H-7FH (0-127)

- * Channel number is transmitted over the channel set in the Drum part.

○ Data Entry

This message is transmitted when the "MIDI Control change switch" of the MIDI mode is set at ON.

Status 2nd byte 3rd byte
BnH 06H mmH

n=MIDI channel : 0H-FH(ch.1-ch.16)
mm=MSB value of the parameter specified by NRPN

○ Roll Type

This message is transmitted when the "MIDI Control change switch" of the MIDI mode is set at ON.

Status 2nd byte 3rd byte
BnH 12H ppH

n=MIDI channel : 0H-FH (ch.1-ch.16)
pp=Roll type number : 00H-38H (0-67)

- * Transmitted on the MIDI channel set in the Drum part.
- * Transmitted in one of the following operations:
When the Pattern is selected.
When the "Type" is changed in the Roll mode.

○ Roll Speed

This message is transmitted when the "MIDI Control change switch" of the MIDI mode is set at ON.

Status 2nd byte 3rd byte
BnH 13H vvH

n=MIDI channel : 0H-FH (ch.1-ch.16)
vv=Roll speed : 00H-7FH (0-127)

- * Transmitted on the MIDI channel set in the Drum part
- * Transmitted in one of the following operations:
When the Pattern is selected.
When the "Speed" is changed in the Roll mode.

○ NRPN MSB/LSB

This message is transmitted when the "MIDI Control change switch" of the MIDI mode is set at ON.

Status 2nd byte 3rd byte
BnH 63H mmH
BnH 62H llH

n=MIDI channel : 0H-FH (ch.1-ch.16)
mm=MSB of parameter specified by NRPN
ll=LSB of parameter specified by NRPN

NRPN

Control change has an extension field called NRPN (non registered parameter number) in which device-specific function can be defined.
The NRPN can be set without restriction on manufacturer or model. This means that the same parameter number can be assigned different functions by some manufacturers. Therefore, the device which receives this message may not operate as expected.

Tone Modify		Data Entry	
NRPN		MSB	LSB
01H	20H	mmH	TVF Cutoff Frequency mm: 0EH-40H-72H (-50 - 0 - +50)
01H	21H	mmH	TVF Resonance mm: 0EH-40H-72H (-50 - 0 - +50)
01H	64H	mmH	TVF & TVA Envelope Decay Time mm: 0EH-40H-72H (-50 - 0 - +50)
15H	rrH	mmH	Drum Instrument TVF Cutoff Frequency rr: Note number of Drum Instrument mm: 0EH-40H-72H (-50 - 0 - +50)
16H	rrH	mmH	Drum Instrument TVF Resonance rr: Note number of Drum Instrument mm: 0EH-40H-72H (-50 - 0 - +50)
17H	rrH	mmH	Drum Instrument TVF & TVA Envelope Decay Time rr: Note number of Drum Instrument mm: 0EH-40H-72H (-50 - 0 - +50)

● Program Change

This message is transmitted when the "MIDI Program change switch" of the MIDI mode is set at ON.

Status	2nd byte
CnH	ppH

n=MIDI channel : 0H-FH (ch.1-ch.16)
pp=Program number : 00H-7FH (prog.0-prog.127)

* The Program change will be transmitted on the Drum part MIDI channel if the Drum kit is changed.

■ System Exclusive Message

Status	Data byte	Status
F0H	iiH, ddH, ..., eeH	F7H

F0H : System Exclusive
ii=ID Number : 41=Roland
7E=Universal Non-Realtime Message
7F=Universal Realtime Message
dd, ..., ee=Data : 00H-7FH (0-127)
F7H : EOx (End Of Exclusive)

* With the DR-202, the System Exclusive Messages can be used to transmit Bulk Dump of Kit data, Song/Pattern data and MIDI/Utility data. For details refer to "4. Exclusive Communications," on page 85.

■ System Common Message

If the "Sync" of the MIDI mode is set at "MIDI", this message is never transmitted.

● Song Position Pointer

Status	2nd byte	3rd byte
F2H	llH	mmH

mm, ll=Value : 00H, 00H-7F, 7FH (0-16383)

* Transmitted when the "Step" is changed in the Song mode.

● Song Select

Status	2nd byte
F3H	ssH

ss=Song number : 00H-12H (0-18)

* Transmitted in one of the following operations:
When the Song mode has been selected.
When the song has been selected in the Song mode.

■ System Realtime Message

If the "Sync" of the MIDI mode is set at "MIDI", this message is never transmitted. The Timing clock is transmitted even if no songs are played.

● Timing Clock

Status
F8H

* If the "Sync" of the MIDI mode is set at "MIDI", this message is never transmitted.

● Start

Status
FAH

● Continue

Status
FBH

● Stop

Status
FCH

● Active Sensing

Status
FEH

* Transmitted for checking MIDI connections between the DR-202 and external device.

2. RECOGNIZED DATA

■ Channel Voice Message

● Note Off

Status	2nd byte	3rd byte
8nH	kkH	vvH
9nH	kkH	00H

n=MIDI channel : 0H-FH (ch.1-ch.16)
kk=Note number : 00H-7FH (0-127)
vv=Velocity : 00H-7FH (0-127)

The Velocity is always ignored.
This message received on the channel of Drum Part is Ignored.

● Note on

Status	2nd byte	3rd byte
9nH	kkH	vvH

n=MIDI channel : 0H-FH (ch.1-ch.16)
kk=Note number : 00H-7FH (0-127)
vv=Velocity : 01H-7FH (1-127)

Pad	Note Number	Pad	Note Number
KICK 1	36 (24H)	ROLL KICK 1	100 (64H)
KICK 2	35 (23H)	ROLL KICK 2	101 (65H)
SNARE 1	38 (26H)	ROLL SNARE 1	102 (66H)
SNARE 2	40 (28H)	ROLL SNARE 2	103 (67H)
CLOSED HH	42 (2AH)	ROLL CLOSED HH	104 (68H)
OPEN H	46 (2EH)	ROLL OPEN H	105 (69H)
HIT 1	50 (32H)	ROLL HIT 1	106 (6AH)
RIDE	51 (33H)	ROLL RIDE	107 (6BH)
HIT 2	47 (2FH)	ROLL HIT 2	108 (6CH)
CRASH	49 (31H)	ROLL CRASH	109 (6DH)
HIT 3	43 (2BH)	ROLL HIT 3	110 (6EH)
PERC 1	60 (3CH)	ROLL PERC 1	111 (6FH)
PERC 2	61 (3DH)	ROLL PERC 2	112 (70H)

MIDI Implementation

● Control Change

○ Bank Select

This message is received when the "MIDI Program change switch" of the MIDI mode is set at ON.

Status	2nd byte	3rd byte
BnH	00H	mmH
BnH	20H	llH

n=MIDI channel : 0H-FH (ch.1-ch.16)
 mm=Bank number (MSB) : 00H-7FH (0-127)
 ll=Bank number (LSB) : 00H-7FH (0-127)

- Channel number can be received on the channel set in the Drum part.
- The Drum kit set corresponding to each Bank Select are as follows.
- Will not be affected by the received Bank number (LSB).

Bank Select	Program No	Drum Kit
MSB	LSB	
81	00	0 - 127
85	00	0 - 63
		Preset 0-127
		User 0-63

○ Modulation

This message is received when the "MIDI Control change switch" of the MIDI mode is set at ON.

Status	2nd byte	3rd byte
BnH	01H	vvH

n=MIDI channel : 0H-FH (ch.1-ch.16)
 vv=Modulation depth : 00H-7FH (0-127)

○ Expression

This message is received when the "MIDI Expression switch" of the MIDI mode is set at ON.

Status	2nd byte	3rd byte
BnH	0BH	vvH

n=MIDI channel : 0H-FH (ch.1-ch.16)
 vv=Expression : 00H-7FH (0-127)

○ Portamento

This message is received when the "MIDI Control change switch" of the MIDI mode is set at ON.

Status	2nd byte	3rd byte
BnH	41H	vvH

n=MIDI channel : 0H-FH (ch.1-ch.16)
 vv=Control value : 00H-7FH (0-127)
 0-63=OFF 64-127=ON

- Upon receipt of a Note On while the Portamento is on, continuous pitch change starts with the previously sounded Note number or previously specified Source note number.
- The speed of the pitch change caused by Portamento is determined by the Portamento Time parameter.

○ Portamento Control

This message is received when the "MIDI Control change switch" of the MIDI mode is set at ON.

Status	2nd byte	3rd byte
BnH	54H	kkH

n=MIDI channel : 0H-FH (ch.1-ch.16)
 kk=Source note number : 00H-7FH (0-127)

- A Note On message received immediately after a Portamento control will be sounded with the pitch changing smoothly from the source note number.
- The speed of the pitch change caused by Portamento is determined by the Portamento Time parameter.

○ Portamento Time

This message is received when the "MIDI Control change switch" of the MIDI mode is set at ON.

Status	2nd byte	3rd byte
BnH	05H	vvH

n=MIDI channel : 0H-FH (ch.1-ch.16)
 vv=Portamento time : 00H-7FH (0-127)

- Adjusts the speed of the pitch change when Portamento is on or when Portamento control is used. "0" represents the highest rate.

○ Effect1 (Reverb Level / Delay Feedback)

This message is received when the "MIDI Control change switch" of the MIDI mode is set at ON.

Status	2nd byte	3rd byte
BnH	5BH	vvH

n=MIDI channel : 0H-FH (ch.1-ch.16)
 vv=Control value : 00H-7FH (0-127)

- Channel number can be received on the channel set in the Drum part.
- This message determines the level of Reverb when the selected Effect is Reverb, or the Feedback when the selected effect is Delay.
- Reverb/Delay effect is not obtained if the Reverb/Delay send level of each instrument in the Drum kit is not set at high.

○ Effect3 (Flanger Level)

This message is received when the "MIDI Control change switch" of the MIDI mode is set at ON.

Status	2nd byte	3rd byte
BnH	5DH	vvH

n=MIDI channel : 0H-FH (ch.1-ch.16)
 vv=Control value : 00H-7FH (0-127)

- Channel number can be received on the channel set in the Drum part.
- Flanger effect is not obtained if the Flanger send level of each instrument in the Drum kit is not set at high.

○ Data Entry

This message is received when the "MIDI Control change switch" of the MIDI mode is set at ON.

Status	2nd byte	3rd byte
BnH	06H	mmH
BnH	26H	llH

n=MIDI channel : 0H-FH (ch.1-ch.16)
 mm=MSB value of the parameter specified by RPN/NRPN
 ll=LSB value of the parameter specified by RPN/NRPN

○ Volume

This message is received when the "MIDI Volume switch" of the MIDI mode is set at ON.

Status	2nd byte	3rd byte
BnH	07H	vvH

n=MIDI channel : 0H-FH (ch.1-ch.16)
 vv=Volume : 00H-7FH (0-127)

- The volume of the Track corresponding to the MIDI channel through which the message is received can be adjusted.
 Real volume is determined by (Volume value) x (Expression value).

○ Panpot

This message is received when the "MIDI Control change switch" of the MIDI mode is set at ON.

Status	2nd byte	3rd byte
BnH	0AH	vvH

n=MIDI channel : 0H-FH (ch.1-ch.16)
 vv=Panpot : 00H-40H-7FH (0, 1-64-127)

- 0, 1 means Left, 64 means Center 127 means Right. 127 steps in total can be set.
 Panpot of the instrument corresponds to the received MIDI channel is changed relatively as the received value.

○ Hold1

This message is received when the "MIDI Control change switch" of the MIDI mode is set at ON.

Status	2nd byte	3rd byte
BnH	40H	vvH

n=MIDI channel : 0H-FH (ch.1-ch.16)
 vv=Control value : 00H-7FH (0-127)
 0-63=OFF 64-127=ON

○ Roll Type

This message is received when the "MIDI Control change switch" of the MIDI mode is set at ON.

Status	2nd byte	3rd byte
BnH	12H	ppH

n=MIDI channel : 0H-FH (ch.1-ch.16)
 pp=Roll type number : 00H-38H (0-67)

- * Received on the MIDI channel set in the Drum part.
- * Roll type number 68 or higher is ignored.

○ Roll Speed

This message is received when the "MIDI Control change switch" of the MIDI mode is set at ON.

Status	2nd byte	3rd byte
BnH	13H	vvH

n=MIDI channel : 0H-FH (ch.1-ch.16)
 vv=Roll speed : 00H-7FH (0-127)

- * Received on the MIDI channel set in the Drum part.

○ RPN MSB/LSB

This message is received when the "MIDI Control change switch" of the MIDI mode is set at ON.

Status	2nd byte	3rd byte
BnH	65H	mmH
BnH	64H	llH

n=MIDI channel : 0H-FH (ch.1-ch.16)
 mm=MSB of parameter specified by RPN
 ll=LSB of parameter specified by RPN

RPN

Control Changes include RPN (Registered Parameter Numbers), which are extended parameters whose function is defined in the MIDI specification. RPN can be used to change instrument parameters. When using RPNs, first the RPN (Controller numbers 100 and 101; they can be sent in any order) is transmitted to specify the parameter you wish to control. Then, Data Entry messages (Controller numbers 6 and 38) are used to set the value of the specified parameter. Once a RPN parameter has been specified, all further Data Entry messages on that channel are considered to apply to that specified parameter. In order to prevent accidents, when the desired setting has been made for the parameter, it is recommended that RPN be set to Null.

RPN	MSB	LSB	Data Entry
00H	00H	mmH	Pitch Bend Sensitivity mm: 00H-18H (0-24 semitones) Up to 2 octaves, default settings 1octave. This setting becomes effective for subsequent Pitch Bend messages.
00H	01H	mmHllH	Master Fine Tuning mm, ll: 00H, 00H-0FH, 00H-7FH, 7FH (-8192 x 100/8192 - 0 - +8192 x 100/8192 cent)
7FH	7FH	--	RPN reset No specified parameter is assigned to RPN and NRPN. Current value is not affected.

○ NRPN MSB/LSB

This message is received when the "MIDI Control change switch" of the MIDI mode is set at ON.

Status	2nd byte	3rd byte
BnH	63H	mmH
BnH	62H	llH

n=MIDI channel : 0H-FH (ch.1-ch.16)
 mm=MSB of parameter specified by NRPN
 ll=LSB of parameter specified by NRPN

NRPN

Control change has an extension field called NRPN (non registered parameter number) in which device-specific function can be defined. The NRPN can be set without restriction on manufacturer or model. This means that the same parameter number can be assigned different functions by some manufacturers. Therefore, the device which receives this message may not operate as expected. With NRPN or RPN, messages should be processed in the correct order. However, conventional sequencer cannot assure the correct order of MIDI messages occurring at almost the same time. When using NRPNs, first the NRPN (Controller numbers 98 and 99; they can be sent in any order) is transmitted to specify the parameter you wish to control. Then, Data Entry messages (Controller numbers 6 and 38) are used to set the value of the specified parameter. Once a NRPN parameter has been specified, all further Data Entry messages on that channel are considered to apply to that specified parameter. In order to prevent accidents, when the desired setting has been made for the parameter, it is recommended that RPN be set to Null (RPN number=7FH/7FH).

Tone Modify		Data Entry	
NRPN	MSB	LSB	
01H	20H	mmH	TVF Cutoff Frequency mm: 0EH-40H-72H (-50 - 0 - +50)
01H	21H	mmH	TVF Resonance mm: 0EH-40H-72H (-50 - 0 - +50)
01H	64H	mmH	TVF & TVA Envelope Decay Time mm: 0EH-40H-72H (-50 - 0 - +50)
15H	rrH	mmH	Drum Instrument TVF Cutoff Frequency rr: Note number of Drum Instrument mm: 0EH-40H-72H (-50 - 0 - +50)
16H	rrH	mmH	Drum Instrument TVF Resonance rr: Note number of Drum Instrument mm: 0EH-40H-72H (-50 - 0 - +50)
17H	rrH	mmH	Drum Instrument TVF & TVA Envelope Decay Time rr: Note number of Drum Instrument mm: 0EH-40H-72H (-50 - 0 - +50)

- * LSB in Data entry is ignored.

● Program Change

This message is received when the "MIDI Program change switch" of the MIDI mode is set at ON.

Status	2nd byte
CnH	ppH

n=MIDI channel : 0H-FH (ch.1-ch.16)
 pp=Program number : 00H-7FH (prog.1-prog.128)

- * Program change selects a Drum kit.
 The first Note On after receiving a Program change sounds a voice with a new tone with exception of the voices which have been sounded before the Program change is received.

● Pitch Bend Change

Status	2nd byte	3rd byte
EnH	llH	mmH

n=MIDI channel : 0H-FH (ch.1-ch.16)
 mm, ll=Pitch bend value : 00H, 00H-40H, 40H-7FH, 7FH
 (-8192 - 0 - +8191)

MIDI Implementation

■ Channel Mode Message

● All Sound Off

Status	2nd byte	3rd byte
BnH	78H	00H

n=MIDI channel : 0H-FH (ch.1-ch.16)

- All current active voice in the specified channel will be shut off.

● Reset All Controllers

Status	2nd byte	3rd byte
BnH	79H	00H

n=MIDI channel : 0H-FH (ch.1-ch.16)

- The following control values on the specified channel return to the default value.

Controller	Default Value
Pitch Bend Change	±0
Hold1	0 (off)
Modulation	0 (min)
Expression	127 (max)
RPN/NRPN	No specified parameter / No change in value

● All Note Off

Status	2nd byte	3rd byte
BnH	7BH	00H

n=MIDI channel : 0H-FH (ch.1-ch.16)

- All active voices on the specified channel are turned off. (Each voice responds as to a "Note Off.") If Hold1 is ON, this message does not become effective until Hold is OFF. Drum track ignores this message.

● OMNI OFF

Status	2nd byte	3rd byte
BnH	7CH	00H

n=MIDI channel : 0H-FH (ch.1-ch.16)

- OMNI OFF is only recognized as "All Notes Off."

● MONO

Status	2nd byte	3rd byte
BnH	7EH	mmH

n=MIDI channel : 0H-FH (ch.1-ch.16)

mm=Number of mono : 00H-10H (0-16)

- MONO is only recognized as "All Notes Off."
- Current mode does not change.

● POLY

Status	2nd byte	3rd byte
BnH	7FH	00H

n=MIDI channel : 0H-FH (ch.1-ch.16)

- POLY is only recognized as "All Notes Off."
- Current mode does not change.

■ System Exclusive Message

Status	Data byte	Status
F0H	iiH, ddH, ..., eeH	F7H

F0H : System Exclusive
ii=ID number : 41=Roland
7E=Universal Non-Realtime Message
7F=Universal Realtime Message
dd, ..., ee=Data : 00H-7FH (0-127)
F7H : EOX (End Of Exclusive)

- With the DR-202, the System Exclusive Messages can be used to transmit Bulk Dump of Kit data, Song/Pattern data and MIDI/Utility data. For details refer to "4. Exclusive Communications," on page 85.

■ System Common Message

Recognized only when the DR-202 is in stop and "Sync" of the MIDI mode is set at MIDI.

● Song Position Pointer

Status	2nd byte	3rd byte
F2H	llH	mmH

mm, ll=Value : 00H, 00H-7F, 7FH (0-16383)

- If the DR-202 receive Song Position Pointer in Song mode, it calls the position in the song.

● Song select

Status	2nd byte	byte
F3H	ssH	

ss=Song number : 00H-12H (0-18)

- When received in Song mode, it changes the songs.

■ System Realtime Message

● Timing Clock

Status
F8H

- This message is ignored when the "Sync mode" of the MIDI mode is set at INT or REMOTE.

● Start

Status
FAH

- This message is ignored when the "Sync mode" of the MIDI mode is set at INT.

● Continue

Status
FBH

- This message is ignored when the "Sync mode" of the MIDI mode is set at INT.

● Stop

Status
FBH

- This message is ignored when the "Sync mode" of the MIDI mode is set at INT.

● Active Sensing

Status
FEH

- Whenever the DR-202 receives this message, it monitors the interval of the incoming data. If the subsequent message has not arrived within about 420 ms after the previous data, it processes all tracks as though it has received All Sound Off, All Notes Off, Reset All Controllers, and mutes the sounding voices, then stops monitoring receiving interval.

3. Messages stored during Realtime recording of patterns

■ Channel Voice Message

● Note Off

Status	2nd byte	3rd byte
9nH	kkH	00H

n=MIDI channel : 0H-FH (ch.1-ch.16)
kk=Note number : 00H-7FH (0-127)

● Note on

Status	2nd byte	3rd byte
9nH	kkH	vvH

n=MIDI channel : 0H-FH (ch.1-ch.16)
kk=Note number : 00H-7FH (0-127)
vv=Velocity : 01H-7FH (1-127)

● Control Change

○ Portamento

Recording is disabled if MIDI Control change switch of MIDI mode is set at OFF.

Status	2nd byte	3rd byte
BnH	41H	vvH

n=MIDI channel : 0H-FH (ch.1-ch.16)
vv=Control value : 00H-7FH (0-127)
0-63=OFF 64-127=ON

○ Portamento Time

Recording is disabled if MIDI Control change switch of MIDI mode is set at OFF.

Status	2nd byte	3rd byte
BnH	05H	vvH

n=MIDI channel : 0H-FH (ch.1-ch.16)
vv=Portamento time : 00H-7FH (0-127)

○ Data Entry

Recording is disabled if MIDI Control change switch of MIDI mode is set at OFF.

Status	2nd byte	3rd byte
BnH	06H	mmH

n=MIDI channel : 0H-FH(ch.1-ch.16)
mm=MSB value of the parameter specified by NRPN

NRPN

Tone Modify		Data Entry	
NRPN			
MSB	LSB		
01H	20H	mmH	TVF Cutoff Frequency mm: 0EH-40H-72H (-50 - 0 - +50)
01H	21H	mmH	TVF Resonance mm: 0EH-40H-72H (-50 - 0 - +50)
01H	64H	mmH	TVF & TVA Envelope Decay Time mm: 0EH-40H-72H (-50 - 0 - +50)
15H	rrH	mmH	Drum Instrument TVF Cutoff Frequency rr: Note number of Drum Instrument mm: 0EH-40H-72H (-50 - 0 - +50)
16H	rrH	mmH	Drum Instrument TVF Resonance rr: Note number of Drum Instrument mm: 0EH-40H-72H (-50 - 0 - +50)
17H	rrH	mmH	Drum Instrument TVF & TVA Envelope Decay Time rr: Note number of Drum Instrument mm: 0EH-40H-72H (-50 - 0 - +50)

4. Exclusive Communications

■ General

DR-202 can do one-way communications to send and receive parameters for kits, system setup, sequence, user chord.

Model ID included in the exclusive message should be 00H 13H. The device ID code should be System Exclusive Device ID of MIDI parameter. Note that the actual value that set in device ID field is smaller by one than the value set System Exclusive Device ID of MIDI parameter.

● Universal Non-Realtime System Exclusive Message

○ Inquiry Request

Status	data byte	Status
F0H	7EH, dev, 06H, 01H	F7H

Byte	Description
F0H	Exclusive Status
7EH	ID Number (Universal Non-Realtime Message)
dev	Device ID (dev: 10H(17)-1FH(32))
06H	Sub ID#1 (General Information)
01H	Sub ID#2 (Inquiry Request)
F7H	EOX (End of Exclusive)

- The "dev" is own device number or 7FH (Broadcast).
- When Inquiry Request is received, Inquiry Reply message will be transmitted.

○ Inquiry Reply

Status	Data byte	Status
F0H	7EH, dev, 06H, 02H, 41H, 01H, 13H, 00H, 00H, 00H, 03H, 00H, 00H	F7H

Byte	Description
F0H	Exclusive Status
7EH	ID Number (Universal Non-Realtime Message)
dev	Device ID (dev: 10H(17)-1FH(32))
06H	Sub ID#1 (General Information)
02H	Sub ID#2 (Inquiry Reply)
41H	Manufacturer ID (Roland)
01H, 13H	Device Family Code
00H, 00H	Device Family Number Code
00H, 03H, 00H, 00H	Software Revision Level
F7H	EOX (End of Exclusive)

- Reply the message by the unique device ID (dev) when the device has received the "Inquiry Request Message" in the Broadcast.

MIDI Implementation

● Data Transmission

○ Request data RQ1 11H

Byte	Description
F0H	Exclusive status
41H	manufacturer ID (Roland)
DEV	device ID (00H-0FH)
00H	model ID (DR-202) MSB
13H	model ID (DR-202) LSB
11H	command ID (RQ1)
aaH	address MSB
aaH	address
aaH	address
aaH	address LSB
ssH	size MSB
ssH	size
ssH	size
ssH	size LSB
sum	checksum
F7H	EOX (End of Exclusive)

○ Data set DT1 12H

Byte	Description
F0H	Exclusive status
41H	manufacturer ID (Roland)
DEV	device ID (00H-0FH)
00H	model ID (DR-202) MSB
13H	model ID (DR-202) LSB
12H	command ID (DT1)
aaH	address MSB
aaH	address
aaH	address
aaH	address LSB
ddH	address MSB
:	
ddH	data LSB
sum	checksum
F7H	EOX (End of Exclusive)

■ Transmission

The DR-202 transmits Exclusive message only when MIDI Bulk dump is performed by panel operation in the menu of MIDI mode.

■ Receive

The DR-202 receives Exclusive message only when MIDI Bulk dump is not performed and it is in stop.

5. Parameter Address Map

Address are shown in every 7-bit hexadecimal.

Address	MSB			LSB
Binary 7 bit hex.	0aaa aaaa AA	0bbb bbbb BB	0ccc cccc CC	0ddd dddd DD

■ Parameter bass address

Start Address	Description
00 00 00 00	kit parameters
40 00 00 00	system setup parameters
50 00 00 00	sequence data

1. Kit parameters

Data included in this area is all kit data.
If you want to send Data Request to the DR-202 in this area, set the address and the size as follows.

Address : 00 00 00 00
size : 30 00 00 00

The DR-202 ignores the Data request which designate different address or size.
No data in this area can be transferred in unit of one byte.

2. System setup parameters

Data included in this area is all MIDI/utility data.
If you want to send Data Request to the DR-202 in this area, set the address and the size as follows.

Address : 40 00 00 00
size : 10 00 00 00

The DR-202 ignores the Data request which designate different address or size.
No data in this area can be transferred in unit of one byte.

3. Sequence data

Data included in this area are all user songs and all user patterns.
If you want to send Data Request to the DR-202 in this area, set the address and the size as follows.

Address : 50 00 00 00
size : 20 00 00 00

The DR-202 ignores the Data request which designate different address or size.
No data in this area can be transferred in unit of one byte.

6. Supplementary material

● Decimal/Hexadecimal table (hexadecimal values are indicated by a following "H")

MIDI uses 7-bit hexadecimal values to indicate data values and the address and size of exclusive messages. The following table shows the correspondence between decimal and hexadecimal numbers.

D	H	D	H	D	H	D	H
0	00H	32	20H	64	40H	96	60H
1	01H	33	21H	65	41H	97	61H
2	02H	34	22H	66	42H	98	62H
3	03H	35	23H	67	43H	99	63H
4	04H	36	24H	68	44H	100	64H
5	05H	37	25H	69	45H	101	65H
6	06H	38	26H	70	46H	102	66H
7	07H	39	27H	71	47H	103	67H
8	08H	40	28H	72	48H	104	68H
9	09H	41	29H	73	49H	105	69H
10	0AH	42	2AH	74	4AH	106	6AH
11	0BH	43	2BH	75	4BH	107	6BH
12	0CH	44	2CH	76	4CH	108	6CH
13	0DH	45	2DH	77	4DH	109	6DH
14	0EH	46	2EH	78	4EH	110	6EH
15	0FH	47	2FH	79	4FH	111	6FH
16	10H	48	30H	80	50H	112	70H
17	11H	49	31H	81	51H	113	71H
18	12H	50	32H	82	52H	114	72H
19	13H	51	33H	83	53H	115	73H
20	14H	52	34H	84	54H	116	74H
21	15H	53	35H	85	55H	117	75H
22	16H	54	36H	86	56H	118	76H
23	17H	55	37H	87	57H	119	77H
24	18H	56	38H	88	58H	120	78H
25	19H	57	39H	89	59H	121	79H
26	1AH	58	3AH	90	5AH	122	7AH
27	1BH	59	3BH	91	5BH	123	7BH
28	1CH	60	3CH	92	5CH	124	7CH
29	1DH	61	3DH	93	5DH	125	7DH
30	1EH	62	3EH	94	5EH	126	7EH
31	1FH	63	3FH	95	5FH	127	7FH

D: decimal
H: hexadecimal

- Decimal expressions such as used for MIDI channel, Bank Select, and Program Change will be the value 1 greater than the decimal value given in the above table.
- Since each MIDI byte carries 7 significant data bits, each byte can express a maximum of 128 different values. Data for which higher resolution is required must be transmitted using two or more bytes. For example a value indicated as a two-byte value of aa bbH would have a value of $aa \times 128 + bb$.
- For a signed number (+/-), 00H = -64, 40H = +/-0, and 7FH = +63. I.e., the decimal equivalent will be 64 less than the decimal value given in the above table. For a two-byte signed number, 00 00H = -8192, 40 00H = +/-0, and 7F 7FH = +8191. For example the decimal expression of aa bbH would be $aa \times 128 + bb - 64 \times 128$.
- Hexadecimal notation in two 4-bit units is used for data indicated as 'nibbled'. The nibbled two-byte value of 0a 0b H would be $a \times 16 + b$.

<Example 1> What is the decimal equivalent of 5AH?

From the above table, 5AH = 90.

<Example 2> What is the decimal equivalent of the 7-bit hexadecimal values 12 34H?

From the above table, 12H = 18 and 34H = 52
Thus, $18 \times 128 + 52 = 2356$

<Example 3> What is the decimal equivalent of the nibbled expression 0A 03 09 0DH?

From the above table, 0AH = 10, 03H = 3, 09H = 9, 0DH = 13
Thus, the result is $(10 \times 16 + 3) \times 16 + 9 \times 16 + 13 = 41885$

<Example 4> What is the nibbled equivalent of the decimal number 1258?

```

16 | 1258
   | 78 ... 10
   | 4 ... 14
   | 0 ... 4

```

From the above table, 0=00H, 4=04H, 14=0EH, 10=0AH
Thus the result is 00 04 0E 0AH

○ Examples of actual MIDI messages

<Example 2> CE 49

CnH is the Program Change status and 'n' is the MIDI channel number. Since 9H = 9, and 49H = 73, this is a Program Change message of MIDI CH = 10, Program number 74 (in the GS sound map, Flute).

○ Examples of exclusive messages and calculating the checksum

Roland exclusive messages (RQ1, DT1) are transmitted with a checksum at the end of the data (before F7) to check that the data was received correctly. The value of the checksum is determined by the address and data (or size) of the exclusive message.

◆ How to calculate the checksum (hexadecimal values are indicated by a 'H')

The checksum consists of a value whose lower 7 bits are 0 when the address, size and checksum itself are added.

The following formula shows how to calculate the checksum when the exclusive message to be transmitted has an address of aa bb cc ddH, and data or size of ee ffH.

$$aa + bb + cc + dd + ee + ff = \text{total}$$

$$\text{total} / 128 = \text{quotient} \dots \text{remainder}$$

$$128 - \text{remainder} = \text{checksum}$$

Checksum is 0 if the remainder is 0.

<Example> Request to transfer the kit parameter

See the "Parameter Address Map"

address : 00 00 00 00H
size : 30 00 00 00H

F0 41 11 00 13 11 00 00 00 30 00 00 ?? F7
(1) (2) (3) (4) (5) address size checksum (6)

- (1) Exclusive status
- (2) ID number (Roland)
- (3) device ID(17)
- (4) model ID (DR-202)
- (5) command ID (RQ1)
- (6) End of Exclusive

Next we calculate the checksum.

$$00H + 00H + 00H + 00H + 30H + 00H + 00H + 00H = 0 + 0 + 0 + 0 + 48 + 0 + 0 + 0 = 48 (\text{sum})$$

$$48 (\text{total}) + 128 (\text{quotient}) = 0 (\text{quotient}) \dots 48 (\text{remainder})$$

$$\text{checksum} = 128 - 48 (\text{quotient}) = 80 = 50H$$

This means that the message transmitted will be F0 41 11 00 13 11 00 00 00 30 00 00 50 F7.

● ASCII code table

On the DR-202, the following ASCII code set is used for processing data such as the Pattern Name, Song Name, etc.

Char	Hex.	Char	Hex.	Char	Hex.	Char	Hex.
SP	20H	a	61H	0	30H	:	3AH
A	41H	b	62H	1	31H	;	3BH
B	42H	c	63H	2	32H	<	3CH
C	43H	d	64H	3	33H	>	3DH
D	44H	e	65H	4	34H	=	3EH
E	45H	f	66H	5	35H	?	3FH
F	46H	g	67H	6	36H	@	40H
G	47H	h	68H	7	37H		5BH
H	48H	i	69H	8	38H	\	5CH
I	49H	j	6AH	9	39H]	5DH
J	4AH	k	6BH	1	21H	^	5EH
K	4BH	l	6CH	"	22H	~	5FH
L	4CH	m	6DH	#	23H	^	60H
M	4DH	n	6EH	\$	24H	{	6BH
N	4EH	o	6FH	%	25H		7CH
O	4FH	p	70H	&	26H	}	7DH
P	50H	q	71H	'	27H		
Q	51H	r	72H	(28H		
R	52H	s	73H)	29H		
S	53H	t	74H	*	2AH		
T	54H	u	75H	+	2BH		
U	55H	v	76H	,	2CH		
V	56H	w	77H	-	2DH		
W	57H	x	78H	.	2EH		
X	58H	y	79H	/	2FH		
Y	59H	z	7AH				
Z	5AH						

Note: SP indicates "space".

MIDI Implementation Chart

Function...	Transmitted	Recognized	Remarks
Basic Channel Default Changed	1-16 1-16	1-16 1-16	Memorized
Mode Default Messages Altered	Mode 3 X *****	Mode 3 X	
Note Number : True Voice	0-127 *****	0-127 0-127	* 1
Velocity Note ON Note OFF	O 9n, v=1-127 X	O X	
After Touch Key's Ch's	X X	X X	
Pitch Bend	X	O	
Control Change	0, 32 O 1 X 5 O 6, 38 O 7 O 10 X 11 X 18 O 19 O 64 X 65 O 84 X 91 O 93 O 98, 99 O 100, 101 X	O *5 O *2 O *2 O *2 O *3 O *2 O *4 O *2 O *2 O *2 O *2 O *2 O (Reverb) *2 O (Flanger) *2 O *2 O *2	Bank select Modulation Portamento time Data entry Volume Panpot Expression Roll type Roll speed Hold1 Portamento Portamento control Effect1 Effect3 NRPN LSB, MSB RPN LSB, MSB
Prog Change : True #	O 0-127	O *5 0-127	Kit change
System Exclusive	O	O	
System Common : Song Pos : Song Sel : Tune	O *6 O *6 x	O *7 x *7 x	0-18
System Real Time : Clock : Command	X *6 X *6	O *7 O *8	
Aux Message : Local ON/OFF : All Notes OFF : All sound off : Reset all controllers : Active Sense : System Reset	X X X X O O X	X O O O O O X	
Notes	<ul style="list-style-type: none"> * 1 Relationship between Percussion instrument and Note number is common to transmit and receive. * 2 Can be set to O or X through MIDI Control change switch (parameter) and memorized. * 3 Can be set to O or X through MIDI Volume switch (parameter) and memorized. * 4 Can be set to O or X through MIDI Expression switch (parameter) and memorized. * 5 Can be set to O or X through MIDI Program change switch (parameter) and memorized. * 6 Not transmitted when Sync mode (parameter) is MIDI. * 7 Not transmitted when Sync mode (parameter) is INT or REMOTE. * 8 Not transmitted when Sync mode (parameter) is INT. 		

MIDI Implementation

Mode 1 : OMNI ON, POLY
Mode 3 : OMNI OFF, POLY

Mode 2 : OMNI ON, MONO
Mode 4 : OMNI OFF, MONO

O : Yes
X : No

Specifications

DR-202: Dr. Groove

● Maximum Polyphony

24 voices

● Instruments

256 (Drums: 207, Bass: 49)

● Rhythm Patterns

Preset Patterns: 400

User Patterns: 100

● Songs

20 (Includes One Demo Song)

● Resolution

96 Clocks/Quarter Note

● Tempo

40.0–250.0 BPM

● Display

LCD (16 Characters x 2 Lines)

● Data Input

Realtime Recording

Step Recording

Step Edit

● Pads

13

● Controls

Value Dial

Volume

Low

Instrument Select

Realtime Modify: Cutoff, Resonance, Delay

Effects: Reverb/Delay, Flanger

● Synchronization

MIDI

● Connectors

Headphone Jack (stereo miniature phone type)

Line Out Jacks (L, R)

MIDI Connectors (IN, OUT)

Foot Switch Jack

DC IN Jack

● Power Supply

DC 9 V: Dry batteries (LR6 (AA) type) x 6,

AC adaptor (BOSS PSA Series: optional)

● Current Draw

200 mA

Expected battery life under continuous use:

Carbon: Approx. 4 hours

Alkaline: Approx. 8 hours

These figures will vary depending on the actual conditions of use.

● Dimensions

258 (W) x 221 (D) x 85 (H) mm

10-3/16 (W) x 8-3/4 (D) x 3-3/8 (H) inches

● Weight

1.1 kg / 2 lbs 7 oz (including batteries)

● Accessories

Owner's Manual

Dry batteries (LR6 (AA) type) x 6

Roland Service (information sheet)

● Options

AC adaptor (BOSS PSA Series)

Foot Switch (BOSS FS-5U)

* In the interest of product improvement, the specifications and/or appearance of this unit are subject to change without prior notice.

Index

A

AC adaptor9, 10
ACC, A (ACCENT).....15, 29, 33, 39, 42, 69
ALL INST.....16, 29
AVAIL MEMORY (UTILITY).....63, 69
Accent.....15, 29, 33, 39, 42, 69
All Mute Lift Function.....32
All (Factory Reset).....23
Audio cable10

B

B (BEAT)19, 38, 68
BPM.....25, 28, 49, 52
BULK DUMP (MIDI)59
Beat19, 38, 68
Bulk Dump59, 60
Bulk Load60
[BASS]11, 33, 55
[BPM]25, 28, 39

C

CHANNEL BASS (MIDI)58, 69
CHANNEL DRUM (MIDI)58, 69
CHANNEL EXT (MIDI)58, 69
CONTROL CHG SW (MIDI)59, 69
Controller Section.....24
Cord Hook.....9
Cursor Key6
Cutoff6, 16, 29, 55, 68
[COPY/INS].....50, 54, 56

D

DELAY E.LEVEL.....31, 55, 68
Decay.....16, 30, 55, 68
Delay Effect Level.....68
Delay Feedback.....30, 68
Delay Time31, 55, 68
Delete (Pattern).....50
Demo Song12
[DEL]50, 53

E

EFFECTS30, 55
EXPRESSION SW (MIDI).....59
Effect.....30, 55
External MIDI Sound Module.....36

F

FLANGER16, 30
FLANGER E.LEVEL30, 55, 68
FLANGER SEND.....55, 68
FOOT SWITCH jack.....10, 63
Factory Reset.....22
Flanger Effect Level.....30, 68
Flanger Rate31, 55, 68
Flanger Send Level.....68
Flanger Type31, 55, 68
Foot Switch.....10, 63
Foot Switch Assign.....63, 69

G

G (GATE TIME).....38, 43, 46, 69
Gate Time38, 43, 46, 69
Groove Quantize47
Groove Template.....48, 68
[GROOVE].....48

H

Hold.....34

I

INIT BPM.....28, 52, 69
INST.....29, 68
INSTRUMENT SELECT16, 29
Initial BPM (tempo).....28, 52, 69
Instrument24, 32, 68
Instrument Name17, 29

K

Kit24
Kit (Factory Reset).....23
Kit Name.....15, 29, 48, 68
[KIT]15, 25, 29, 40, 48, 55

L

LCD Contrast63, 69
LOW16
Level.....55, 68
Loop Rest40

M

M (MEASURE).....38, 42, 45, 68
MIDI57, 69
MIDI Channel (Bass Part)58, 69
MIDI Channel (Drum Part).....58, 69
MIDI Channel (External Part).....58, 69
MIDI Control change switch69

MIDI Expression switch	69
MIDI Mode	26
MIDI Program change switch	69
MIDI THRU switch	59, 69
MIDI Volume (Bass Part)	59, 69
MIDI Volume (Drum Part).....	58, 69
MIDI Volume (External Part)	58, 69
MIDI Volume switch	69
Metronome	19, 39, 63
Micro Search.....	45
Mode	26
Mute	32, 49
[MIDI].....	60
[MUTE]	23, 25, 32, 49

N

NOTE	37, 68
Note Number	34, 62
Number of Measure	37, 68

O

OCT (OCTAVE).....	29, 33, 35, 36, 55, 68
OUT ASSIGN BASS (MIDI).....	59, 69
OUT ASSIGN DRUM (MIDI).....	59, 69
Octave	29, 33, 35, 36, 55, 68
Octave Shift	35, 36, 68
Output Assign (Bass Part).....	69
Output Assign (Drum Part).....	69

P

PAN.....	55, 68
PORTAMENTO T.	43, 46, 69
POWER switch	11
PROG CHG SW (MIDI).....	58, 69
Pad	11, 24
Panning.....	68
Part	24
Pattern.....	13, 25
Pattern Mode.....	26
Pattern Name	14, 18, 27, 38, 41, 45, 68
Pitch.....	68
Polarity Switch.....	10
Portamento	35, 43, 46
Portamento Time	35, 43, 46
Preset Pattern	14, 26
Preview (Song Recording)	53
[PATTERN]	14, 26, 27, 38, 41, 45

Q

Q (QUANTIZE)	39, 42, 45, 68
Quantize	39, 42, 45, 68

R

RECOMMEND	28, 69
REV/DLY	17, 30
REV/DLY SEND	55, 68
REVERB E.LEVEL	30, 55, 68
REVERB/DELAY TYPE	31, 55, 68
Realtime Modify	16, 29, 40
Realtime Recording (Pattern)	37
Rehearsal (Realtime Recording)	39
Resonance	6, 29, 68
Reverb Effect Level	68
Reverb Time	31, 55, 68
Reverb/Delay Send Level.....	68
Reverb/Delay Type	31, 55, 68
Roll.....	25, 33, 34, 43, 49
Roll Speed.....	33, 49
Roll Type.....	33, 49
[REC]	19, 38, 41, 45, 52
[ROLL]	23, 25, 33, 34

S

SHIFT	46, 69
STEP	20, 28, 42, 45, 52
SYNC MODE (MIDI)	59, 69
SYS EXCLUS (MIDI)	59, 69
Sequencer Section.....	24
Setup Information	25, 48
Solo Function	32
Song	25
Song Mode.....	26
Song Name	12, 52, 69
SongPattern (Factory Reset).....	23
Sound Generator Section.....	24
Standard Tempo (RECOMMEND).....	28, 48, 69
Step Recording (Pattern)	52
Strong Beat INST (UTILITY).....	63, 69
Strong Beat Instrument.....	63, 69
Strong Beat LEVEL (UTILITY)	63, 69
Strong Beat Level.....	63, 69
Style	12, 25, 68
Sync Mode	59, 69
Synchronizing Performance	61
[SHIFT].....	13, 28, 32, 43, 45, 49, 62
[SONG]	12, 20, 27, 52
[START]	12, 14, 19, 20
[STEP -1/+1]	28

Index

[STOP/CONT].....12, 15, 19, 21
[STYLE].....18, 27, 38, 41, 45

T

THRU SW (MIDI).....59, 69
Tap Tempo29, 49
Tempo28, 29, 48, 49
Tick Time.....37
Timing Shift.....46, 69
[T.SHIFT]46
[TAP/ENTER]23, 25, 29

U

UTILITY.....63, 69
User Pattern.....14, 26
Utility Mode.....26, 63
UtilityMIDI (Factory Reset)23
[UTILITY]63

V

VOLUME.....11
VOLUME BASS (MIDI).....58, 69
VOLUME DRUM (MIDI).....58, 69
VOLUME EXT (MIDI).....58, 69
VOLUME SW (MIDI).....58, 69

W

Weak Beat INST (UTILITY)63, 69
Weak Beat Instrument63, 69
Weak Beat LEVEL (UTILITY).....63, 69
Weak Beat Level63, 69

Blank Chart

Kit Name =										
	INST No.	LEVEL	PITCH	PAN	R/D Send	Fing Send	CUTOFF	RESONANCE	DECAY	
BASS			oct							
KICK 1										
KICK 2										
SNARE 1										
SNARE 2										
CLOSED HH										
OPEN HH										
RIDE										
CRASH										
PERC 1										
PERC 2										
HIT 1										
HIT 2										
HIT 3										
EFFECTS	REVERB/DELAY				FLANGER					
	TYPE	TIME	LEVEL	FEEDBACK	TYPE	RATE	LEVEL			

Kit Name =										
	INST No.	LEVEL	PITCH	PAN	R/D Send	Fing Send	CUTOFF	RESONANCE	DECAY	
BASS			oct							
KICK 1										
KICK 2										
SNARE 1										
SNARE 2										
CLOSED HH										
OPEN HH										
RIDE										
CRASH										
PERC 1										
PERC 2										
HIT 1										
HIT 2										
HIT 3										
EFFECTS	REVERB/DELAY				FLANGER					
	TYPE	TIME	LEVEL	FEEDBACK	TYPE	RATE	LEVEL			

Kit Name =										
	INST No.	LEVEL	PITCH	PAN	R/D Send	Fing Send	CUTOFF	RESONANCE	DECAY	
BASS			oct							
KICK 1										
KICK 2										
SNARE 1										
SNARE 2										
CLOSED HH										
OPEN HH										
RIDE										
CRASH										
PERC 1										
PERC 2										
HIT 1										
HIT 2										
HIT 3										
EFFECTS	REVERB/DELAY				FLANGER					
	TYPE	TIME	LEVEL	FEEDBACK	TYPE	RATE	LEVEL			

Kit Name =									
	INST No.	LEVEL	PITCH	PAN	R/D Send	Fing Send	CUTOFF	RESONANCE	DECAY
BASS			oct						
KICK 1									
KICK 2									
SNARE 1									
SNARE 2									
CLOSED HH									
OPEN HH									
RIDE									
CRASH									
PERC 1									
PERC 2									
HIT 1									
HIT 2									
HIT 3									
EFFECTS	REVERB/DELAY				FLANGER				
	TYPE	TIME	LEVEL	FEEDBACK	TYPE	RATE	LEVEL		

Kit Name =									
	INST No.	LEVEL	PITCH	PAN	R/D Send	Fing Send	CUTOFF	RESONANCE	DECAY
BASS			oct						
KICK 1									
KICK 2									
SNARE 1									
SNARE 2									
CLOSED HH									
OPEN HH									
RIDE									
CRASH									
PERC 1									
PERC 2									
HIT 1									
HIT 2									
HIT 3									
EFFECTS	REVERB/DELAY				FLANGER				
	TYPE	TIME	LEVEL	FEEDBACK	TYPE	RATE	LEVEL		

Kit Name =									
	INST No.	LEVEL	PITCH	PAN	R/D Send	Fing Send	CUTOFF	RESONANCE	DECAY
BASS			oct						
KICK 1									
KICK 2									
SNARE 1									
SNARE 2									
CLOSED HH									
OPEN HH									
RIDE									
CRASH									
PERC 1									
PERC 2									
HIT 1									
HIT 2									
HIT 3									
EFFECTS	REVERB/DELAY				FLANGER				
	TYPE	TIME	LEVEL	FEEDBACK	TYPE	RATE	LEVEL		

For EU Countries

Apparatus containing Lithium batteries

ADVARSEL!

Lithiumbatteri - Eksplosjonsfare ved feilagtig håndtering.
Udskiftning må kun ske med batteri af samme fabrikat og type.
Levér det brugte batteri tilbage til leverandøren.

ADVARSEL

Eksplosjonsfare ved feilaktig skifte av batteri.
Benytt samme batteritype eller en tilsvarende type anbefalt av apparatfabrikanten.
Brukte batterier kasseres i henhold til fabrikantens instruksjoner.

CAUTION

Danger of explosion if battery is incorrectly replaced.
Replace only with the same or equivalent type recommended by the manufacturer.
Discard used batteries according to the manufacturer's instructions.

VARNING

Explosionsfara ved feilaktig batteribyte.
Använd samma batterityp eller en ekvivalent typ som rekommenderas av apparattillverkaren.
Kassera använt batteri enligt fabrikantens instruktion.

VAROITUS

Paristo voi räjähtää, jos se on virheellisesti asennettu.
Vaihda paristo ainoastaan laitevalmistajan suosittelemaan tyyppiin. Hävitä käytetty paristo valmistajan ohjeiden mukaisesti.

For EU Countries



This product complies with the requirements of European Directive 89/336/EEC.

For the USA

FEDERAL COMMUNICATIONS COMMISSION RADIO FREQUENCY INTERFERENCE STATEMENT

This equipment has been tested and found to comply with the limits for a Class B digital device, pursuant to Part 15 of the FCC Rules. These limits are designed to provide reasonable protection against harmful interference in a residential installation. This equipment generates, uses, and can radiate radio frequency energy and, if not installed and used in accordance with the instructions, may cause harmful interference to radio communications. However, there is no guarantee that interference will not occur in a particular installation. If this equipment does cause harmful interference to radio or television reception, which can be determined by turning the equipment off and on, the user is encouraged to try to correct the interference by one or more of the following measures:

- Reorient or relocate the receiving antenna.
- Increase the separation between the equipment and receiver.
- Connect the equipment into an outlet on a circuit different from that to which the receiver is connected.
- Consult the dealer or an experienced radio/TV technician for help.

Unauthorized changes or modification to this system can void the users authority to operate this equipment.
This equipment requires shielded interface cables in order to meet FCC class B Limit.

For Canada

NOTICE

This Class B digital apparatus meets all requirements of the Canadian Interference-Causing Equipment Regulations.

AVIS

Cet appareil numérique de la classe B respecte toutes les exigences du Règlement sur le matériel brouilleur du Canada.

 Roland®

71453045

UPC 71453045



18961



 BOSS®

01452390

'03-2-G1-34TP