



# CL-50 COMPRESSOR LIMITER

## Owner's Manual

BOSS CL-50 COMPRESSOR LIMITER is a stereo unit that can be used in a variety of applications. It can be used as a compressor, limiter, or both. The unit is designed to provide a wide range of compression and limiting characteristics. The input and output levels are adjustable, and the threshold, ratio, attack, and release times can be set to suit the material being processed. The unit also features a gate function, which can be used to remove unwanted noise or to create a specific gate effect. The BOSS CL-50 is a versatile and high-quality piece of audio equipment that is suitable for use in a wide range of recording and live performance situations.

The BOSS CL-50 COMPRESSOR LIMITER is a stereo unit that can be used in a variety of applications. It can be used as a compressor, limiter, or both. The unit is designed to provide a wide range of compression and limiting characteristics. The input and output levels are adjustable, and the threshold, ratio, attack, and release times can be set to suit the material being processed. The unit also features a gate function, which can be used to remove unwanted noise or to create a specific gate effect. The BOSS CL-50 is a versatile and high-quality piece of audio equipment that is suitable for use in a wide range of recording and live performance situations.

The BOSS CL-50 COMPRESSOR LIMITER is a stereo unit that can be used in a variety of applications. It can be used as a compressor, limiter, or both. The unit is designed to provide a wide range of compression and limiting characteristics. The input and output levels are adjustable, and the threshold, ratio, attack, and release times can be set to suit the material being processed. The unit also features a gate function, which can be used to remove unwanted noise or to create a specific gate effect. The BOSS CL-50 is a versatile and high-quality piece of audio equipment that is suitable for use in a wide range of recording and live performance situations.

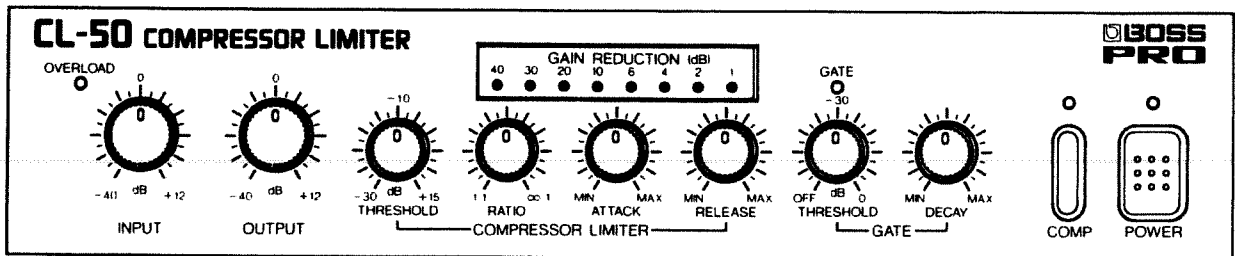

Thank you, and congratulations on your choice of the BOSS [CL-50] Compressor Limiter.

To make sure you enjoy the complete range of functions the CL-50 provides, and to ensure satisfaction for years to come, please take the time to completely read this Owner's Manual before starting out.

## ■ FEATURES

- The unit is a high-performance dynamic processor, which in addition to its compressor/limiter functions, also provides a gate function.
- A very favorable SN ratio and low distortion are assured thanks to the superior performance VCA that was selected for this unit. As a result, there is almost no deterioration in sound quality.
- The unit's operating status and the effect of various settings can be easily confirmed by viewing the Gain Reduction Indicators.
- The unit adapts readily to a wide range of applications since it is equipped with a Detector In Jack, as well as Stereo Link Jack. The former allows for the operational characteristics of the unit to change in correspondence with the signals arriving from the external source. The latter provides for the synchronization of two CL-50s.
- By employing the optional RAD-50 Rack Mount Adaptor, two units can be used together as a set which fits into a 1U space in a standard 19-inch rack.

**Copyright ©1990 by BOSS CORPORATION**

All rights reserved. No part of this publication may be reproduced in any form without the permission of ROLAND CORPORATION.

## ■ IMPORTANT NOTES

When using an AC adaptor, be sure that it is one supplied by the manufacturer. Use of any other power adaptor could result in damage, malfunction, or electric shock.

### Power Supply

- When making any connections with other devices, always turn off the power to all equipment first; this will help prevent damage or malfunction.
- Do not use this unit on the same power circuit with any device that will generate line noise, such as a motor or variable lighting system.
- The power supply required for this unit is shown on its nameplate. Ensure that the line voltage of your installation meets this requirement.
- Avoid damaging the power cord; do not step on it, place heavy objects on it etc.
- When disconnecting the AC adaptor from the outlet, grasp the plug itself, never pull on the cord.
- If the unit is to remain unused for a long period of time, unplug the power cord.

### Placement

- Do not subject the unit to temperature extremes (eg, direct sunlight in an enclosed vehicle). Avoid using or storing the unit in dusty or humid areas or areas that are subject to high vibration levels.
- Using the unit near power amplifiers (or other equipment containing large transformers) may induce hum.
- This unit may interfere with radio and television reception. Do not use this unit in the vicinity of such receivers.

### Maintenance

- For everyday cleaning wipe the unit with a soft, dry cloth (or one that has been slightly dampened with water). To remove stubborn dirt, use a mild neutral detergent. Afterwards, be sure to wipe the unit thoroughly with a soft, dry cloth.
- Never use benzene, thinners, alcohol or solvents of any kind, to avoid the risk of discoloration and/or deformation.

### Additional Precautions

- Protect the unit from strong impact.
- Do not allow objects or liquids of any kind to penetrate the unit. In the event of such an occurrence, discontinue use immediately. Contact qualified service personnel as soon as possible.
- Never strike or apply strong pressure to the display.
- Before using the unit in a foreign country, consult with qualified service personnel.
- Should a malfunction occur (or if you suspect there is a problem) discontinue use immediately. Contact qualified service personnel as soon as possible.

## ■ WHAT THE CL-50 CAN DO

The CL-50 is equipped to provide the features of three types of devices: Compressor, Limiter, and Gate. You will be able to use these features most effectively after first gaining a good understanding of how they work.

### < Compressor/Limiter >

While both of these act in compressing the input signal, factors such as the Threshold Level, Ratio, and the intended purpose result in their differentiation.

**Compressor:** Takes a divergent signal and compresses it, and when necessary, averages it to create sound of an amplitude that is perceived acoustically as being well-controlled.

**Limiter:** Serves in protecting equipment from excessively powerful input, and in preventing distortion.

#### ● Threshold Level

When using the Compressor/Limiter, the point at which it is to take effect is called the "Threshold Level". All signals of a level lower than the Threshold level are output without compression.

#### ● Ratio

The rate of compression to be applied with respect to the input signal is known as the "Ratio". For example, in a situation where a signal 10dB higher than a given signal is input, but at output there is only a 5 dB increase produced, there is a ratio of 10dB:5dB, or 2:1.

#### < Threshold Level and Ratio >

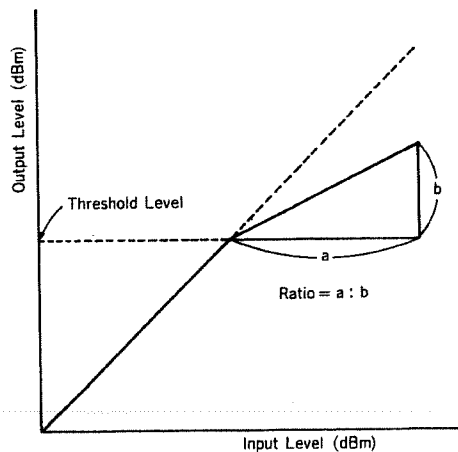

#### ● Attack Time

The Attack Time is the length of time it takes for compression to reach its set value, from the instant the signal being input has surpassed the Threshold Level.

#### ● Release Time

The Release Time is the length of time it takes for compression to be released and the signal to revert to normal, from the moment the signal drops below the Threshold Level.

#### < Attack Time and Release Time >

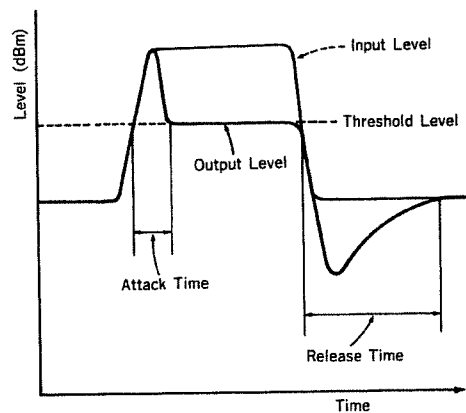

### < Gate >

Acts in muting signals that are below than the Threshold Level. This can conveniently be used to eliminate noise during periods of silence, or to mute unwanted sound while using microphones.

#### ● Gate Threshold Level

The level at which the Gate will start taking effect is known as the "Threshold Level".

#### ● Decay Time

When the input signal falls below the Threshold Level, the sound is muted. In actuality, a certain length of time is allowed to pass before the sound is cut off; this is called the "Decay Time" (attenuating time).

# MAKING CONNECTIONS

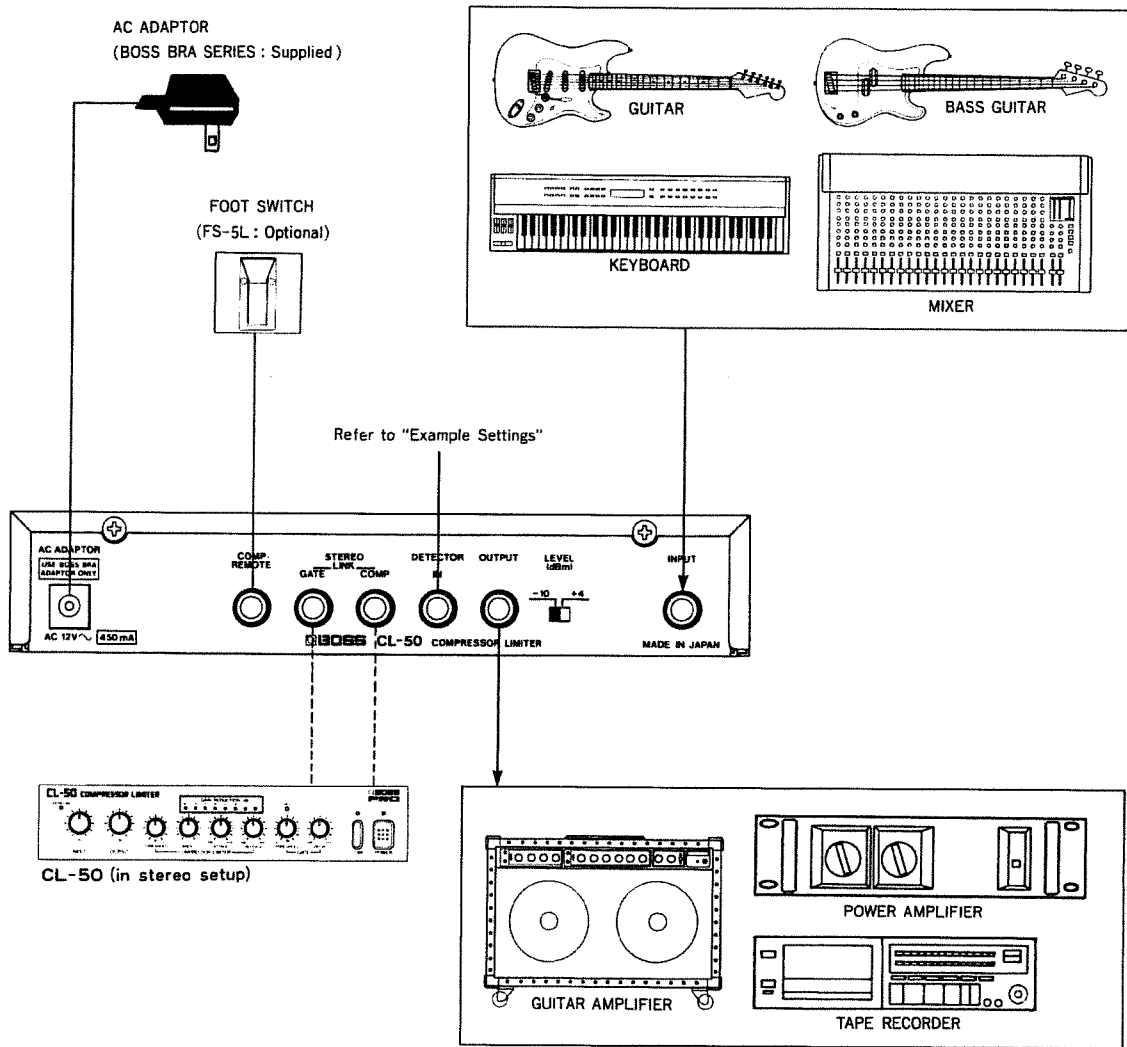

## ■ PANEL DESCRIPTIONS

### <Front Panel>

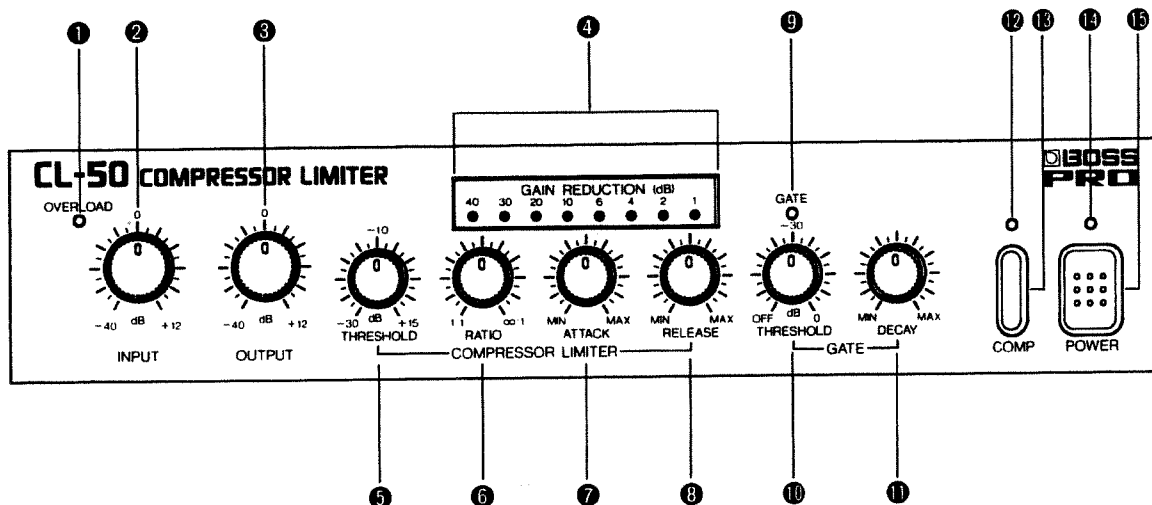

#### ❶ Overload Indicator

Lights when the input signal is too high.

- This indicator lights 6dB prior to the clipping point (level at which distortion starts to occur).

#### ❷ Input Level Knob

Provides for adjustment of the input level. Ordinarily it should be set to "0". However, in situations such as those described below, the knob may need to be adjusted.

- Should the Overload Indicator ❶ light too frequently, the input level is too high. Rotate the knob counterclockwise (↶) until the indicator lights only on input peaks.
- If you make a change in this level after settings for the Limiter and/or Gate Thresholds have been made, the level at which the effect is applied will change.

#### ❸ Output Level Knob

Used to determine the output level.

#### ❹ Gain Reduction Indicators

Provide indication of the degree of compression (dB) that applies when the Compressor/Limiter is operating.

Degree of Compression: Amount by which the input signal is compressed.

#### ❺ Limiter: Threshold Knob

This knob provides adjustment of the Threshold Level (level at which compression starts) for the Compressor/Limiter. When rotated counterclockwise (↶), the Threshold Level is lowered, and the effect of the Compressor/Limiter is increased.

#### ❻ Limiter: Ratio Knob

This knob is used to adjust the ratio of compression, that is, the extent to which signals above the Threshold Level will be compressed. When set to "1:1" there will be no effect obtained from the Compressor/Limiter.

Compression Ratio: The proportion, in respect to the input signal, for which compression takes place.

#### ❼ Limiter: Attack Knob

Provides for adjustment of the Attack Time (p.3). Clockwise rotation (↷) increases the Attack Time.

#### ❽ Limiter: Release Knob

Provides for adjustment of the Release Time (p. 3). Clockwise rotation (↷) increases the Release Time.

#### ❾ Gate Indicator

Lights when the input signal is below the Gate Threshold Level.

**10 Gate: Threshold Knob**

Adjusts the Threshold Level for the Gate. Clockwise rotation (↻), increases the Threshold Level. When set to "OFF," the Gate is disabled.

**11 Gate: Decay Knob**

Provides adjustment of the amount of time over which sound will decay after the input signals have dropped below the Threshold Level. Clockwise rotation increases the Decay Time.

**12 Comp Indicator**

Lights when the Comp/Gate is "In". Used to confirm whether it is switched "In" or "Out".

**13 Comp/Gate Switch**

Used to switch the Comp/Gate "In" or "Out". When the switch is In (↖), the input signal is routed through the Compressor/Limiter/Gate before being output. When the switch is Out (↗) the signal is output directly (bypassed).

**14 Power Indicator**

Lights when the Power Switch is turned on, indicating that the unit is ready for operation.

**15 Power Switch**

Turns power on or off. When "On" (↖), the Power Indicator lights indicating that the unit is ready for operation.

- **Make sure you turn the volume on your amplifier to "0" before turning the power switch on.**
- **No signal will be output from the unit for a few seconds after power is turned on since a muting circuit is in effect at that time.**

## <Rear Panel>

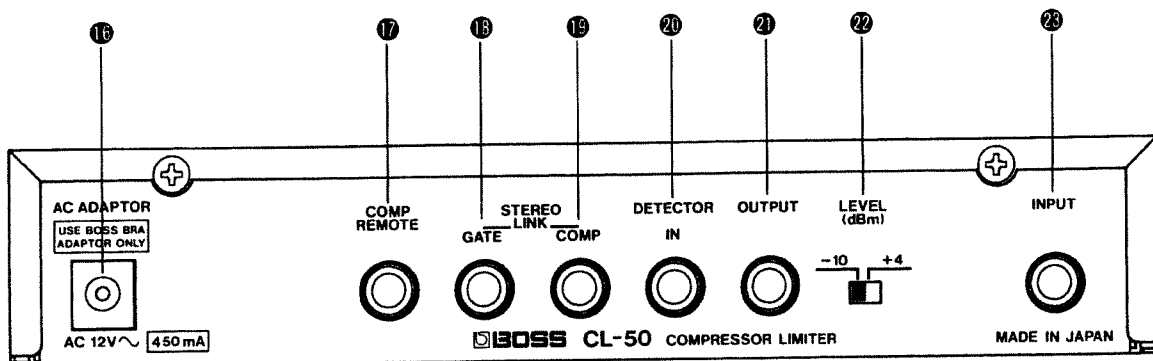

### 16 Adaptor Jack

This jack accepts connection of the supplied AC Adaptor (BOSS BRA - 120, 220, 240), specialized for use with this unit.

### 17 Comp Remote Jack

This jack accepts connection of an optionally available foot switch (FS - 5L). When connected, you have pedal control over switching the Comp/Gate In and Out. When using a foot switch, the Comp Indicator 12 indicates the In/Out status.

- If a foot switch is to be used, the Comp/Gate switch 15 on the front panel should first be set to "In" (—).

### 18 Gate: Stereo Link Jack

When you wish to use two CL-50s together, connection is made between this jack and its counterpart on the other unit. This provides you with identical response (manner in which effect is applied) from the Gate of both units, since they are then interlinked.

### 19 Comp: Stereo Link Jack

When using two CL-50s together, connection is made between this jack and its counterpart on the other unit. This provides you with identical response (manner in which effect is applied) from the Compressor/Limiter of each unit.

### 20 Detector In Jack

Used for input when you wish to have the various effects (Compressor/Limiter and/or Gate) controlled in a manner which correlates with the signal that arrives.

### 21 Output Jack

Output is provided from this jack.

### 22 Level Switch

This switch is used to select the rated input/output level. It should be set to either  $-10\text{dBm}$  or to  $+4\text{dBm}$ , depending on the level of the device you have connected. Ordinarily, with a guitar or other electronic musical instrument, you should set it to the " $-10\text{dBm}$ " position.

- A change in the Threshold Level settings 9 and 10 will occur as a result of changing the position of the Level Switch.

### 23 Input Jack

Input to the unit is made through this jack.

When using the unit without the optional Rack Mount Adaptor RAD-50, please attach the rubber feet as shown below.

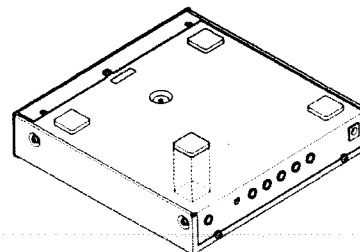



## ■ SETUP EXAMPLES

### ○ Limiter Applications

When connected before a tape deck in the recording chain, the CL-50 can help you obtain clear, distortion-free recordings. In addition, if connected before an amplifier, you can protect the amp from the damage that could result from extreme input levels.

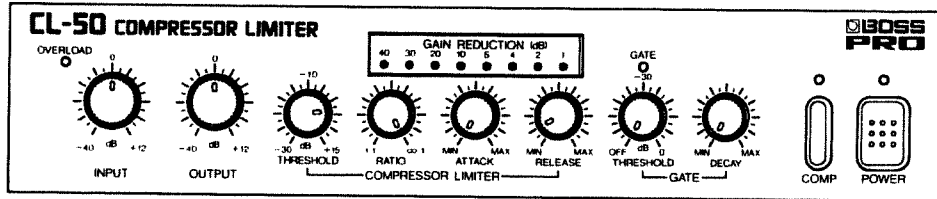

### ○ Use of Compressor with Vocals

Since vocals can have an extremely wide dynamic range, it is not that easy to obtain recordings that are free of distortion and have a good SN ratio. However, if a setup such as that shown below is used, you should be able to get clear, distortion-free recordings. At the same time, the perceived level of the vocal is raised, making it seem more pronounced.

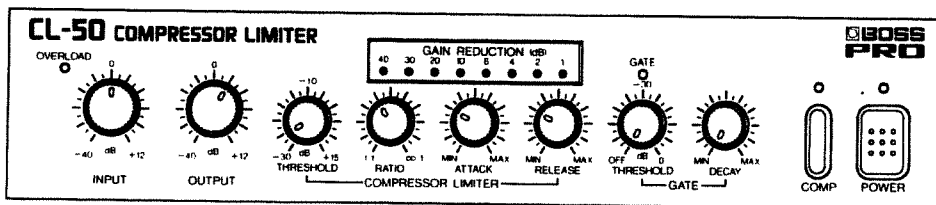

### ○ Use with Guitar or Bass

If used with a guitar when "rhythm playing" (quick rhythm strokes), you can produce a crisp, uniform sound. Additionally, with bass and a "chopper" (slap) technique, the peaks can be suppressed, creating a more balanced output from the instrument.

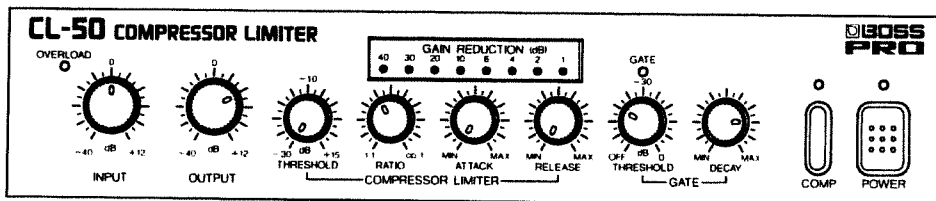

○ **Use as a Noise Gate**

When playing guitar or other instrument with a large number of effects units connected, there is usually a proportionate increase in the amount of noise produced. However, if you connect the CL-50 so it is located at the end of the signal path, you can effectively eliminate unwanted noise during moments when the instrument is not being played.

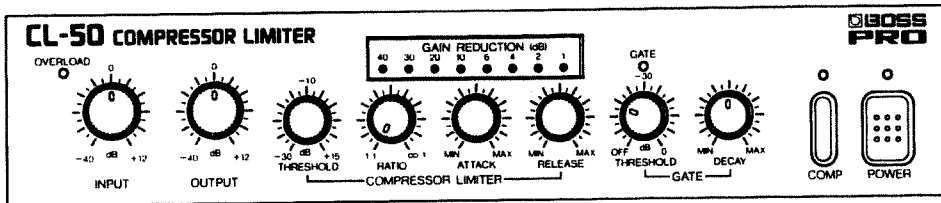

○ **Use as a Signal Gate**

When recording drums, using the unit on the bass drum can eliminate any unwanted lingering to create a tighter, punchier sound. In addition, when used with a microphone, you can eliminate stray sounds to obtain a cleaner recording.

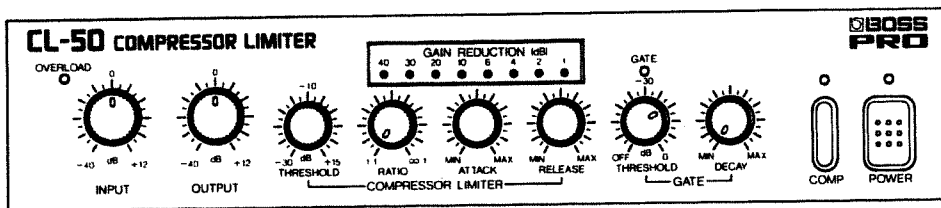

## ■ FURTHER APPLICATIONS FOR THE CL-50

Since the CL-50 is equipped with Detector In and Stereo Link jacks, it is capable of a wide-ranging assortment of additional applications.

### ○ Use as a De-esser with Vocals

When you wish to increase the clarity of vocals, one way would be to use an equalizer to boost the upper range. But this tends to emphasize the raspier elements as well, and can be unpleasant to listen to. As a solution, you can apply the Limiter to work only at about the 6 kHz frequency band, and eliminate the abrasive sounds without sacrificing any of the clarity.

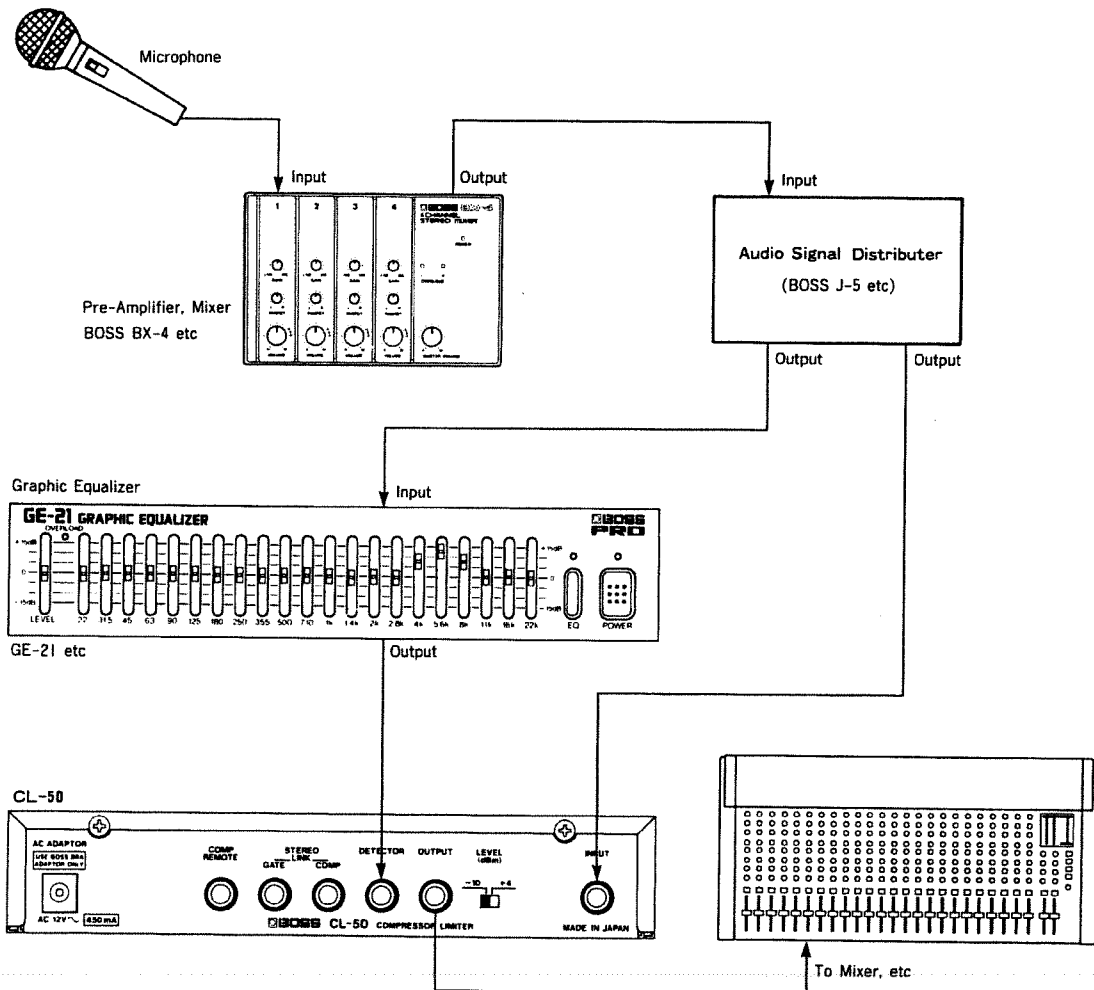
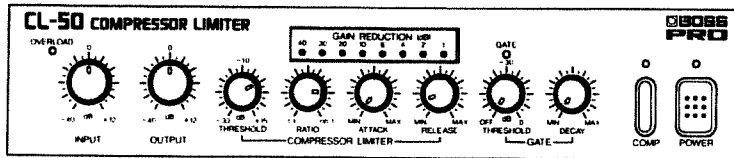

○ Use in Stereo as a Limiter

When working in stereo, you can use two CL-50s in tandem to obtain identical results for each channel. To do so, run a connection between the "Comp" jack (one of the Stereo Link jacks on the rear panel) and its counterpart on the other CL-50.

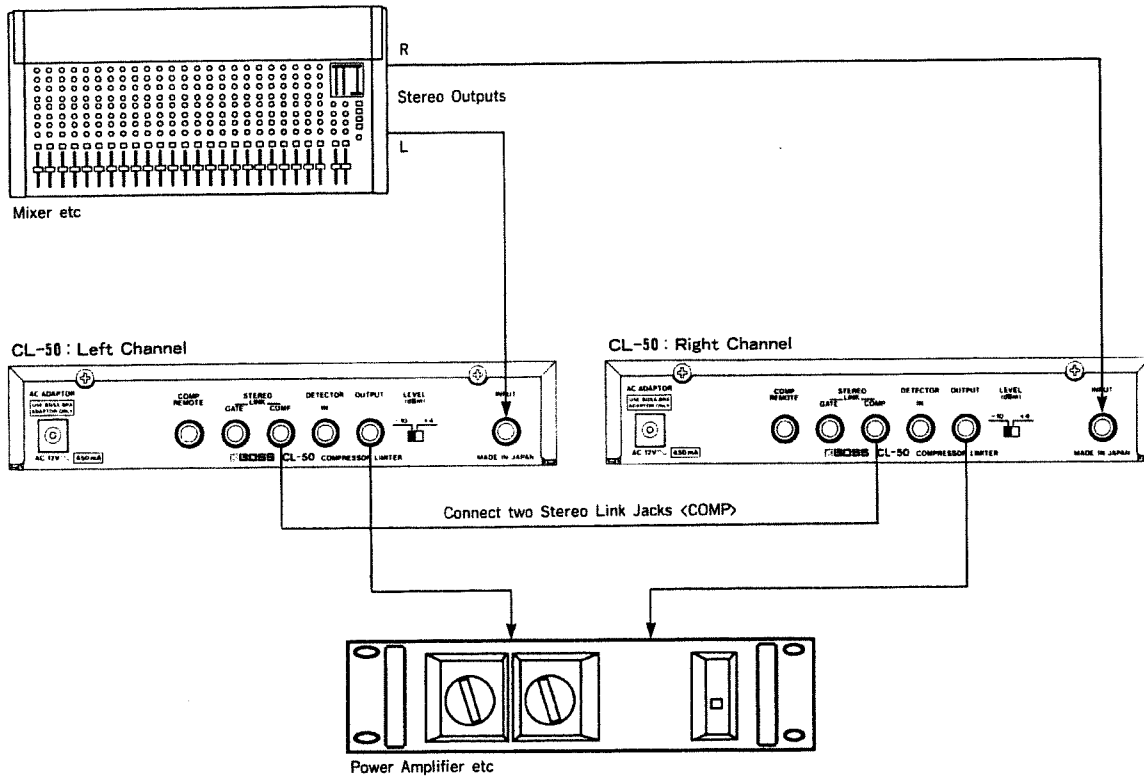
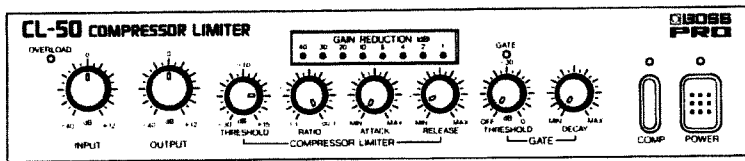

# ■ BLOCK DIAGRAM

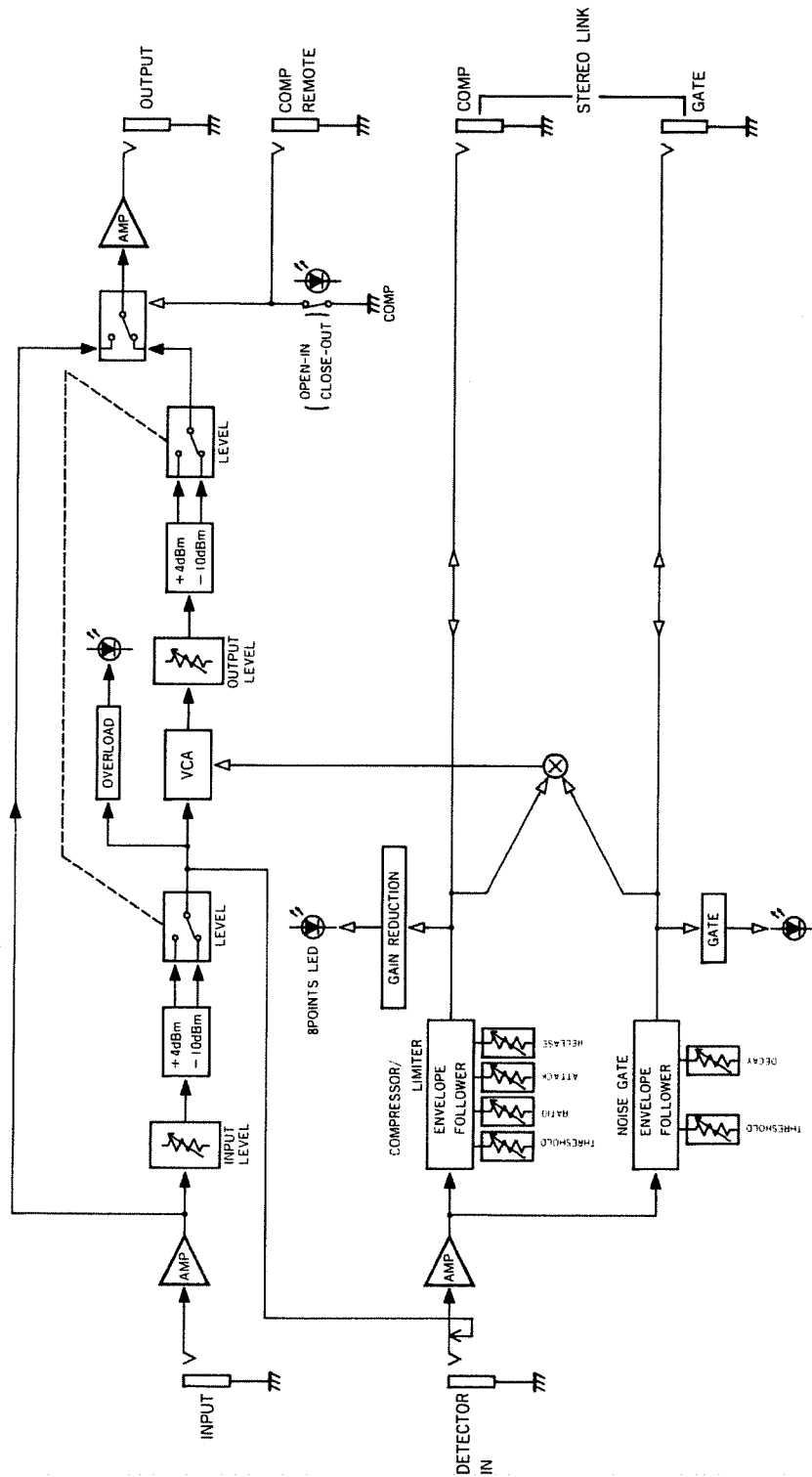

## ■ SPECIFICATIONS

**Rated Input Level:**  $-10\text{dBm}/+4\text{dBm}$

**Input Impedance:**  $1\text{M}\Omega$

**Rated Output Level:**  $-10\text{dBm}/+4\text{dBm}$

**Output Impedance:**  $600\Omega$

**Output Load Impedance:** over  $10\text{k}\Omega$

**Frequency Response:** (In)  $5\text{Hz}$  to  $35\text{kHz}$  ( $\pm 3\text{dB}$ )

**Residual Noise:** Less than  $-98\text{dBm}$  (IHF - A)  
(Level Switch:  $-10\text{dBm}$ )

**Total Harmonic Distortion:**  
Less than  $0.05\%$

**Input Gain:**  $-40$  to  $+12\text{dB}$

**Output Gain:**  $-40$  to  $+12\text{dB}$

**Detector In:**

(Rated Input Level):  $-10\text{dBm}$

(Input Impedance):  $47\text{k}\Omega$

**Compressor/Limiter**

**Threshold Level:**

$-40$  to  $+5\text{dBm}$  (Level Switch:  $-10\text{dBm}$ )

$-26$  to  $+19\text{dBm}$  (Level Switch:  $+4\text{dBm}$ )

**Ratio:**  $1:1$  to  $\infty:1$

**Attack Time:**  $50\mu\text{s}$  to  $200\text{ms}$

**Release Time:**  $70\text{ms}$  to  $1.5\text{s}$

**Gate**

**Threshold Level:**

$-\infty$  to  $-10\text{dBm}$  (Level Switch:  $-10\text{dBm}$ )

$-\infty$  to  $+4\text{dBm}$  (Level Switch:  $+4\text{dBm}$ )

**Decay Time:**  $25\text{ms}$  to  $20\text{s}$

**Controls:** Input Level, Output Level

**Compressor/Limiter:** Threshold, Ratio,  
Attack, Release

**Gate:** Threshold, Decay

**Switches:** Power, COMP In/Out, Level

**Indicators:** Power, COMP IN/Out, Overload, Gain  
Reduction, Gate

**Jacks:** Input, Output, Detector in, Stereo Link (Comp,  
Gate), COMP Remote, AC Adaptor In

**Power:**  $12\text{V AC}$  (BOSS BRA-120, 220, 240)

**Current Draw:**  $450\text{mA}$

**Dimensions:**  $218(\text{W}) \times 44(\text{H}) \times 235(\text{D})\text{mm}$   
 $8-5/8"(\text{W}) \times 1-3/4"(\text{H}) \times 9-5/16"(\text{D})$

**Weight:**  $1.4\text{kg}$  /  $3\text{lb}$   $2\text{oz}$

**Accessories:** AC Adaptor BOSS BRA-120, 220, 240  
Foot Rubber  $\times 4$

**Options:** Rack Mount Adaptor RAD-50

※ Not attachable to Rack Mount Adaptor RAD  
-10.

Foot Switch FS-5L

\* In the interest of product improvement, the specifications of this unit are subject to change without prior notice.

# Information

● When you need repair service, call your local Roland Service Station or the authorized Roland distributor in your country as shown below.

## U. S. A.

Roland Corp US  
7200 Dominion Circle  
Los Angeles, CA. 90040 - 3647  
U. S. A.  
☎ (213)685 - 5141

## CANADA

Roland Canada Music Ltd.  
(Head Office)  
13880 Mayfield Place  
Richmond B. C., V6V 2E4  
CANADA  
☎ (604)270 - 6626

Roland Canada Music Ltd.  
9425 Transcanadienne  
Service Rd. N.,  
St Laurent, Quebec H4S 1V3  
CANADA  
☎ (514)335 - 2009

Roland Canada Music Ltd.  
346 Watline Avenue,  
Mississauga, Ontario L4Z 1X2  
CANADA  
☎ (416)890 - 6488

## AUSTRALIA

Roland Corporation  
(Australia) Pty. Ltd.  
(Head Office)  
38 Campbell Avenue  
Dee Why West. NSW 2099  
AUSTRALIA  
☎ (02)982 - 8266

Roland Corporation  
(Australia) Pty. Ltd.  
(Melbourne Office)  
50 Garden Street  
South Yarra, Victoria 3141  
AUSTRALIA  
☎ (03)241 - 1254

## NEW ZEALAND

Roland Corporation (NZ) Ltd.  
97 Mt. Eden Road, Mt. Eden,  
Auckland 3  
NEW ZEALAND  
☎ (09)398 - 715

## UNITED KINGDOM

Roland(UK)Ltd.  
Amalgamated Drive  
West Cross Centre, Brentford,  
Middlesex TW8 9EZ,  
UNITED KINGDOM  
☎ (81)568 - 4578

## WEST GERMANY

Roland Elektronische  
Musikinstrumente  
Handelsgesellschaft mbH.  
Oststrasse 96,  
2000 Norderstedt  
WEST GERMANY  
☎ 040/52 60 090

## BELGIUM/HOLLAND/ LUXEMBOURG

Roland Benelux N. V.  
Houtstraat 1  
B - 2431 Oevel - Westerlo  
BELGIUM  
☎ 014 - 58 45 35

## DENMARK

Roland Scandinavia A/S  
Langebrogade 6  
Box 1937  
DK - 1023 Copenhagen K.  
DENMARK  
☎ 31 - 95 31 11

## SWEDEN

Roland Scandinavia A/S  
DanvikCenter 28 A., 2 tr.  
S - 131 30 Nacka,  
SWEDEN  
☎ 08 - 702 00 20

## NORWAY

Roland Scandinavia  
Ave. Norge  
Lilleakerveien 2  
Postboks 95 Lilleaker  
N - 0216 Oslo 2  
NORWAY  
☎ 02 - 73 00 74

## FINLAND

Fazer Musik Inc.  
Länsituulentie  
POB 169  
SF - 02101 Espoo  
FINLAND  
☎ 0 - 43 50 11

## ITALY

Roland Italy S. P. A.  
Viale delle Industrie 8  
20020 ARESE MILANO  
ITALY  
☎ 02 - 93581311

## SPAIN

Roland Electronics  
de España S. A.  
Bolivia 239  
08020 Barcelona  
SPAIN  
☎ 93 - 308 - 1000

## SWITZERLAND

Musitronic AG  
Gerberstrasse 5, CH - 4410  
Liestal  
SWITZERLAND  
☎ 061/921 16 15

Roland CK (Switzerland) AG  
Hauptstrasse 21  
CH - 4456 Tenniken  
SWITZERLAND  
☎ 061/98 60 55  
Repair Service by Musitronic AG

## FRANCE

Musikengro  
102, Avenue Jean - Jaures  
69007 Lyon Cedex 07  
FRANCE  
☎ (7)858 - 54 60

Musikengro  
(Paris Office)  
Centre Region Parisienne  
41 rue Charles - Fourier,  
94400 Vitry s/Seine  
FRANCE  
☎ (1)4680 86 62

## AUSTRIA

E. Dematte & Co.  
Neu - Rum Siemens - Strasse 4  
A - 6021 Innsbruck Box 591  
AUSTRIA  
☎ 43(05222)63 451

## GREECE

V. Dimitriadis & Co. Ltd.  
2 Fidiou Str., GR 106 78  
Athens  
GREECE  
☎ 3620130

## PORTUGAL

Casa Caius Instrumentos  
Musicais Lda.  
Rua de Santa Catarina 131  
Porto  
PORTUGAL  
☎ 02 - 38 44 56

## HUNGARY

Intermusica Ltd.  
Warehouse Area 'DEPO'  
Budapest. P.O. Box 3,  
2045 Torokbalint  
Budapest  
HUNGARY  
☎ 1868905

## BRAZIL

Oliver do Brazil S.A.  
Instrumentos Musicais  
Rua Ludovico Ariostos, 55  
Butanta Cep. 05542,  
Sao Paulo - SP  
BRAZIL  
☎ 5511 869 2561

As of JUL. 11. 1990

 Roland®

**2604022200**

UPC 2604022200



1898:

 **BOSS**  
Products of Roland

2604022200 '90-8-CA2-12SE(AX)