

# LK-135

# LK-136

EN/ES

English

Español

## USER'S GUIDE

Please keep all information for future reference.

### Safety Precautions

Before trying to use the Digital Keyboard, be sure to read the separate "Safety Precautions".

## GUÍA DEL USUARIO

Guarde toda la información para futuras consultas.

### Precauciones de seguridad

Antes de intentar usar el teclado digital, asegúrese de leer las "Precauciones de seguridad" separadas.

### About Music Score data

You can use a computer to download music score data from the CASIO Website. For more information, visit the URL below.

<http://world.casio.com/>

### Acerca de los datos de partituras

Puede utilizar un ordenador (computadora) para descargar los datos de partituras desde el sitio web de CASIO. Para obtener más información, visite la siguiente URL.

<http://world.casio.com/>

## NOTICE

This equipment has been tested and found to comply with the limits for a Class B digital device, pursuant to Part 15 of the FCC Rules. These limits are designed to provide reasonable protection against harmful interference in a residential installation. This equipment generates, uses and can radiate radio frequency energy and, if not installed and used in accordance with the instructions, may cause harmful interference to radio communications. However, there is no guarantee that interference will not occur in a particular installation. If this equipment does cause harmful interference to radio or television reception, which can be determined by turning the equipment off and on, the user is encouraged to try to correct the interference by one or more of the following measures:

- Reorient or relocate the receiving antenna.
- Increase the separation between the equipment and receiver.
- Connect the equipment into an outlet on a circuit different from that to which the receiver is connected.
- Consult the dealer or an experienced radio/TV technician for help.

## FCC CAUTION

Changes or modifications not expressly approved by the party responsible for compliance could void the user's authority to operate the equipment.

## Declaration of Conformity

Model Number: LK-135/LK-136

Trade Name: CASIO COMPUTER CO., LTD.

Responsible party: CASIO AMERICA, INC.

Address: 570 MT. PLEASANT AVENUE, DOVER, NEW JERSEY 07801

Telephone number: 973-361-5400

This device complies with Part 15 of the FCC Rules, Operation is subject to the following two conditions:

(1) This device may not cause harmful interference, and (2) this device must accept any interference received, including interference that may cause undesired operation.

## Important!

Please note the following important information before using this product.

- Before using the optional AD-E95100L Adaptor to power the unit, be sure to check the AC Adaptor for any damage first. Carefully check the power cord for breakage, cuts, exposed wire and other serious damage. Never let children use an AC adaptor that is seriously damaged.
- Never attempt to recharge batteries.
- Do not use rechargeable batteries.
- Never mix old batteries with new ones.
- Use recommended batteries or equivalent types.
- Always make sure that positive (+) and negative (-) poles are facing correctly as indicated near the battery compartment.
- Replace batteries as soon as possible after any sign they are getting weak.
- Do not short-circuit the battery terminals.
- The product is not intended for children under 3 years.
- Use only CASIO AD-E95100L adaptor.
- The AC adaptor is not a toy.
- Be sure to disconnect the AC adaptor before cleaning the product.

Declaration of Conformity According to EU Directive



Manufacturer:  
CASIO COMPUTER CO., LTD.  
6-2, Hon-machi 1-chome, Shibuya-ku, Tokyo 151-8543, Japan

Responsible within the European Union:  
Casio Europe GmbH  
Casio-Platz 1, 22848 Norderstedt, Germany  
[www.casio-europe.com](http://www.casio-europe.com)

- Any reproduction of the contents of this manual, either in part or its entirety, is prohibited. Except for your own, personal use, any other use of the contents of this manual without the consent of CASIO is prohibited under copyright laws.
- IN NO EVENT SHALL CASIO BE LIABLE FOR ANY DAMAGES WHATSOEVER (INCLUDING, WITHOUT LIMITATION, DAMAGES FOR LOSS OF PROFITS, BUSINESS INTERRUPTION, LOSS OF INFORMATION) ARISING OUT OF THE USE OF OR INABILITY TO USE THIS MANUAL OR PRODUCT, EVEN IF CASIO HAS BEEN ADVISED OF THE POSSIBILITY OF SUCH DAMAGES.
- The contents of this manual are subject to change without notice.
- The actual appearance of the product may be different from that shown in the illustrations in this User's Guide.
- Company and product names used in this manual may be registered trademarks of others.

# Contents

<b>General Guide</b>	<b>EN-2</b>
Timeout	EN-4
Using the 10-key Pad (9)	EN-4
Using the FUNCTION Button (12)	EN-4
<b>Getting Ready to Play</b>	<b>EN-7</b>
Preparing the Music Stand	EN-7
Power Supply	EN-7
<b>Playing the Digital Keyboard</b>	<b>EN-8</b>
Turning on Power and Playing	EN-8
Playing the Demo Songs	EN-8
Using Headphones	EN-8
Turning Off Keyboard Lighting (KeyLight)	EN-8
<b>Controlling the Keyboard Sounds</b>	<b>EN-9</b>
Select from a variety of musical instrument sounds	EN-9
<b>Playing in the Dance Music Mode</b>	<b>EN-10</b>
Dance Music Mode	EN-10
Switch Keyboard Functions	EN-10
Using the Dance Music Mode	EN-11
Creating a Build Up	EN-11
Dance Music Mode Settings	EN-12
<b>Playing Built-in Songs</b>	<b>EN-12</b>
Playing Back a Particular Song	EN-12
<b>Using Built-in Songs to Master Keyboard Play</b>	<b>EN-14</b>
Easy Mode	EN-14
Lesson Lite	EN-14
Settings You Can Use During Lesson Lite	EN-14
<b>Using Auto Accompaniment</b>	<b>EN-15</b>
Playing the Rhythm Part only	EN-15
Playing All Parts	EN-15
Using Auto Accompaniment Effectively	EN-17
<b>Connecting External Devices</b>	<b>EN-17</b>
Connecting to Audio Equipment	EN-17
<b>Reference</b>	<b>EN-18</b>
Troubleshooting	EN-18
Returning the Digital Keyboard to Its Factory Default Settings	EN-19
Specifications	EN-20
Operating Precautions	EN-21

<b>Appendix</b>	<b>A-1</b>
Tone List	A-1
Drum Assignment List	A-2
Rhythm List	A-3
Song List	A-4
Dance Music Mode List	A-5
Fingering Guide	A-6
Chord Example List	A-7

## Included Accessories

- Music Stand
- Leaflets
  - Safety Precautions
  - Other (Warranty, etc.)

Items included as accessories are subject to change without notice.

## Separately Available Accessories



- You can get information about accessories that are separately for this product from the CASIO catalog available from your retailer, and from the CASIO website at the following URL.

<http://world.casio.com/>

# General Guide

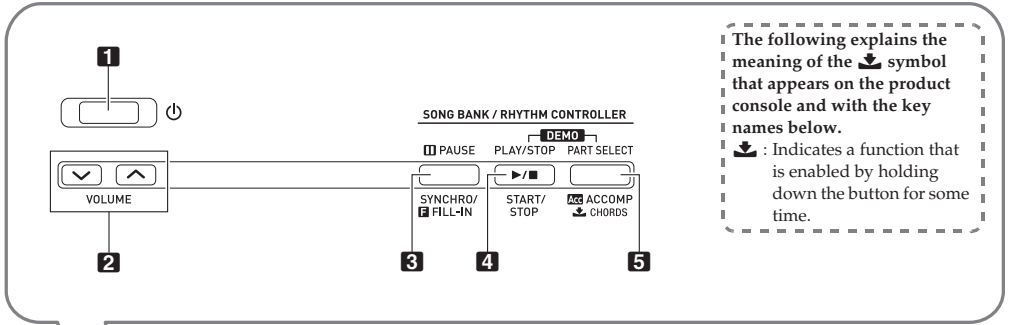
• Illustrations in this User's Guide show the LK-135.



The following explains the meaning of the  symbol that appears on the product console and with the key names below.  
 : Indicates a function that is enabled by holding down the button for some time.

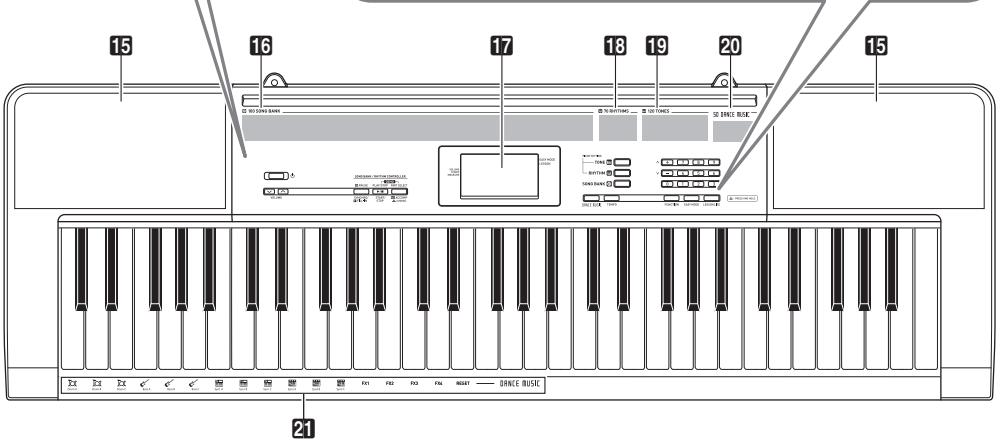
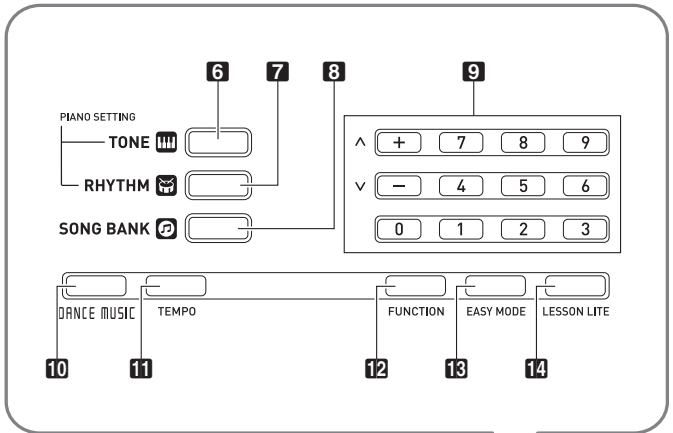

- 1** **⏻** (Power) button EN-8
- 2** **VOLUME** buttons EN-8
- 3** **⏸** **PAUSE, SYNCHRO/FILL-IN** button EN-12, 17
- 4** **▶** **PLAY/STOP, START/STOP** button EN-12, 13, 15
- 5** **⏮** **PART SELECT, ACCOMP, CHORDS** button EN-13, 15, 16
- 6** **TONE** button EN-9, 13
- 7** **RHYTHM** button EN-15
- 8** **SONG BANK** button EN-12
- 9** Number buttons, **[-]/[+]** keys EN-4
- 10** **DANCE MUSIC** button EN-11
- 11** **TEMPO** button EN-11, 13
- 12** **FUNCTION** button EN-4
- 13** **EASY MODE** button EN-14
- 14** **LESSON LITE** button EN-14
- 15** Speakers
- 16** Song Bank list
- 17** Display
- 18** Rhythm list
- 19** Tone list
- 20** Dance Music Track list
- 21** Dance Music tone

■ Back

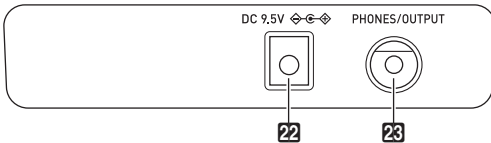

**22** DC 9.5V terminal EN-7

**23** PHONES/OUTPUT jack EN-8, 17

■ Display

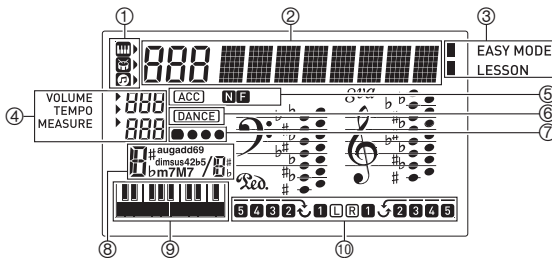

- ① Tone, rhythm, song bank indicators
  - ② Number, setting name/status display
  - ③ Indicators
  - ④ Volume, Tempo, measure
  - ⑤ N F (Auto Accompaniment Types) indicators\*,  
Acc (Auto Accompaniment) indicator
  - ⑥ Dance Music Mode indicator
  - ⑦ Beat display
  - ⑧ Chord name
  - ⑨ Pattern phrase keyboard/chord keyboard
  - ⑩ Part, fingering display
- \* N:Normal, F:Fill-in

## Timeout

If you do not perform any operation for a while configuring settings, the display will return to the previous screen automatically.

## Using the 10-key Pad (9)

Use the number buttons and the [-] and [+] keys to change displayed numbers and settings.

### Number Buttons

Use the number buttons to enter numbers and values.

- Enter the same number of digits as the currently displayed value.

Example: To enter tone number 004, input 0 → 0 → 4.

### NOTE

- Negative values cannot be input using the number buttons. Use [+] (increase) and [-] (decrease) instead.

### [-] and [+] Keys

You can use the [+] (increase) and [-] (decrease) keys to change the displayed number or value.

- Holding down either key scrolls the displayed setting.
- Pressing both keys at the same time will revert to the initial default setting or the recommended setting.

## Using the FUNCTION Button (f2)

Use this button to change the volume level and pitch, and to configure other settings.

- Press **f2 FUNCTION**.
- Next, press **f2 FUNCTION** the number of times required to select the setting you want to change. Each press of **f2 FUNCTION** cycles through the available parameters.

### NOTE

- You can also scroll back through settings by holding down **f2 FUNCTION** and pressing **f8 EASY MODE**.

<b>f2</b> key presses	Parameter	Display	Description
1	Transpose	Trans.	Changes (transposes) overall instrument tuning by semitone units. <b>-12 to +12</b> (semitone units, one octave up/down)
2	Accompaniment Volume	AcompVol	Changes the Auto Accompaniment volume.
3	Song Volume	Song Vol	Changes the song playback volume.
4	Dance Music Volume	DM Vol.	Changes the dance music song playback volume.
5	Dance Music Sync Type	DM Sync	Sets the timing of dance music syncing. <b>1:</b> No misalignment of phrase playback between each part, regardless of pattern phrase switch timing. <b>2:</b> Start pattern phrase playback to match timing of the pattern switching keyboard key. If there is misalignment with the playback timing of the pattern phrase between parts, alignment will be adjusted automatically measure-by-measure as playback proceeds.

f2 key presses	Parameter	Display	Description
6	Dance Music Tempo Setting	DM Tempo	<p>Specifies whether or not the performance tempo changes to the value that is preset for each pattern.</p> <p><b>on:</b> When the pattern is switched, the performance tempo changes to the tempo suggested for the selected pattern. Since the tempo changes, melody can be completely changed.</p> <p><b>off:</b> Even if the pattern is switched, the performance tempo remains at its current setting, without changing.</p> <p>Tempo does not change suddenly, which enables natural pattern connection.</p>
7	Dance Music Tone Setting	DM Tone	<p>Specifies whether or not the keyboard tone changes to the tone that is preset for each pattern.</p> <p><b>on:</b> When the pattern is switched, the tone changes to the tone suggested for the selected pattern. Select this setting when you want to change the performance tone whenever the pattern changes.</p> <p><b>off:</b> Even if the pattern is switched, the tone remains at its current setting, without changing. Select this setting when you want the same tone to play even if the pattern changes.</p>
8	Voice Fingering Guide	Speak	<p>Enables or disables Voice Fingering Guide, which uses a voice to tell you which finger to use to play each note during Lesson Lite.</p> <p><b>on:</b> Voice Fingering Guide enabled.</p> <p><b>off:</b> Voice Fingering Guide disabled.</p>
9	Note Guide	NoteGuid	<p>Enables or disables Note Guide, which sounds each note you need to play during a Lesson Lite.</p> <p><b>on:</b> Note Guide enabled.</p> <p><b>off:</b> Note Guide disabled.</p>
10	Performance Evaluation	Scoring	<p>Enables or disables Performance Evaluation, which displays scores for your Lesson Lite results.</p> <p><b>on:</b> Performance Evaluation enabled.</p> <p><b>off:</b> Performance Evaluation disabled.</p>
11	Keyboard Lighting	KeyLight	<p>Enables or disables Keyboard Lighting, which is a function that causes keyboard keys to light in order to guide note play.</p> <p><b>on:</b> Keyboard Lighting enabled.</p> <p><b>off:</b> Keyboard lighting disabled.</p>
12	Power On Alert	Demo2	<p>Keyboard keys will light to remind you that power is on if you do not perform any operation for about six minutes. You can disable power on alert to ensure that keyboard keys do not light during a concert, etc.</p> <p><b>on:</b> Keyboard keys light after six minutes of non-operation.</p> <p><b>off:</b> Keyboard keys do not light after six minutes of non-operation.</p>
13	Tuning	Tune	<p>Makes slight adjustments to the overall pitch. Use this feature to adjustment Digital Keyboard tuning to another musical instrument or to playback from a CD. This setting is the frequency of A4 (A above middle C). See the notes under "IMPORTANT!" below.</p> <p><b>415.5 to 465.9 Hz</b> (Initial Default: 440.0 Hz)</p>

<b>f2</b> key presses	Parameter	Display	Description
14	LCD Contrast	Contrast	Adjusts display contrast. <b>1 to 12:</b> A larger value makes the display contrast darker.
15	Auto Power Off	APO	Setting that controls whether or not the Digital Keyboard turns off automatically after a period of non-use. <b>OFF:</b> Auto Power off disabled. <b>30:</b> The Digital Keyboard turns off automatically after 30 minutes of non-use.

**3.** When the parameter you want is displayed, use **9** (10-key) to change its setting.

### **IMPORTANT!**

- The tone and other parameters revert to their initial defaults whenever you turn on power. The main volume, and Tuning, LCD Contrast, and Auto Power Off settings are automatically saved and retained when power is turned off.
- You can use the [+] and [-] buttons to input a value to the right of a decimal point.  
To specify 442.2 Hz, for example, first use the number buttons to input 4 → 4 → 2. Next, press the [+] button twice.



## Getting Ready to Play

### Preparing the Music Stand

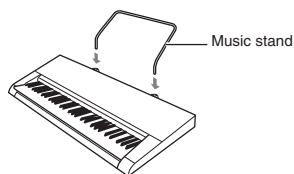

### Power Supply

Either an AC adaptor or batteries can be used to power this Digital Keyboard. Normally, use of AC adaptor power is recommended.

- Depending on your geographical area, an AC adaptor may not be included. In this case, will need to purchase an AC adaptor from your retailer.

### Using the AC Adaptor

Make sure that you use only the AC adaptor specified for this Digital Keyboard. Use of a different type of AC adaptor can cause malfunction.

**Specified AC Adaptor: AD-E95100L**  
(JEITA Standard plug)

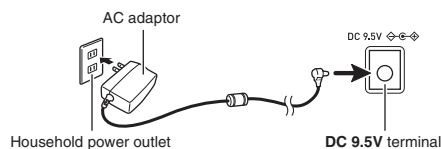

### IMPORTANT!

- Be sure to turn off Digital Keyboard power before connecting or disconnecting the AC adaptor.
- The AC adaptor will become warm to the touch after very long use. This is normal and does not indicate malfunction.
- To prevent breaking of the wire, take care to avoid putting any type of load on the power cord.

**No bending!**



**No winding!**

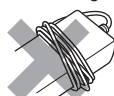

- Never insert metal, pencils, or any other objects into the product's 9.5V DC terminal. Doing so creates the risk of accident.

### Using Batteries

#### IMPORTANT!

- Be sure to turn off power before loading batteries.
- It is up to you to prepare six commercially available AA-size batteries. Do not use oxyride batteries or any other nickel based batteries.

1. Open the battery cover on the bottom of the Digital Keyboard.
2. Load six AA-size batteries into the battery compartment.  
Make sure the positive ⊕ and negative ⊖ ends of the batteries are facing as shown in the illustration.
3. Insert the tabs of the battery cover into the holes on the side of the battery compartment, and close the cover.

#### Low Battery Indication

The indicator shown below starts to flash to let you know when battery power is low. Replace the batteries with new ones.

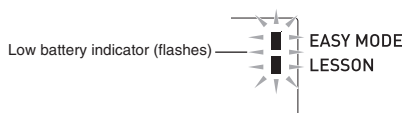

## Playing the Digital Keyboard

### Turning on Power and Playing

#### 1. Press **1** (Power).

This turns on power.

- To turn off the Digital Keyboard, hold down the **1**  (Power) button until the Digital Keyboard's display goes blank.

#### 2. Try playing something on the keyboard. You could use **2** **VOLUME** to adjust the volume setting.

- This causes the volume indicator, which shows the current volume level, to appear on the display.

#### **IMPORTANT!**

- Turning off power causes tone, rhythm, and other settings (except for main volume, the Tuning, LCD Contrast, and Auto Power Off settings) to return to their initial defaults.

### Playing the Demo Songs

Following playback of the dance music demo (000), the built-in songs will playback sequentially from 001 to 100. You can switch to a different song while playback is in progress.

#### 1. Press **4** **PLAY/STOP, START/STOP** and **5** **PART SELECT, ACCOMP, CHORDS** at the same time.

This will start playback of the demo songs. Demo playback continues until you stop it.

- Demo songs always start from song number 000 (dance music demo song).
- See page A-4 for a complete list of available songs.

#### 2. To change to another song while demo playback is in progress, use **9** (10-key) [-] and [+] keys to enter the song number you want (page EN-4).

This will cause demo playback to jump to the song whose number you entered.

- You cannot use **9** (10-key) number buttons to select a song.

#### 3. To stop demo playback, press **4** **PLAY/STOP, START/STOP**.

Demo playback continues until you stop it by pressing

- 4** **PLAY/STOP, START/STOP**.

## Using Headphones

Using headphones cuts off output from the built-in speakers, which means you can practice playing even late at night without disturbing others.

- Be sure to turn down the volume level before connecting headphones.

#### **NOTE**

- Headphones do not come with the Digital Keyboard.
- Use commercially available headphones. See page EN-1 for information about options.

#### **IMPORTANT!**

- Do not listen to very high volume output over headphones for long period. Doing so creates the risk of hearing damage.
- If the plug of the headphones you are using does not match the **28** **PHONES/OUTPUT** jack, use the applicable commercially available adaptor plug.
- If you are using headphones that require an adaptor plug, make sure you do not leave the adaptor plugged in when removing the headphones.

### Turning Off Keyboard Lighting (KeyLight)

See "Using the **FUNCTION** Button (**12**)" (page EN-4).

# Controlling the Keyboard Sounds

## Select from a variety of musical instrument sounds

### To select an instrument for playing

1. Press **6** TONE.
2. Use **9** (10-key) to select the tone number you want.  
The corresponding tone number and tone name will appear on the screen.

#### NOTE

- For a list of tones, see the “Tone List” (page A-1).
- Selecting a drum set tone causes various percussion instruments to be assigned to keyboard keys.

3. Try playing something on the keyboard.  
You can play the tone of a selected instrument.

### Playing with a Piano Tone (Piano Setup)

Press **7** RHYTHM and **6** TONE at the same time.  
This selects tone 001 GRAND PIANO, and changes other settings so they are appropriate for piano performance.

# Playing in the Dance Music Mode

## Dance Music Mode

In the Dance Music Mode, you can combine and play multiple type of pattern phrases, and apply effects to songs that are playing, in order to enjoy dance music.

Pattern phrases of each part can be combined, making it possible to enjoy dance music like a DJ.

Entering the Dance Music Mode (page EN-11) changes the functions of the keyboard keys as shown below.

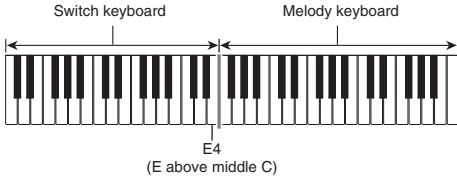

## Switch Keyboard Functions

The keys of the left-half switch keyboard have the functions below.

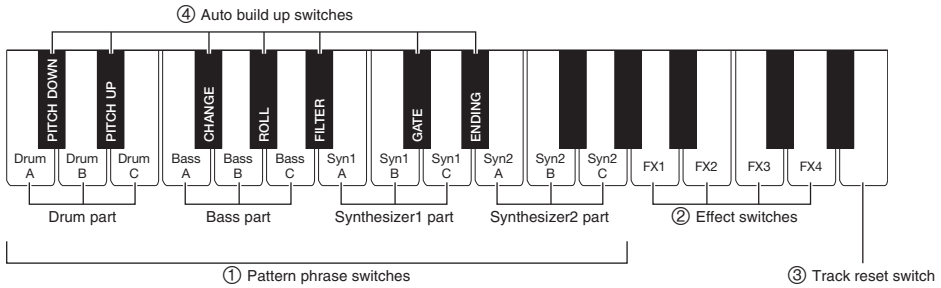

### ① Pattern phrase switches

These keys switch the pattern phrase and turn pattern phrases on or off.

There are four parts: Drum, Bass, Synth 1 and Synth 2, three different pattern phrases can be assigned to each.

### ② Effect switches

While an Effect Switch key is depressed, the corresponding effect (described below) is applied to the entire song.

Keyboard Key	Function	Effect, Description
FX1	MOD LPF*1	Cuts the high-range frequencies of the sound.
FX2	MOD HPF*2	Cuts the low-range frequencies of the sound.
FX3	FLANGER	Applies an undulating surge effect to the sound.
FX4	LO-FI	Reduces the resolution of the sound.

\*1 Modulation Low Pass Filter

\*2 Modulation High Pass Filter

### NOTE

- The display shows the applicable function name while an effect is being applied.
- An effect is applied as long as its keyboard key is depressed, and stops being applied when the key is released.
- The application manner of MOD LPF and MOD HPF changes with the tempo.
- Effects are applied to overall pattern play, and cannot be applied to individual parts.

### ③ Track reset switch

Pressing this key while playback is in progress returns playback to the beginning of the currently playing phrase.

### ④ Auto build up switches

These keyboard keys can be used to apply build up effects that are a characteristic of dance music. See “Creating a Build Up” (page EN-11).

## Using the Dance Music Mode

1. Press **F10** DANCE MUSIC.
2. Use the **F9** (10-key) [-] and [+] keys to select a pattern.

#### NOTE

- For a list of patterns, see the “Dance Music Mode List” (page A-5).
- Changing the pattern normally causes the tempo and tone to change to the settings configured for each pattern. If you do not want these settings to change, see “Dance Music Tempo Setting” (page EN-4) and “Dance Music Tone Setting” (page EN-4).

3. Press a **F1** Pattern phrase switch.

This starts pattern play.

Now you can press other part pattern phrase keys to increase the parts that are sounding, change to a different phrase, and configure other combinations.

4. Pressing a keyboard key that corresponds to a pattern phrase that is sounding stops the phrase.
  - You can also start and stop pattern playback by pressing **F4** START/STOP in step 3.

#### NOTE

- The key and the indicator of the on-screen keyboard key that corresponds to the pattern phrase that is playing light.
- Melody keyboard keys do not light in the Dance Music Mode.
- Pressing a keyboard key to which an effect is assigned applies the effect.

## Changing the Melody Keyboard Tone

After pressing **F6** TONE, use the **F9** (10-key) [-] and [+] keys to select a tone for the right-half melody keyboard. Hold down **F6** TONE to select the tone recommended for the selected pattern.

#### NOTE

- Press **F10** DANCE MUSIC to return to the pattern selection screen.

## Changing the Tempo

1. Press the **F11** TEMPO button.  
This displays current tempo value along with the text “TEMPO”.
2. Use the **F9** (10-key) [-] and [+] keys to change the tempo value.
3. After the setting is the way you want, press the **F11** TEMPO button to exit tempo setting.  
The tempo setting will be exited automatically if you do not perform any operation for some time.

## Creating a Build Up

The build up functions can be used to create build ups while pattern play is in progress, to apply effects and build ups that are characteristic of dance music.

Function Name	Description	Remarks
PITCH	Each press of a keyboard key changes the overall pitch of the song. Pressing the PITCH DOWN key lowers the pitch in semitone units, while PITCH UP raises the pitch in semitone units.	*1
CHANGE	Instantly changes the pattern phrase of the currently playing song.	*1
ROLL	Cuts out part of a song, repeats it, and applies fine performance effects.	*2
FILTER	Applies effects that make notes darker (by cutting high-range frequencies) or brighter (by cutting low-range frequencies).	*2
GATE	Applies an effect that finely chops a song.	*2
ENDING	Ends the currently playing song while applying various effects.	*2

\*1 Depending on the part, some pattern phrases are not changed.

\*2 How an effect is applied changes randomly with each keyboard key press. Effects are applied for a fixed amount of time. The keys and the on-screen keyboard key indicators of the pattern phrase flash to indicate that an effect is being applied.

#### NOTE

- The auto build up function is executed from the next note immediately after a keyboard key is pressed.
- Though effects and the build up function can be used at the same time, the effect currently being executed may stop.
- The display shows the applicable function name while build up functions are being used.

## Dance Music Mode Settings

### Dance Music Volume (DM Vol.) Setting

See “Using the **FUNCTION** Button (**F12**)” (page EN-4).

### Dance Music Sync Type (DM Sync) Setting

See “Using the **FUNCTION** Button (**F12**)” (page EN-4).

### Dance Music Tempo (DM Tempo) Setting

See “Using the **FUNCTION** Button (**F12**)” (page EN-4).

### Dance Music Tone (DM Tone) Setting

See “Using the **FUNCTION** Button (**F12**)” (page EN-4).

## Playing Built-in Songs

With this Digital Keyboard, built-in music data is referred to as “songs”. You can play back songs for your listening pleasure, or for play-along practice.

### NOTE

- In addition to simple listening enjoyment, the built-in songs can be used with the lesson system (page EN-14) for practice.
- Though the Digital Keyboard does not support use of a sustain pedal, the sustain pedal symbol may appear in the on-screen musical notation of a song.

## Playing Back a Particular Song

Use the procedure below to play back one of the built-in songs. You can play along on the keyboard with song playback.

### Start/Stop

1. Press **8** **SONG BANK**.
2. Use **9** (10-key) to enter the number of the song you want.
  - See page A-4 for a complete list of available songs.
3. Press **4** **START/STOP**.  
This starts playback of the song.
4. Press **4** **START/STOP** again to stop playback.

### Pause

1. Press **3** **PAUSE**.  
This pauses song playback.
2. Press **3** **PAUSE** again to resume playback from the point where you paused it.

## Changing Playback Speed (Tempo)

1. Press the **TEMPO** button.  
This displays current tempo value along with the text "TEMPO".
2. Use the **9** (10-key) [-] and [+] keys to change the tempo value.
3. After the setting is the way you want, press the **TEMPO** button to exit tempo setting.
  - The tempo setting will be exited automatically if you do not perform any operation for some time.
  - Changing the song number will return the selected song to its original default tempo.

## Adjusting the Song Volume

See "Using the **FUNCTION** Button (**12**)" (page EN-4).

## Playing with the Same Tone as Song Playback

The same tone used by the song is assigned to the keyboard so you can play along with the song on the keyboard.

1. Hold down **6 TONE** until the name of the tone used by the selected song appears on the display.
  - If your currently selected tone is the same as the song tone, the display contents will not change.
2. Play along with the song playback.

### NOTE

- If you select a song that uses different tones for left and right hand play, the right hand part tone is assigned to the keyboard.

## Turning Off the Part of One Hand for Practice (Part Select)

You can turn off the right hand part or the left hand part of a song during playback and practice playing the along with the remaining part. Use this capability when you feel that a song is initially too difficult for you to play with both hands at the same time.

1. Press **5 PART SELECT** to select the part you want to turn off.  
Each press of **5 PART SELECT** cycles through the settings shown below.

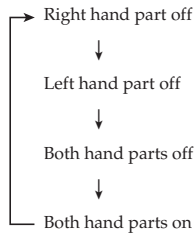

2. Press **4 PLAY/STOP, START/STOP**.  
This starts playback in accordance with the setting you selected in step 1.

# Using Built-in Songs to Master Keyboard Play

The methods you can use for practice with this Digital Keyboard are described below.

## ● Easy Mode

Press keyboard keys as they light. The melody plays as keys are pressed, regardless of which keys are pressed. This is a good way for beginners to master key press timing while enjoying playing on the keyboard.

## ● Lesson Lite

With this type of lesson, notes appear on the display screen. Play notes on the keyboard in accordance with the instructions provided by Voice Fingering Guide. Don't worry if you play the wrong note. Accompaniment play will wait until you play the correct note so there is no need to hurry.

## Easy Mode

1. Select the song you want to practice (page EN-12).
2. Press **5 PART SELECT** to select a part to practice.
  - Pressing **5 PART SELECT** in the Easy Mode returns to right-hand part practice without displaying the playback screen of both hand parts.
3. Press **13 EASY MODE**.
  - After an introductory count (and the intro part of the tune, if there is one), the keyboard stands by and waits for you to play the first note.
4. Press any key on the keyboard.
  - During the initial count or intro, the keyboard key that you need to press first will flash. During lesson play, the next key you need to press will flash. The flashing stops and the key remains lit when the time comes to press the key and play the note.
  - Accompaniment (or the left-hand part) waits until you press the flashing keyboard key.
  - Note that the correct note will play and accompaniment will advance, even if you accidentally press multiple keys. Even if you press multiple keys, the accompaniment will advance only one note.
5. To exit the Easy Mode, press **13 EASY MODE** (or **4 PLAY/STOP, START/STOP**).

## Lesson Lite

1. Select the song you want to practice (page EN-12).
2. Press **14 LESSON LITE**.
3. Play notes on the keyboard in accordance with the instructions provided on the display and by Voice Fingering Guide.

With this type of lesson, notes appear on the display screen. Voice Fingering Guide uses a simulate voice to announce which finger you should use.

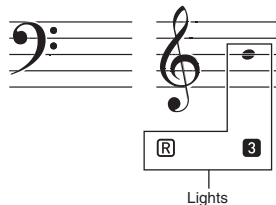

Accompaniment will wait for you to play the correct note.

- On-screen notation and sound will tell you which notes to play.
- Voice Fingering Guide will announce which finger you should use.

4. To stop the lesson, press **14 LESSON LITE** (or **4 PLAY/STOP, START/STOP**).

- If you complete lesson play to the end, a score that rates your play will appear on the screen.

Bravo!	You pass!
Again!	Go back and try again.

## Settings You Can Use During Lesson Lite

### Turning Off Voice Fingering Guide (Speak)

See "Using the **FUNCTION** Button (**12**)" (page EN-4).

### Turning Off Note Guide (NoteGuid)

See "Using the **FUNCTION** Button (**12**)" (page EN-4).

### Turning Off Performance Evaluation (Scoring)

See "Using the **FUNCTION** Button (**12**)" (page EN-4).



## Using Auto Accompaniment

With Auto Accompaniment, simply select an accompaniment pattern. Each time you play a chord with your left hand the appropriate accompaniment will play automatically. It's like having a personal backup group along with you wherever you go.

### NOTE

- Auto Accompaniments are made up of the following three parts.
  - (1) Rhythm
  - (2) Bass
  - (3) Harmony

You can have only the rhythm part play, or you can have all three parts play at the same time.

## Playing the Rhythm Part only

The rhythm part is the foundation of each Auto Accompaniment. Your Digital Keyboard comes with a variety of built-in rhythms, including 8-beat and waltz. Use the following procedure to play the basic rhythm part.

### Starting and Stopping the Rhythm Part only

1. Press **7** RHYTHM.
2. Use **9** (10-key) to select the rhythm number you want.
  - For information about rhythm types, see the "Rhythm List" (page A-3).
3. Press **4** START/STOP.  
This starts the rhythm.
4. Play along with the rhythm.
5. To stop the rhythm, press **4** START/STOP again.

### Changing the Tempo

You can use the tempo setting operation to change the tempo of pattern play. See "Changing Playback Speed (Tempo)" (page EN-13).

## Playing All Parts

### Auto Accompaniment with Chords

Playing a chord with your left hand automatically adds bass and harmony accompaniment parts to the currently selected rhythm. It is just like having your own personal backup group on call.

1. Start play of the Auto Accompaniment rhythm part.
2. Press **5** ACCOMP.  
This enables chord input on the accompaniment keyboard.

Accompaniment keyboard



3. Use the accompaniment keyboard to play chords.  
This will cause bass and harmony Auto Accompaniment parts to be added to the rhythm part.
4. Play other chords with left hand as you play the melody with your right hand.
5. Pressing **5** ACCOMP again returns to rhythm only accompaniment.

## Selecting a Chord Input Mode

You can select from among the following five chord input modes.

- FINGERED 1
- FINGERED 2
- FINGERED 3
- CASIO CHORD
- FULL RANGE CHORD

1. Hold down **[5]** **[↓]** **CHORDS** until the chord input mode selection screen appears on the display.

2. Use the **[9]** (10-key) **[-]** and **[+]** keys to select the chord input mode you want.

### ■ FINGERED 1, 2, and 3

With these three input modes, you play chords on the accompaniment keyboard using their normal chord fingerings. Some chord forms are abbreviated, and can be fingered with one or two keys.

See page A-6 for information about chords that are supported and how they are fingered on the keyboard.

#### ● FINGERED 1

Play the component notes of the chord on the keyboard.

#### ● FINGERED 2

Unlike FINGERED 1, 6th input is not possible.

#### ● FINGERED 3

Unlike FINGERED 1, allows input of fraction chords with the lowest keyboard note as the bass note.

### ■ CASIO CHORD

With CASIO CHORD, you can use simplified fingerings to play the four types of chords described below.

#### Chord Type

##### Major Chords

Pressing a single accompaniment area key in the CASIO CHORD mode will play the major chord whose name is marked above the key. All of the accompaniment area keys that are marked with the same chord name play exactly the same chord.

Example: C (C Major)



##### Minor Chords

To play a minor chord, press the accompaniment area key that corresponds to the major chord, while also pressing one other accompaniment area key to the right.

Example: Cm (C Minor)



##### Seventh Chords

To play a seventh chord, press the accompaniment area key that corresponds to the major chord, while also pressing two other accompaniment area keys to the right.

Example: C7 (C Seventh)



##### Minor Seventh Chords

To play a minor seventh chord, press the accompaniment area key that corresponds to the major chord, while also pressing three other accompaniment area keys to the right.

Example: Cm7 (C Minor Seventh)



#### NOTE

- When playing a minor, seventh, or minor seventh chord, it makes no difference whether the additional keys you press are black or white.

### ■ FULL RANGE CHORD

With this mode, you can use the full range of the keyboard to play chords and the melody.

See page A-6 for information about chords that are supported.

## Using Auto Accompaniment Effectively

### Varying Play during a Performance

You can insert Auto Accompaniment fill-ins (variations) to make your performances more interesting and lively.

1. While playing with Auto Accompaniment, press the **3 SYNCHRO/FILL-IN** button.  
This will play a one-measure fill in and then return to normal Auto Accompaniment.

### Starting Play with Synchro Start

With Synchro Start, you can have Auto Accompaniment start when you play something on the keyboard.

1. While Auto Accompaniment play is stopped, press the **3 SYNCHRO/FILL-IN** button.
2. Play a chord on the keyboard.  
This starts Auto Accompaniment play.

### Changing Auto Accompaniment Volume

See “Using the **FUNCTION** Button (**12**)” (page EN-4).

## Connecting External Devices

### Connecting to Audio Equipment

You can connect the digital piano to a commercially available stereo system or amplifier, or to a recording device.

### Outputting Digital Keyboard Notes to Audio Equipment

Connect a commercially available connection cord to the **28 PHONES/OUTPUT** jack.

- The connecting cord should have a stereo standard plug on one end and a plug that matches the configuration of the input jack of the external device on the other end.

### IMPORTANT!

- Turn off the external device when making connections. After connecting, turn down the Digital Keyboard and external device volume levels whenever turning power on or off.
- After connecting, turn on the Digital Keyboard and then the external device.
- If Digital Keyboard notes sound distorted when they are sounded from external audio equipment, lower the Digital Keyboard's volume setting.

## Troubleshooting

Symptom	Action
<b>Included Accessories</b>	
I can't find something that should be here.	Carefully check inside all of the packing materials.
<b>Power Requirements</b>	
Power will not turned on.	<ul style="list-style-type: none"> <li>• Check the AC adaptor or make sure that the batteries are facing correctly (page EN-7).</li> <li>• Replace the batteries with new ones or switch over to AC adaptor power (page EN-7).</li> </ul>
The Digital Keyboard outputs a loud sound and then suddenly powers down.	Replace the batteries with new ones or switch over to AC adaptor power (page EN-7).
The Digital Keyboard suddenly powers down after 30 minutes.	This happens when Auto Power Off (page EN-4) is triggered.
<b>Display</b>	
If I don't play anything for a few minutes, keyboard keys suddenly start flashing. Things return to normal after I press a keyboard key or a button.	Turn off the power on alert feature (page EN-4).
The display keeps going out or are flashing.	Replace the batteries with new ones or switch over to AC adaptor power (page EN-7).
On-screen keyboard keys or notes remain on the display.	A Lesson Lite is in progress and the Digital Keyboard is waiting for you to play the next note in the song. To stop this from happening, cancel the lesson (page EN-14).
Screen contents are visible only from straight ahead.	This is dues to production limitations. It does not indicate malfunction.
<b>Sound</b>	
Nothing happens when I press any keyboard key.	<ul style="list-style-type: none"> <li>• Adjust the main volume setting (page EN-8).</li> <li>• Check if something is plugged into the <b>PHONES/OUTPUT</b> jack (23) on the back of the Digital Keyboard.</li> <li>• Turn power off and then back on to initialize all Digital Keyboard settings (page EN-8).</li> </ul>
Nothing happens or notes do not play normally when I play notes on the left side of the keyboard.	Press <b>5 ACCOMP</b> to disable chord input in the accompaniment keyboard area (page EN-15).
Nothing happens when I start an Auto Accompaniment.	<ul style="list-style-type: none"> <li>• With rhythms 69 and 70, nothing will sound if you do not play a chord on the keyboard. Try playing a chord (page EN-16).</li> <li>• Check and adjust the accompaniment volume setting (page EN-17).</li> <li>• Turn power off and then back on to initialize all Digital Keyboard settings (page EN-8).</li> </ul>
Nothing happens when I start playback of a built-in song.	<ul style="list-style-type: none"> <li>• It takes a little time after you press the button until the song starts to play. Wait for a moment for the song to start.</li> <li>• Check and adjust the song volume (page EN-13).</li> <li>• Turn power off and then back on to initialize all Digital Keyboard settings (page EN-8).</li> </ul>
Notes keep sounding, without stopping.	<ul style="list-style-type: none"> <li>• Turn power off and then back on to initialize all Digital Keyboard settings (page EN-8).</li> <li>• Replace the batteries with new ones or switch over to AC adaptor power (page EN-7).</li> </ul>
Some notes are cut off while they are playing.	Notes are cut off whenever the number of notes being sounded exceeds the maximum polyphony value of 32 (16 for some tones). This does not indicate malfunction.

Symptom	Action
The volume or tone setting I made has changed.	<ul style="list-style-type: none"> <li>Adjust the main volume setting (page EN-8).</li> <li>Turn power off and then back on to initialize all Digital Keyboard settings (page EN-8).</li> <li>Replace the batteries with new ones or switch over to AC adaptor power (page EN-7).</li> </ul>
In certain keyboard ranges, the volume and tone quality sound are slightly different from those in other keyboard ranges.	This is due to system limitations. It does not indicate malfunction.
With some tones, octaves do not change at the far ends of the keyboard.	This is due to system limitations. It does not indicate malfunction.
The pitch of the notes does not match other accompanying instruments or sounds strange when played along with other instruments.	<ul style="list-style-type: none"> <li>Check and adjust the transpose (page EN-4) and tuning settings (page EN-4).</li> <li>Turn power off and then back on to initialize all Digital Keyboard settings (page EN-8).</li> </ul>
The reverb of notes seems to change suddenly.	Turn power off and then back on to initialize all Digital Keyboard settings (page EN-8).

## Returning the Digital Keyboard to Its Factory Default Settings

Perform the following procedure when you want to return the Digital Keyboard's stored data and settings to their initial factory defaults.

- Turn off the Digital Keyboard.
- While holding down **8** SONG BANK and the [0] 10-key (**9**) key at the same time, press **1**  (Power).
  - You will be able to use the Digital Keyboard in a short while after its system is initialized.

## Specifications

<b>Model</b>	LK-135/LK-136
<b>Keyboard</b>	61 keys
<b>Key Lighting</b>	Maximum number of keys simultaneously lit: 4
<b>Maximum Polyphony</b>	32 notes
<b>Tones</b>	
Preset Tones	120
<b>Effects</b>	Dance Music effects
<b>Song Bank</b>	
Preset Songs	100
<b>Easy Mode</b>	
Lesson Parts	Left hand, right hand, both hands
<b>Lesson Lite</b>	
Lesson Parts	Left hand, right hand, both hands
Other	Voice Fingering Guide, Note Guide, Performance Evaluation
<b>Auto Accompaniment</b>	
Preset Rhythms	70 types
<b>Dance Music Mode</b>	
Preset Patterns	50 types
<b>Demo Function</b>	Looped play of the dance music demo (1 song) and built-in Song Bank (100 songs)
<b>Other Functions</b>	
Transpose	±1 octave (-12 to 0 to +12 semitones)
Tuning	A4 = 415.5 to 465.9Hz (Initial Default: 440.0Hz)
<b>Musical Information System</b>	Tone, Auto Accompaniment, Song Bank numbers and names; staff notation; fingering guide; tempo; measure number, beat; chord name, etc.
<b>Jacks</b>	
PHONES/OUTPUT jack	Stereo standard jack × 1 Output impedance: 140 Ω; Output voltage: 4.5 V (RMS) MAX
<b>AC adaptor terminal</b>	9.5 V DC
<b>Power Requirements</b>	2-Way Power
Batteries	Six AA-size manganese batteries or AA-size alkaline batteries
Battery Life	Approximately 6 hours (on alkaline batteries)
AC Adaptor	AD-E95100L
Auto Power Off	Approximately 30 minutes after last operation; Can be disabled.
<b>Speakers</b>	10cm × 2 (Output: 2.0W+2.0W)
<b>Power Consumption</b>	9.5V $\overline{\text{---}}$ 5.5W
<b>Dimensions</b>	94.6 (W) × 30.7 (D) × 9.2 (H) cm (37 <sup>1</sup> / <sub>4</sub> × 12 <sup>1</sup> / <sub>8</sub> × 3 <sup>5</sup> / <sub>8</sub> inch)
<b>Weight (Excluding batteries)</b>	Approximately 3.5 kg (7.7 lbs)

- Design and specifications are subject to change without notice.

## Operating Precautions

Be sure to read and observe the following operating precautions.

### ■ Location

Avoid the following locations for this product.

- Areas exposed to direct sunlight and high humidity
- Areas subjected to temperature extremes
- Near a radio, TV, video deck, or tuner

The above devices will not cause malfunction of the product, but interference from the product can cause audio or video interference of a nearby device.

### ■ User Maintenance

- Never use benzine, alcohol, thinner, or other chemical agents to clean the product.
- To clean the product or its keyboard, wipe with a soft cloth moistened in a weak solution of water and a mild neutral detergent. Wring all excess moisture from the cloth before wiping.

### ■ Included and Optional Accessories

Use only accessories that are specified for use with this product. Use of unauthorized accessories creates the risk of fire, electric shock, and personal injury.

### ■ Weld Lines

Lines may be visible on the exterior of the product. These are “weld lines” that result from the plastic molding process. They are not cracks or scratches.

### ■ Musical Instrument Etiquette

Always be aware of others around you whenever using this product. Be especially careful when playing late at night to keep the volume at levels that do not disturb others. Other steps you can take when playing late at night are closing the window and using headphones.

# Appendix/Apéndice

## Tone List/Lista de tonos

No./N°	Tone Name/ Nombre del tono
<b>PIANO/E.PIANO</b>	
001	GRAND PIANO
002	BRIGHT PIANO
003	HONKY-TONK
004	ELEC.GRAND PIANO
005	ELEC.PIANO 1
006	ELEC.PIANO 2
007	60'S E.PIANO
008	CHORUS E.PIANO
009	HARPSICHORD
010	CLAVI
<b>CHROMATIC PERC.</b>	
011	CELESTA
012	GLOCKENSPIEL
013	MUSIC BOX
014	VIBRAPHONE
015	MARIMBA
016	TUBULAR BELL
<b>ORGAN</b>	
017	DRAWBAR ORGAN
018	PERC.ORGAN
019	ROCK ORGAN
020	PIPE ORGAN
021	REED ORGAN
022	ACCORDION
023	HARMONICA
024	BANDONEON
<b>GUITAR</b>	
025	NYLON STR.GUITAR
026	STEEL STR.GUITAR
027	JAZZ GUITAR
028	CLEAN GUITAR
029	MUTE GUITAR
030	DISTORTION GUITAR
<b>BASS</b>	
031	ACOUSTIC BASS
032	FINGERED BASS
033	PICKED BASS
034	FRETLESS BASS
035	SAW SYNTH-BASS
036	SQUARE SYNTH-BASS
<b>STR/ORCHESTRA</b>	
037	VIOLIN
038	VIOLA
039	CELLO
040	CONTRABASS
041	PIZZICATO STRINGS
042	HARP
043	TIMPANI
<b>ENSEMBLE</b>	
044	STRINGS
045	SLOW STRINGS
046	SYNTH-STRINGS
047	CHOIR AAHS
048	SYNTH-VOICE
049	ORCHESTRA HIT
<b>BRASS</b>	
050	TRUMPET
051	TROMBONE
052	TUBA
053	FRENCH HORN
054	BRASS
055	SYNTH-BRASS
<b>REED</b>	
056	SOPRANO SAX
057	ALTO SAX
058	TENOR SAX
059	BARITONE SAX
060	OBOE
061	CLARINET

No./N°	Tone Name/ Nombre del tono
<b>PIPE</b>	
062	PICCOLO
063	FLUTE
064	RECORDER
065	BOTTLE BLOW
066	WHISTLE
067	OCARINA
<b>SYNTH-LEAD</b>	
068	SQUARE LEAD
069	SAW LEAD
070	VOICE LEAD
071	FIFTH LEAD
072	BASS+LEAD
073	DANCE SQUARE LEAD
074	DANCE SYNC SQUARE LEAD
075	DANCE SAW LEAD
076	DANCE SYNC SAW LEAD
077	DANCE SAW BASS
<b>SYNTH-PAD</b>	
078	FANTASY
079	WARM PAD
080	POLYSYNTH
081	SPACE CHOIR
082	METAL PAD
083	HALO PAD
084	RAIN DROP
085	SOUND TRACK
086	CRYSTAL
087	ATMOSPHERE
088	BRIGHTNESS
089	SF
090	DANCE SAW PAD
091	DANCE SQUARE PAD
<b>ETHNIC</b>	
092	SITAR 1
093	SITAR 2
094	TANPURA 1
095	TANPURA 2
096	HARMONIUM 1
097	HARMONIUM 2
098	SHANAI 1
099	SHANAI 2
100	SANTUR 1
101	SANTUR 2
102	TABLA
103	BANJO
104	SHAMISEN
105	KOTO
106	BAGPIPE
107	FIDDLE
<b>VARIOUS</b>	
108	TINKLE BELL
109	STEEL DRUMS
110	SYNTH-DRUM
111	STRINGS PIANO
112	BASS/PIANO
113	SYNTH-VOICE & E.PIANO
114	STEEL GUITAR PAD
115	SE 1
116	SE 2
<b>DRUM SET</b>	
117	STANDARD SET
118	DANCE SET
119	BRUSH SET
120	INDIAN SET



## Drum Assignment List/Lista de asignación de batería

Key/ Clave	Note No./ Nº de nota	DRUMS SET NAME			
		STANDARD SET	DANCE SET	BRUSH SET	INDIAN SET
C-1	0				
D-1	1				
E-1	2				
F-1	3				
G-1	4				
A-1	5				
B-1	6				
C0	7				
D0	8				
E0	9				
F0	10				
G0	11				
A0	12				
B0	13				
C1	14				
D1	15				
E1	16				
F1	17				
G1	18				
A1	19				
B1	20				
C2	21				
D2	22				
E2	23				
F2	24				
G2	25				
A2	26				
B2	27				
C3	28				
D3	29				
E3	30				
F3	31				
G3	32				
A3	33				
B3	34				
C4	35				
D4	36				
E4	37				
F4	38				
G4	39				
A4	40				
B4	41				
C5	42				
D5	43				
E5	44				
F5	45				
G5	46				
A5	47				
B5	48				
C6	49				
D6	50				
E6	51				
F6	52				
G6	53				
A6	54				
B6	55				
C7	56				
D7	57				
E7	58				
F7	59				
G7	60				
A7	61				
B7	62				
C8	63				
D8	64				
E8	65				
F8	66				
G8	67				
A8	68				
B8	69				
C9	70				
D9	71				
E9	72				
F9	73				
G9	74				
A9	75				
B9	76				
C10	77				
D10	78				
E10	79				
F10	80				
G10	81				
A10	82				
B10	83				
C11	84				
D11	85				
E11	86				
F11	87				
G11	88				
A11	89				
B11	90				
C12	91				
D12	92				
E12	93				
F12	94				
G12	95				
A12	96				
B12	97				
C13	98				
D13	99				
E13	100				
F13	101				
G13	102				
A13	103				
B13	104				
C14	105				
D14	106				
E14	107				
F14	108				
G14	109				
A14	110				
B14	111				
C15	112				
D15	113				
E15	114				
F15	115				
G15	116				
A15	117				
B15	118				
C16	119				
D16	120				
E16	121				
F16	122				
G16	123				
A16	124				
B16	125				
C17	126				
D17	127				

- “←” indicates a key is assigned the same tones as it is for STANDARD SET.
- “←” indica una clave asignada a los mismos tonos que para STANDARD SET.

## Rhythm List/Lista de ritmos

No./N°	Rhythm name/ Nombre del ritmo
<b>8 BEAT</b>	
01	STRAIGHT 8 BEAT
02	8 BEAT
<b>16 BEAT</b>	
03	16 BEAT
04	16 BEAT SHUFFLE 1
05	16 BEAT SHUFFLE 2
<b>BALLAD</b>	
06	MODERN BALLAD
07	16 BEAT BALLAD
08	POP BALLAD
09	6/8 BALLAD
<b>DANCE</b>	
10	EDM 1
11	EDM 2
12	DISCO POP
13	MODERN R&B
<b>POPS</b>	
14	POP
15	POP ROCK
16	60's SOUL
<b>ROCK</b>	
17	STRAIGHT ROCK
18	SHUFFLE ROCK
19	LATIN ROCK
20	SLOW ROCK
21	ROCK WALTZ
<b>JAZZ</b>	
22	BIG BAND
23	SLOW SWING
24	JAZZ WALTZ
25	FOX TROT
<b>EUROPEAN</b>	
26	POLKA
27	WALTZ 1
28	SLOW WALTZ
29	VIENNESE WALTZ
30	FRENCH WALTZ
31	TANGO
32	MARCH 1
33	MARCH 2
<b>LATIN</b>	
34	BOSSA NOVA
35	SAMBA
36	MAMBO
37	SALSA
38	REGGAE
39	POP REGGAE
40	SKA
<b>WORLD</b>	
<b>INDIAN</b>	
41	BHANGRA
42	DADRA
43	GARBA
44	KEHARWA
45	TEEN TAAL
46	DANDIYA
47	BHAJAN
48	INDIAN POP 1
49	INDIAN POP 2

No./N°	Rhythm name/ Nombre del ritmo
50	QAWWALI
51	KERALA
52	RAJASTHANI
<b>AMERICAN</b>	
53	COUNTRY BALLAD
54	BLUEGRASS
55	DIXIE
56	TEX-MEX
57	FAST GOSPEL
58	HAWAIIAN
<b>SPANISH/EASTERN EUROPEAN</b>	
59	RUSSIAN CHANSON
<b>ARABIC/ORIENTAL</b>	
60	ADANI
<b>CHINESE</b>	
61	JIANGNAN
62	DONGBEIYANGGE
63	JINGJU
64	HUANGMEIXI
65	MIAOZU
66	XINJIANG
<b>VARIOUS</b>	
67	CHRISTMAS WALTZ
68	STR QUARTET
<b>PIANO RHYTHMS</b>	
69	ARPEGGIO
70	WALTZ 2

## Song List/Lista de canciones

No./ Nº	Title/Título
<b>WORLD</b>	
001	TWINKLE TWINKLE LITTLE STAR
002	LIGHTLY ROW
003	LONG LONG AGO
004	ON TOP OF OLD SMOKEY
005	SAKURA SAKURA
006	WHEN THE SAINTS GO MARCHING IN
007	AMAZING GRACE
008	AULD LANG SYNE
009	COME BIRDS
010	DID YOU EVER SEE A LASSIE?
011	MICHAEL ROW THE BOAT ASHORE
012	DANNY BOY
013	MY BONNIE
014	HOME SWEET HOME
015	AURA LEE
016	HOME ON THE RANGE
017	ALOHA OE
018	SANTA LUCIA
019	FURUSATO
020	GREENSLEEVES
021	JOSHUA FOUGHT THE BATTLE OF JERICO
022	THE MUFFIN MAN
023	LONDON BRIDGE
024	UNDER THE SPREADING CHESTNUT TREE
025	SIPPIN' CIDER THROUGH A STRAW
026	GRANDFATHER'S CLOCK
027	ANNIE LAURIE
028	BEAUTIFUL DREAMER
029	IF YOU'RE HAPPY AND YOU KNOW IT, CLAP YOUR HANDS
030	MY DARLING CLEMENTINE
031	LITTLE BROWN JUG
032	HOUSE OF THE RISING SUN
033	SHE WORE A YELLOW RIBBON
034	YANKEE DOODLE
035	MY OLD KENTUCKY HOME
036	SZLA DZIEWECZKA
037	TROIKA
038	WALTZING MATILDA
039	ON THE BRIDGE OF AVIGNON
040	I'VE BEEN WORKING ON THE RAILROAD
041	OHI SUSANNA
042	CAMPTOWN RACES
043	JEANNIE WITH THE LIGHT BROWN HAIR
044	TURKEY IN THE STRAW
045	JAMAICA FAREWELL
<b>EVENT</b>	
046	SILENT NIGHT
047	WE WISH YOU A MERRY CHRISTMAS
048	JINGLE BELLS
049	JOY TO THE WORLD
050	O CHRISTMAS TREE
<b>PIANO/CLASSICS</b>	
051	MARY HAD A LITTLE LAMB
052	LE CYGNE FROM "LE CARNAVAL DES ANIMAUX"
053	JE TE VEUX
054	SONATA op.13 "PATHÉTIQUE" 2nd Mov.
055	HEIDENRÖSLEIN
056	AIR FROM "SUITE no.3"
057	SPRING FROM "THE FOUR SEASONS"
058	HABANERA FROM "CARMEN"
059	BRINDISI FROM "LA TRAVIATA"
060	HUNGARIAN DANCES no.5

No./ Nº	Title/Título
061	MINUET IN G MAJOR
062	MUSETTE IN D MAJOR
063	GAVOTTE (GOSSEC)
064	ARABESQUE (BURGMULLER)
065	CHOPSTICKS
066	DECK THE HALL
067	ODE TO JOY
068	AVE MARIA (GOUNOD)
069	SONATINA op.36 no.1 1st Mov.
070	PRELUDE op.28 no.7 (CHOPIN)
071	RÉVERIE
072	GYMNOPÉDIES no.1
073	GOING HOME FROM "FROM THE NEW WORLD"
074	FUR ELISE
075	TURKISH MARCH (MOZART)
076	SONATA op.27 no.2 "MOONLIGHT" 1st Mov.
077	ETUDE op.10 no.3 "CHANSON DE L'ADIEU"
078	THE ENTERTAINER
079	WEDDING MARCH FROM "MIDSUMMER NIGHT'S DREAM"
080	AMERICAN PATROL
081	FÖRHLICHER LANDMANN
082	LA CHEVALERESQUE
083	SONATA K.545 1st Mov.
084	LA PRIÈRE D'UNE VIERGE
085	VALSE op.64 no.1 "PETIT CHIEN"
086	LIEBESTRÄUME no.3
087	JESUS BLEIBET MEINE FREUDE
088	CANON (PACHELBEL)
089	SERENADE FROM "EINE KLEINE NACHTMUSIK"
090	MARCH FROM "THE NUTCRACKER"
091	CHANSON DU TOREADOR FROM "CARMEN"
092	LARGO (HÄNDEL)
093	INNOCENCE
094	PROMENADE FROM "TABLEAUX D'UNE EXPOSITION"
095	INVENTIONEN no.1
096	PRÆLUDIUM no.1 (J.S.BACH)
097	DOLLY'S DREAMING AND AWAKENING
098	LA FILLE AUX CHEVEUX DE LIN
099	TRÄUMEREI
100	NOCTURNE op.9 no.2 (CHOPIN)

## Dance Music Mode List/ Lista de modos de música de danza

No./N°	Title/Título
<b>EDM</b>	
01	ELECTRO DANCE 1
02	ELECTRO DANCE 2
03	ELECTRO DANCE 3
04	BIG BEAT TECHNO 1
05	BIG BEAT TECHNO 2
06	SPEED SHUFFLE 1
07	SPEED SHUFFLE 2
08	POP TRANCE 1
09	POP TRANCE 2
10	SLOW SOUL 1
11	DIGITAL SHUFFLE 1
12	DIGITAL SHUFFLE 2
13	POWER POP 1
14	POWER POP 2
15	POWER POP 3
16	NEO TRANCE 1
17	NEO TRANCE 2
18	HARD SHUFFLE 1
19	HARD SHUFFLE 2
20	ELECTRO BOUNCE 1
21	ELECTRO BOUNCE 2
22	POWER ELECTRO 1
23	POWER ELECTRO 2
24	ACID DANCE
25	POWER DANCE 1
26	POWER DANCE 2
27	FUTURE DANCE
28	DANCE RAGGA
29	ACID ELECTRO 1
30	ACID ELECTRO 2
31	HARD ELECTRO
32	ACID TECHNO 1
33	ACID TECHNO 2
34	FANTASTIC DANCE
35	FUTURE POP
<b>HOUSE</b>	
36	ELECTRIC POP
37	DIGITAL SHUFFLE 3
38	POP DANCE 1
39	POP DANCE 2
40	FUTURE HOUSE 1
41	FUTURE HOUSE 2
42	SPEED HOUSE 1
43	SPEED HOUSE 2
44	URBAN DANCE 1
45	URBAN DANCE 2
<b>HIP-HOP</b>	
46	DEEP SOUL 1
47	DEEP SOUL 2
48	SLOW SOUL 2
49	ELECTRO BOUNCE 3
50	ELECTRO RAGGA

## Fingering Guide/ Guía de digitación

### Fingered 1, Fingered 2 Chords/ Acordes Fingered 1, Fingered 2

<b>C</b>	
<b>Cm</b>	
<b>Cdim</b>	
<b>Caug</b> *3	
<b>Csus4</b> *3	
<b>Csus2</b> *3	
<b>C7</b>	
<b>Cm7</b> *3	
<b>CM7</b>	
<b>Cm7<sup>b</sup>5</b> *3	
<b>C7<sup>b</sup>5</b> *3	
<b>C7sus4</b>	
<b>Cadd9</b>	
<b>Cmadd9</b>	
<b>CmM7</b>	
<b>Cdim7</b> *3	
<b>C69</b> *3	
<b>C6</b> *1 *3	
<b>Cm6</b> *2 *3	

- \*1 With Fingered 2, interpreted as Am7.
- \*2 With Fingered 2, interpreted as Am7<sup>b</sup>5.
- \*3 Inverted form not supported in some cases.

- \*1 Con Fingered 2, se interpreta como Am7.
- \*2 Con Fingered 2, se interpreta como Am7<sup>b</sup>5.
- \*3 En algunos casos no se puede usar la forma invertida.

### Fingered 3, Full Range Chords/ Acordes Fingered 3, Full Range

In addition to the chords that can be fingered with Fingered 1 and Fingered 2, the following chords also are recognized.

Además de los acordes que se pueden digitar con Fingered 1 y Fingered 2, también se pueden reconocer los siguientes acordes.

$\frac{C\#}{C}$	$\frac{D}{C}$	$\frac{E}{C}$	$\frac{F}{C}$	$\frac{G}{C}$	$\frac{A^b}{C}$	$\frac{B^b}{C}$	$\frac{B}{C}$	$\frac{C\#m}{C}$	$\frac{Dm}{C}$	$\frac{Fm}{C}$
$\frac{Gm}{C}$	$\frac{Am}{C}$	$\frac{B^bm}{C}$	$\frac{Ddim}{C}$	$\frac{A^b7}{C}$	$\frac{F7}{C}$	$\frac{Fm7}{C}$	$\frac{Gm7}{C}$	$\frac{A^badd9}{C}$		

#### NOTE

- With Fingered 3, the lowest note fingered is interpreted as the base note. Inverted forms are not supported.
- With Full Range Chord, when the lowest note fingered is a certain distance from the neighboring note, the chord is interpreted as a fraction chord.
- Unlike Fingered 1, 2, and 3, Full Range Chord requires pressing of at least three keys to form a chord.

#### NOTA

- Con Fingered 3, la nota más baja digitada se interpreta como nota base. No se pueden usar formas invertidas.
- Con Full Range Chord, cuando la nota digitada más baja se encuentre a cierta distancia de la nota adyacente, el acorde se interpreta como un acorde bitonal.
- A diferencia de Fingered 1, 2, y 3, Full Range Chord requiere la pulsación de tres teclas como mínimo para formar un acorde.

## Chord Example List/Lista de ejemplos de acordes

Root Chord Type	C	C <sup>7</sup> /(D <sup>7</sup> )	D	(D <sup>7</sup> )/E <sup>7</sup>	E	F	F <sup>7</sup> /(G <sup>7</sup> )	G	(G <sup>7</sup> )/A <sup>7</sup>	A	(A <sup>7</sup> )/B <sup>7</sup>	B
M												
m												
dim												
aug												
sus4												
sus2												
7												
m7												
M7												
m7 <sup>5</sup>												
7 <sup>5</sup>												
7sus4												
add9												
madd9												
mM7												
dim7												
69												
6												
m6												

- Since the chord input range is limited, this model may not support some of the chords shown above.
- Debido a que el rango de entrada de acordes es limitado, es posible que este modelo no admita algunos de los acordes mostrados arriba.



This recycle mark indicates that the packaging conforms to the environmental protection legislation in Germany.

Esta marca de reciclaje indica que el empaquetado se ajusta a la legislación de protección ambiental en Alemania.

# CASIO®

 MA1608-A Printed in China



LK135-ES-1A

**CASIO COMPUTER CO., LTD.**  
6-2, Hon-machi 1-chome  
Shibuya-ku, Tokyo 151-8543, Japan

© 2016 CASIO COMPUTER CO., LTD.